

VAPolyMk5

Bitimbral Polyphonic Synthesizer



User Guide

Version 1.0

Table of Contents

Introduction	18
Privacy Settings	18
Main Features	18
System Requirements	19
Use as Stand Alone	19
Use as AudioUnit Extension (AUv3)	19
Factory Preset	19
User Preset	19
State Recovery	19
About MIDI Latency	19
Maximum Number of Touches	19
User Interface	21
Tool Bar	23
Controller	25
CH Control	25
OSC	26
OSC1	26
OSC2	26
OSC3	26
Noise	27
OSC1+	28
OSC2+	28
OSC3+	28
VCF	30
LPF	30
HPF	30
VCA	30
EG1	31
EG2	31

EG	32
EG3	32
LFO1	32
LFO2	32
Key Tracking	32
Effect	33
Step Sequencer	34
Mod	35
Sample & Hold	36
KBD Control Routing	37
Offset Control	38
Global Control	40
ARP	40
Aftertouch	40
Mod Wheel	40
LFO	40
Ring Mod	41
Morph	41
Delay	42
Chorus / Flanger	42
Reverb	42
EQ and Mixer	42
Compressor	43
Master Output	43
Chorus / Flanger	44
Reverb	44
Mixer	44
Compressor	44
Keyboard	46
Visualizer	47

Sequencer	49
Clip Editor	50
Piano Roll Editor	51
Parameter Automation Editor	52
Synthesizer	53
Block diagram	53
Control Signal & MIDI Flow	54
Oscillators	55
Tune	55
Fine	55
PW (Pulse Width)	55
Shape	55
Level	55
TZFM Amount	55
Hard Sync	55
FM EG	55
FM Amount	56
FM LFO	56
FM EG	56
PWM Amount	56
PWM LFO	56
PWM EG	56
TZFM Amount	56
TZFM LFO	56
TZFM EG	56
Transpose	57
Detune	57
Key Sync	57
Unison	57
Voices	57

Pitch Bend	57
Noise Type	57
Level	57
Low Pass Filter	58
Cutoff	58
Resonance	58
Mod Amount	58
Mod EG	58
Mod LFO	58
Key Follow	58
LPF Slope	58
Gain	58
Link	58
High Pass Filter	59
Cutoff	59
Resonance	59
Mod Amount	59
Mod EG	59
Mod LFO	59
Key Follow	59
VCA (Amplifier)	60
Volume	60
PAN	60
AM	60
Env	60
Pan LFO	60
AM LFO	60
ADSR (Envelope Generator)	61
Attack	61
Decay	61

Sustain	61
Release	61
Velocity	61
Key Follow	61
Delay	61
LFO	62
Tune	62
Shape	62
Delay	62
Tempo Sync	62
Key Sync (Key Re-Trigger)	62
Env Mod	62
Env Mod (LFO2)	62
Key Tracking	63
EG1 Break Point	63
EG1 Low	63
EG1 High	63
EG2 Break Point	63
EG2 Low	63
EG2 High	63
EFX Send	64
Delay Send	64
C/F Send	64
Reverb Send	64
Delay Pre/Post	64
C/F Pre/Post	64
Reverb Pre/Post	64
Output Mixer	65
Delay Level	65
C/F Level	65

Reverb Level	65
Master Output	65
Volume	65
Pan	65
Mute	65
Step Sequencer	66
Step Switch	66
Slide	66
Gate	66
CV	66
Play	67
Mode	67
Rate	67
Tempo Sync	67
Quantize	67
Steps	67
Gate	67
KBD Root	67
Root Key	67
Octave Range	67
CV 1...3	68
Clock Division 1...3	68
Mod Amount 1...3	68
Assign 1...3	68
Hold 1...3	69
Src Mix 1...3	69
Src 2	69
Mod Attack	69
Mod Release	69
Sync with Transport Control	70

KBD Control Routing	71
Global Control	72
Glide Time	72
FM Type	72
FM Range	72
ARP	72
Arp Pattern	72
Arp Rate	72
Gate	72
Arp Switch	72
Arp Tempo Sync	72
CH	72
LFO	73
Tune	73
Shape	73
Delay	73
Tempo Sync	73
Key Sync	73
Vibrato	73
Tremolo	73
LFO	73
CH	73
PW Amount	73
CF Amount	73
Pan Amount	73
Ring Modulator	74
Attack	74
Decay	74
Depth	74
Speed	74

Mod Amount	74
CH	74
Morph	75
Stereo	75
Mix	75
Mod	75
Offset Control	76
CH	76
Pitch	76
Mod	76
OSC 1...3 Pitch	76
OSC 1...3 Shape	76
OSC 1...3 PW	76
OSC 1...3 Level	76
Cutoff (LPF, HPF)	76
Resonance (LPF, HPF)	76
Mod (LPF, HPF)	76
VCA Level	76
Pan	76
AM	76
Delay	76
C/F	76
Reverb	76
ENV 1,2 Attack	76
ENV 1,2 Sustain	76
ENV 1,2 Release	76
Assignable Controllers	77
Effects	78
Delay	78
Signal Flow	78

Delay Time	78
Regeneration	78
Modulation	78
Chorus / Flanger	79
Signal Flow	79
Input Signal Level	79
Effect Type	79
Modulation Speed	79
Modulation Width	79
LFO Shape	79
Stereo Width	79
Regeneration	79
Filters	80
Reverb	81
Signal Flow	81
Input Filter	81
Pre Delay	81
Modulation Speed	81
Modulation Width	81
Size and Decay	81
Damping	81
Output Filter	81
Early / Late Mix	82
Equalizer	83
Low Shelving	83
Mid Peak / Notch	83
High Shelving	83
Compressor	84
Overview	84
Threshold and Ratio	84

Attack and Release	85
Side Chain High Pass Filter	87
Makeup Gain	87
Gain Reduction Meter	87
Input Gain	87
Dry / Wet	87
Peak Limiter	88
Keyboard	89
Select Keyboard	89
Select Key Range	89
Use Modulation Wheel	89
Use Pitch Wheel	89
Set Velocity	90
Use Key Hold	90
Y-Axis (Per Note Control)	90
Top & Mid Panel	90
Sequencer Play	90
Select Timbre	91
Show Double Keyboard	91
Ribbon Controller	91
Sequencer	92
Clip Editor	93
Load Clip	93
Play/Stop Clip	93
Edit Piano Roll	93
Add edit button	93
Set Loop Mode	93
Auto Select Editor	93
Piano Roll Editor	94
Select Time Range and Loop Length	94

Select Note Range	94
Add Note	94
Delete Note	94
Scale Menu	94
Edit Menu	94
Chromatic Scale	95
Heptatonic Scale	95
Root Key	95
Set Length	96
Quantize	96
Set Velocity	96
Copy	96
Paste	96
Delete	96
Velocity Editor	97
Parameter Automation Editor	98
Play Sequence	99
1. Set host sync	99
2. Set tempo	99
3. Set loop	99
4. Set swing	99
5. Set metronome switch	100
6. Play	100
Record Sequence	100
1. Set recording mode	100
2. Play sequence	100
3. Record notes	100
4. Record parameters automation	100
5. Stop recording	100
Preset	101

File Menu	101
New...	101
Open...	101
Save	101
Preset Browser	102
Load Factory Preset	102
Load User Preset	102
Delete User Preset	102
Save User Preset	102
Backup/Restore User Presets stored in the device	102
Close File Browser	103
CH Preset Browser	103
Open CH Preset Browser	103
Load Factory Preset	103
Close File Browser	103
Setting Panel	104
General	104
Full Screen	104
Open User Guide	104
Open Host Setting	104
Version	104
Color	104
Font	104
CVSEQ Play Override	104
Low Power Mode	104
MIDI Global	105
MIDI Thru	105
MIDI Monitor	105
Musical Typing	105
All Notes Off	105

Map MIDI CC	105
Reset MIDI CC Map	105
Keyboard	105
Split Point	105
MIDI Synth 1 & 2	106
OMNI	106
Input	106
Output	106
MIDI Local	106
MIDI Send	106
MIDI Receive	106
Sustain Pedal	106
Min	106
Max	106
Stand Alone Setting	107
AbletonLink	107
Ableton Link	107
In-app notification	107
Sync Start/Stop	107
Connected Apps	107
Export Audio	108
Save As	108
Location	108
Length (Bars)	108
File Type	108
Sample Rate	108
Bit Depth	108
Export	108
Cancel	108
General	109

Run in Background	109
Resume Headphone Removed	109
Hardware Latency	109
Frame Size	109
MIDI	110
Input	110
Output	110
Bluetooth (BLE) MIDI	111
Central	111
Peripheral	111
Export Audio	112
Prepare for exporting audio	112
1. Stop playback	112
2. Select the first clip to play	112
3. Turn off metronome	112
Adjust export settings	112
1. Save As	112
2. Length	112
3. Location	112
4. File Type	112
5. Sample Rate	112
6. Bit Depth	112
Export Audio File	112
Map MIDI CC	113
MIDI Program Change	113
Use External MIDI Keyboard with Stand Alone	114
Use MIDI Foot Pedal	114
Undo / Redo	115
macOS	116
Menu Bar	116

Application	116
File	116
Edit	117
View	117
Export	117
Window	118
Help	118
Preference	119
Enable Help Section	119
Disable State Recovery	119
Touch Bar (MacBook Pro)	120
1. Play / Stop	120
2. Tempo	120
Use Computer Keyboard as MIDI Keyboard	121
Keyboard Shortcut	122
AUv3 on Apple Garage Band (Mac)	123
Load Plug-in	123
Activate Plug-In	125
Offline Renering	125
Known Limitations	125
AUv3 on Apple Garage Band (iOS)	126
Load Plug-in	126
Change Plug-in Window Size	127
Record Notes	128
Edit Notes	128
Save Project	129
Host Sync	129
System Interruptions (iOS)	130
Specification	131
Release Notes	135

What's new in version 1.0	135
What's new in version 1.0.1	135
What's new in version 1.0.2	135
What's new in version 1.0.3	135
What's new in version 1.0.4	135
What's new in version 1.0.5	135
What's new in version 1.0.6	135

Introduction

Thank you for purchasing VAPolyMk5. To help you get the most out of this product, please read this manual carefully.

VAPolyMk5 is bitimbral polyphonic synthesizer. Main feature of Mk5 is re-designed step sequencer which contains one note sequencer and three modulation sequencers. Oscillator feature hard sync and through zero FM. Low pass Filter is modeled on cascaded OTA -24dB per octave low pass filter circuit.

Each synthesizer consists of three oscillators, resonant low pass and high pass filter, amplifier, three envelope generators, two LFO and key tracking. Two synthesizers can be configured as layer or split. Mk5 also features global LFO, output morphing, classic ring modulator and easy target assignment for mod wheel and aftertouch.

VAPolyMk5 operates as a stand alone or as an AudioUnit Extension (AUv3) for iPhone, iPad and Mac. Stand Alone supports Ableton Link, MIDI and audio file export. Built-in Effects include delay, chorus, flanger, reverb, eq and compressor. Project files can be saved in iCloud Drive, so that the project can be accessed from iPhone, iPad or Mac.

Privacy Settings

VAPolyMk5 uses local area network to connect Ableton Link enable devices and it uses bluetooth to connect with bluetooth MIDI keyboard and controllers. When dialogue appears to confirm use of the local network or the bluetooth, tap OK to give a permission to use them. These settings can be edited in Privacy section of the Setting App.

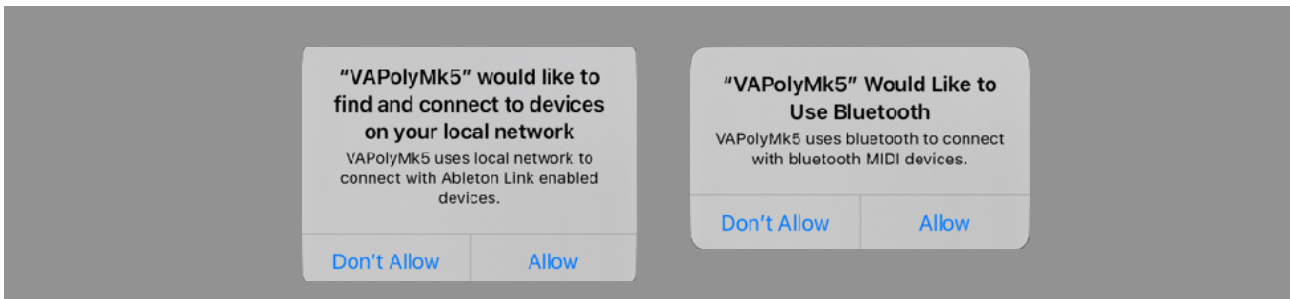

Main Features

- Bitimbral Polyphonic Synthesizer
- Re-designed step sequencer
- Re-designed offset control
- Improved output morphing
- Improved classic ring modulator
- Improved key tracking
- Easy target assignment for mod wheel and aftertouch
- Oscillators feature hard sync and through zero FM
- Low pass Filter is modeled on cascaded OTA -24dB per octave low pass filter circuit.
- Maximum 8 voice polyphony. it depends on performance of the device it is running.
- Built-in effects and piano roll sequencer.
- Audio Export. Linear PCM format (AIFF, WAV and CAF) and compressed format (AAC)
- Support Audio Unit Extension (AUv3).
- Support MIDI 2.0. Support Foot Pedal and Per Note Control.
- Support Ableton Link, Bluetooth MIDI, MIDI In / Out.
- Works on iPhone, iPad and Mac. Support iCloud Drive to share project files between the platforms.

System Requirements

iOS 17.0 or later

macOS 14.0 or later

Devices with Apple Silicon are recommended. A13 Fusion or above is highly recommended.

AudioUnit Extension (AUv3) requires host application which support AudioUnit Extension.

AudioUnit Extension is supported by Apple Logic and Apple Garage Band on iOS and macOS.

For any other DAW, it depends on the application and some of them don't support AudioUnit Extension.

Sound may be distorted if CPU of the device doesn't have enough power. If it happens reduce number of voices or select low power mode in setting panel.

Use as Stand Alone

Stand Alone mode features Audio Export, Ableton Link, MIDI input / output and bluetooth MIDI. Sequencer can be synced with Ableton Link enabled devices and softwares.

Use as AudioUnit Extension (AUv3)

VAPolyMk5 supports AudioUnit Extensions. VAPolyMk5 works with host applications which support AUv3 plug-ins. By enabling host sync mode, VAPolyMk5 can be synced with tempo and transport state of the host application. VAPolyMk5 can send and receive MIDI message to/from the host, if the host supports midi in/out of AUv3.

Factory Preset

Factory presets contains only values of parameters of the synth and the effects. It doesn't contain any sequence data. When loading the preset, it will change the value of the parameters but sequence data remains the same.

User Preset

User Preset contains values of the synth parameters and the sequence data. When loading a user preset, value of the synth parameters and the sequence data are both changed.

User Presets can be saved in iCloud Drive or in AUv3 plug-in. User Presets in iCloud Drive can be accessed from iPhone, iPad or Mac. AUv3 Plug-In Preset is stored on the device and saved preset can be accessed from any host application which support AUv3 User Preset.

State Recovery

When VAPolyMk5 is used as a stand alone, it stores state of the app when the app is terminated. Stored data is recovered when it is launched at the next time. macOS version can disable this feature. The state is stored locally on the device.

About MIDI Latency

Sending or receiving MIDI notes and messages to Software Applications introduces a latency. If you have a problem of latency and DAW or host application has channel delay, adjust the delay time to compensate the latency.

Maximum Number of Touches

Maximum number of touches are varied on devices. Number of notes simultaneously playing on built-in-keyboard are limited to the maximum number of touches.

- * Apple, Mac and GarageBand are trademarks of Apple Inc., registered in the U.S. and other countries.
- * Ableton and Link are trademarks of Ableton AG.
- * All products, companies and standard names are trademarks or registered trademarks of their respective holders.

User Interface



iPad



macOS



Tool Bar

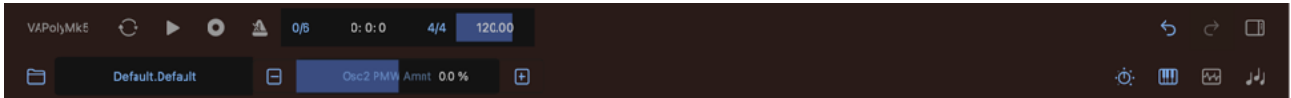

1. Host Sync
Tap this button to enable / disable host sync. When host sync is enabled, tempo and transport is controlled by the host application.
2. Play/Stop
Tap this button to play / stop the sequencer.
3. Record
Tap this button to enable / disable recording mode.
4. Metronome
Tap this button to enable / disable metronome.
5. Swing
Tap this button to show Swing menu.



6. Beat Counter
Indicates current beat time as a format of bar, beat, and sixteenth.
7. Time Signature
Tap this button to show Time Signature menu.



8. Tempo
Adjust BPM (Beat Per Minutes).
9. Undo
10. Redo
Tap the button to undo / redo.
11. Setting Panel
Tap this button to open setting panel.

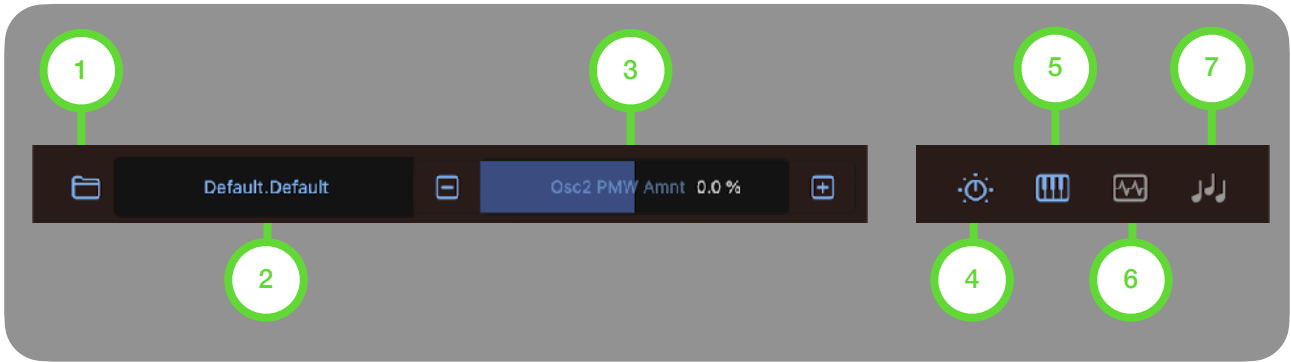

1. File

Tap this button to show file menu.



2. Preset

Indicates name of the selected preset. Tap this button to show preset browser.

3. Parameter

Indicates name and value of the selected parameter. Use plus button, minus button and slider to adjust the value. Double tap to enable menu and tap on the name to show parameter list.

4. Synth

Tap this button to show synth menu.

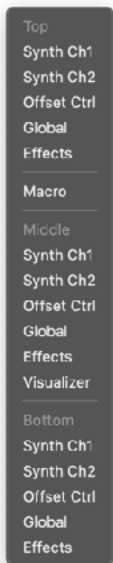

5. Keyboard

Tap this button to show keyboard. Hold this button (right click on macOS) to show keyboard menu.



Mac, iPad

iPhone

6. Visualizer

Tap this button to show audio visualization tool. Hold this button (right click on macOS) to show visualizer menu.

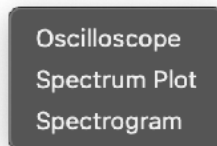

7. Sequencer

Tap this button to show sequencer. Hold this button (right click on macOS) to show sequencer menu.

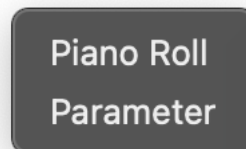

* Content of the menu is dependent on the platform.

Controller

CH Control



1. CH Preset
Indicates name of the selected preset. Tap this button to show ch preset browser.
2. VCO
Tap this tab to open VCO Panel.
3. VCF+VCA
Tap this tab to open VCF+VCA Panel.
4. EG+LFO+EFX
Tap this tab to open EG+LFO+EFX Panel.
5. CV Sequencer
Tap this tab to CV Sequencer Panel.
6. KBD Ctrl
Tap this tab to open KBD Ctrl Panel.
7. Voice Indicator
Indicates active voice.



OSC

1. Transpose
Adjust tuning in semi tones.
2. Detune
Adjust detune amount.
3. Key Sync
Turn on/off oscillator key sync.
4. Unison
Turn it on to enable unison mode.
5. Voice
Adjust number of voices.
6. Pitch bend
Select oscillator to enable pitch bend. Options are All, CH1, CH2, CH3.

14. Fine
Adjust fine tuning in cents.
15. PW
Adjust pulse width for the pulse wave.
16. Shape
Adjust shape of the waveform.
17. Level
Adjust level of the oscillator output.
18. TZFM
Adjust amount of through zero FM.
19. Hard Sync
Turn it on to enable har sync from oscillator 1.
20. ENV EG
Adjust amount of envelope to modulate pitch.

OSC1

7. Tune
Adjust tuning in semi tones.
8. Fine
Adjust fine tuning in cents.
9. PW
Adjust pulse width for the pulse wave.
10. Shape
Adjust shape of the waveform.
11. Level
Adjust level of the oscillator output.

OSC3

22. Tune
Adjust tuning in semi tones.
23. Fine
Adjust fine tuning in cents.
24. PW
Adjust pulse width for the pulse wave.
25. Shape
Adjust shape of the waveform.
26. Level
Adjust level of the oscillator output.
27. TZFM
Adjust amount of through zero FM.

OSC2

13. Tune
Adjust tuning in semi tones.

28. Hard Sync
Turn it on to enable har sync from oscillator 1.
29. ENV EG
Adjust amount of envelope to modulate pitch.

Noise

30. Type

Select pink noise or white noise.

31. Level

Adjust level of noise.



OSC1+

7. FM Amount

Adjust amount of frequency (pitch) modulation.

8. FM LFO

Adjust amount of LFO1/LFO2 for frequency modulation. Turn the dial counter clockwise to increase amount of LFO1. Turn the dial clockwise to increase amount of LFO2.

9. FM EG

Adjust amount of Env1/Env3 for frequency modulation. Turn the dial counter clockwise to increase amount of Env1. Turn the dial clockwise to increase amount of Env3.

10. PWM Amount

Adjust amount of pulse width modulation.

11. PWM LFO

Adjust amount of LFO1/LFO2 for pulse width modulation. Turn the dial counter clockwise to increase amount of LFO1. Turn the dial clockwise to increase amount of LFO2.

12. PWM EG

Adjust amount of Env1/Env3 for pulse width modulation. Turn the dial counter clockwise to increase amount of Env1. Turn the dial clockwise to increase amount of Env3.

OSC2+

13. FM Amount

Adjust amount of frequency (pitch) modulation.

14. FM LFO

Adjust amount of LFO1/LFO2 for frequency modulation. Turn the dial counter clockwise to increase amount of LFO1. Turn the dial clockwise to increase amount of LFO2.

15. FM EG

Adjust amount of Env1/Env3 for frequency modulation. Turn the dial counter clockwise to increase amount of Env1. Turn the dial clockwise to increase amount of Env3.

16. PWM Amount

Adjust amount of pulse width modulation.

17. PWM LFO

Adjust amount of LFO1/LFO2 for pulse width modulation. Turn the dial counter clockwise to increase amount of LFO1. Turn the dial clockwise to increase amount of LFO2.

18. PWM EG

Adjust amount of Env1/Env3 for pulse width modulation. Turn the dial counter clockwise to increase amount of Env1. Turn the dial clockwise to increase amount of Env3.

19. TZFM Amount

Adjust amount of cross modulation from oscillator 1.

20. TZFM LFO

Adjust amount of LFO1/LFO2 for cross modulation. Turn the dial counter clockwise to increase amount of LFO1. Turn the dial clockwise to increase amount of LFO2.

21. TZFM EG

Adjust amount of Env1/Env3 for cross modulation. Turn the dial counter clockwise to increase amount of Env1. Turn the dial clockwise to increase amount of Env3.

OSC3+

22. FM Amount

Adjust amount of frequency (pitch) modulation.

23. FM LFO

Adjust amount of LFO1/LFO2 for frequency modulation. Turn the dial counter clockwise to increase amount of LFO1. Turn the dial clockwise to increase amount of LFO2.

24. FM EG

Adjust amount of Env1/Env3 for frequency modulation. Turn the dial counter clockwise to increase amount of Env1. Turn the dial clockwise to increase amount of Env3.

25. PWM Amount

Adjust amount of pulse width modulation.

26. PWM LFO

Adjust amount of LFO1/LFO2 for pulse width modulation. Turn the dial counter clockwise to increase amount of LFO1. Turn the dial clockwise to increase amount of LFO2.

27. PWM EG

Adjust amount of Env1/Env3 for pulse width modulation. Turn the dial counter clockwise to

increase amount of Env1. Turn the dial clockwise to increase amount of Env3.

28. TZFM Amount

Adjust amount of cross modulation from oscillator 1.

29. TZFM LFO

Adjust amount of LFO1/LFO2 for cross modulation. Turn the dial counter clockwise to increase amount of LFO1. Turn the dial clockwise to increase amount of LFO2.

30. TZFM EG

Adjust amount of Env1/Env3 for cross modulation. Turn the dial counter clockwise to increase amount of Env1. Turn the dial clockwise to increase amount of Env3.



VCF

1. LPF Slope
Select slope of the filter, -12dB Per Octave or -24 dB Per Octave.
2. Gain
Adjust amount of LPF output gain.
3. Link
Turn on to control frequency of LPF and HPF as band pass filter.

LPF

4. Cutoff
Adjust cutoff frequency of the filter.
5. Mod Amount
Adjust amount of cutoff modulation.
6. Key Follow
Adjust amount of key follow. When it is 100%, cutoff frequency is equals to note frequency.
7. Resonance
Adjust amount of resonance.
8. Mod EG
Adjust amount of Env1/Env2 for cutoff modulation. Turn the dial counter clockwise to increase amount of Env1. Turn the dial clockwise to increase amount of Env2.
9. Mod LFO
Adjust amount of LFO1/LFO2 for cutoff modulation. Turn the dial counter clockwise to increase amount of LFO1. Turn the dial clockwise to increase amount of LFO2.

HPF

10. Cutoff
Adjust cutoff frequency of the filter.

11. Mod Amount
Adjust amount of cutoff modulation.

12. Key Follow
Adjust amount of key follow. When it is 100%, cutoff frequency is equals to note frequency.

13. Resonance
Adjust amount of resonance.

14. Mod EG
Adjust amount of Env1/Env2 for cutoff modulation. Turn the dial counter clockwise to increase amount of Env1. Turn the dial clockwise to increase amount of Env2.

15. Mod LFO
Adjust amount of LFO1/LFO2 for cutoff modulation. Turn the dial counter clockwise to increase amount of LFO1. Turn the dial clockwise to increase amount of LFO2.

VCA

16. Volume
Adjust volume of VCA output.

17. Pan
Adjust position of pan or amount of pan modulation.

18. AM
Adjust amount of amplitude modulation.

19. Env
Select an envelope for the amplifier, Gate, Env1 or Env2.

20. Pan LFO
Adjust amount of LFO 1/LFO2 for Pan Modulation. Turn the dial counter clockwise to increase amount of LFO1. Turn the dial clockwise to increase amount of LFO2. When dial is in center position, pan can be adjusted manually.

21. AM LFO

Adjust amount of LFO1/LFO2 for Amplitude Modulation. Turn the dial counter clockwise to increase amount of LFO1. Turn the dial clockwise to increase amount of LFO2.

EG1

22. Attack

Adjust attack time of the envelope.

23. Decay

Adjust decay time of the envelope.

24. Velocity

Adjust amount of velocity to modulate the level of envelope.

25. Sustain

Adjust sustain level of the envelope.

26. Release

Adjust release time of the envelope.

27. Key Follow

Adjust amount of key follow. Duration of each stages is decreased when higher note is played.

EG2

28. Attack

Adjust attack time of the envelope.

29. Decay

Adjust decay time of the envelope.

30. Velocity

Adjust amount of velocity to modulate the level of envelope.

31. Sustain

Adjust sustain level of the envelope.

32. Release

Adjust release time of the envelope.

33. Key Follow

Adjust amount of key follow. Duration of each stages is decreased when higher note is played.



EG

1. EG1 Delay
Adjust delay time to trigger the envelope.
2. EG2 Delay
Adjust delay time to trigger the envelope.
3. EG3 Delay
Adjust delay time to trigger the envelope.

EG3

4. Attack
Adjust attack time of the envelope.
5. Decay
Adjust decay time of the envelope.
6. Velocity
Adjust amount of velocity to modulate the level of envelope.
7. Sustain
Adjust sustain level of the envelope.
8. Release
Adjust release time of the envelope.
9. Key Follow
Adjust amount of key follow. Duration of each stages is decreased when higher note is played.

LFO1

10. Tune
Adjust pitch of the low frequency oscillator.
11. Shape
Select shape of the low frequency oscillator waveform.
12. Delay
Adjust delay time to start the low frequency oscillator.

Adjust delay time to start the low frequency oscillator.

13. Tempo Sync
Turn it on to enable Tempo Sync.
14. Key Sync
Turn it on to enable Key Sync.
15. Env Mod
Select an envelope for Amplitude Modulation, Off, Env1 or Env2.

LFO2

16. Tune
Adjust pitch of the low frequency oscillator.
17. Shape
Select shape of the low frequency oscillator waveform.
18. Delay
Adjust delay time to start the low frequency oscillator.
19. Tempo Sync
Turn it on to enable Tempo Sync.
20. Key Sync
Turn it on to enable Key Sync.
21. Env Mod
Select an envelope modulation, Off, AM by Env1, AM by Env2, FM by ENV1 and FM by Env2.

Key Tracking

22. Break Point (Diagram)
Adjust break point. Diagram display key tracking curve for Env1.
23. Low
Adjust amount of key tracking for low key note.

24. High

Adjust amount of key tracking for high key note.

25. Break Point (Diagram)

Adjust break point. Diagram display key tracking curve for Env2.

26. Level Low

Adjust amount of key tracking for low key note.

27. Level High

Adjust amount of key tracking for high key note.

Effect

28. Delay

Adjust level of Delay send.

29. C/F

Adjust level of Chorus/Flanger send.

30. Reverb

Adjust level of Reverb send.

31. PrePost

Select pre/post of Delay send.

32. PrePost

Select pre/post of Chorus/Flanger send.

33. PrePost

Select pre/post of Reverb send.

<p>“Pre” means pre fader. Signal is taken before volume level is applied to the signal. “Post” means post fader. Signal is taken after volume level is applied to the signal.</p>

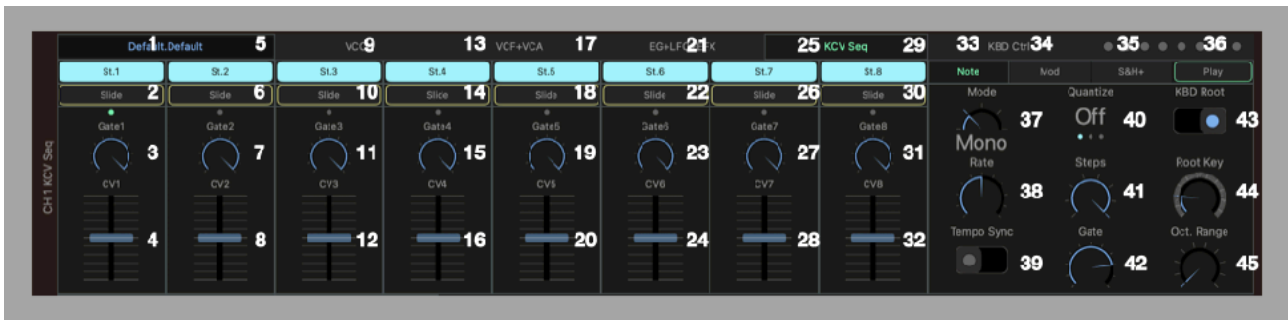

Step Sequencer

1. Step Switch (1 & 5,9,13,17,21,25,29)

Turn it on to enable the step

2. Slide (2 & 6, 10,14,18,22,16,30)

Enable / Disable slide when trigger off.

3. Gate (3 & 7,11,15,19,23,27,31)

Adjust amount of Gate signal (Velocity) for the step.

4. CV (4 & 8,12,16,20,24,28,32)

Adjust Amount of CV signal (Pitch) for the step.

33. Note

Tap this tab to show parameters for Note Sequencer.

34. Mod

Tap this tab to show parameters for Modulation Sequencer.

35. S&H

Tap this tab to show parameters for Sample & Hold.

36. Stop/Play

Turn it on to enable sequencer for playing.
Tap any key on keyboard to start sequencer.

37. Mode

Select operation mode, off, mono, chord or stack. When stack mode is selected, synth1 and synth2 can be played by sequencer of synth1.

38. Rate

Adjust frequency of clock to drive the sequencer.

39. Tempo Sync

Turn it on to enable Tempo Sync.

40. Quantize

Select a quantize option, Off, Minor or Major.

41. Steps

Select number of steps

42. Gate

Adjust pulse width of gate signal.

43. KBD Root

Turn on to set root key by keyboard.

44. Root Key

Select a Root Key.

45. Octave Range

Select an Octave Range



Mod

1. CV1 (1 & 4,7,10,13,16,19,22)
Adjust Amount of CV1 signal for the step.

2. CV2 (2 & 5,8,11,14,17,20,23)
Adjust Amount of CV2 signal for the step.

3. CV3 (3 & 6,9,12,15,18,21,24)
Adjust Amount of CV3 signal for the step.

25. Clock Div 1
Select clock division. Options are 1, 1/2, 1/4 and 1/8.

25. Clock Div 2
Select clock division. Options are 1, 1/2, 1/4 and 1/8.

25. Clock Div 3
Select clock division. Options are 1, 1/2, 1/4 and 1/8.

26. Mod Amount 1
Adjust amount of modulation.

27. Mod Amount 2
Adjust amount of modulation.

28. Mod Amount 3
Adjust amount of modulation.

29. Assign 1
Tap on assign button and tap a control of the same synth to select a modulation target.

30. Assign 2
Tap on assign button and tap a control of the same synth to select a modulation target.

31. Assign 3
Tap on assign button and tap a control of the same synth to select a modulation target.



Sample & Hold

25. Hold 1

Select number of steps to hold the sampled CV. Options are off, 8, 16, 32, 64 and 128.

26. Hold 2

Select number of steps to hold the sampled CV. Options are off, 8, 16, 32, 64 and 128.

27. Hold 3

Select number of steps to hold the sampled CV. Options are off, 8, 16, 32, 64 and 128.

28. Src Mix 1

Adjust balance of LFO1 and Src 2 signal to be sampled.

29. Src Mix 2

Adjust balance of LFO1 and Src 2 signal to be sampled.

30. Src Mix 3

Adjust balance of LFO1 and Src 2 signal to be sampled.

31. Src 2

Select a signal for src 2. Options are LFO (Global) and Noise.

32. Mod Attack

Adjust amount of attack time of modulation signal.

33. Mod Release

Adjust amount of release time for modulation signal.

Default.Default		VCO	VCF+VCA	EG+LF0+EFK	KCV Seq	KBD Ctrl		
Sources 1		Targets 2						
Chase Ctrl	Mod Wheel	CSC1 Pitch	OSC1 PW	DSC2 Pitch	OSC2 PW	OSC2 Xmod	OSC3 Pitch	OSC3 PW
	Velocity							
	Aftertouch	OSC3 Xmod	LPF CF	HPF CF	VCA Level	VCA Fan	VCO Pitch	VCO PW
	Poly Pressure							
	Expression	VCO Xmod	Mixer Level	Vibrato Depth	Tremolo Depth	Reverb Send	Chorus Send	Delay Send
Per Note Ctrl								

KBD Control Routing

1. Control Sources

Select Keyboard Controller.

2. Control Targets

Select target parameters to control.



Offset Control

1. CH

Select a target of offset control. Options are CH1&CH2, CH1 and CH2.

2. Pitch

Select pitch range of control. Options are coarse and fine.

3. Mod

Turn on to control modulation amount except Env1 and Env2.

4. OSC1 Pitch

Adjust offset of OSC1 pitch.

5. OSC1 Shape

Adjust offset of OSC1 shape.

6. OSC1 PW

Adjust offset of OSC1 pulse width.

7. OSC2 Pitch

Adjust offset of OSC2 pitch.

8. OSC2 Shape

Adjust offset of OSC2 shape.

9. OSC2 PW

Adjust offset of OSC2 pulse width.

10. OSC3 Pitch

Adjust offset of OSC3 pitch.

11. OSC3 Shape

Adjust offset of OSC3 shape.

12. OSC3 PW

Adjust offset of OSC3 pulse width.

13. OSC1 Level

Adjust offset of OSC1 level.

14. OSC2 Level

Adjust offset of OSC2 level.

15. OSC3 Level

Adjust offset of OSC3 level.

16. LPF Cutoff

Adjust offset of LPF cutoff.

17. LPF Reso

Adjust offset of LPF resonance.

18. LPF Mod

Adjust offset of LPF Modulation amount.

19. HPF Cutoff

Adjust offset of HPF cutoff.

20. HPF Reso

Adjust offset of HPF resonance.

21. HPF Mod

Adjust offset of HPF Modulation amount.

22. VCA Level

Adjust offset of VCA level.

23. VCA Pan

Adjust offset of VCA pan amount.

24. VCA AM

Adjust offset of VCA amplitude modulation amount.

25. EFX Delay

Adjust offset of delay send amount.

26. EFX C/F

Adjust offset of chorus/flanger send amount.

27. EFX Reverb

Adjust offset of reverb send amount.

28. ENV1 Attack

Adjust offset of ENV1 attack amount.

29. ENV1 Sustain

Adjust offset of ENV1 sustain amount.

30. ENV1 Release

Adjust offset of ENV1 decay/release amount.

31. ENV2 Attack

Adjust offset of ENV2 attack amount.

32. ENV2 Sustain

Adjust offset of ENV2 sustain amount.

33. ENV2 Release

Adjust offset of ENV2 decay/release amount.



Global Control

1. **Glide Time**
Adjust glide (portamento) time.
2. **FM Type**
Select a FM type. Options are Portamento and Glissando.
3. **FM Range**
Select a range of FM. Options are 1 octave, 2 octave and 4 octave.

ARP

4. **Pattern**
Select a pattern of arpeggio.
5. **Rate**
Adjust rate of arpeggio.
6. **Gate**
Adjust pulse width of gate signal.
7. **Off/On**
Turn on/off arpeggio.
8. **Tempo Sync**
Turn on/off tempo sync.
9. **CH**
Select a target of ARP. Options are CH1&2, CH1 and CH2.

Aftertouch

10. **Vibrato**
Adjust amount of vibrato to be controlled by aftertouch.
11. **Tremolo**
Adjust amount of tremolo to be controlled by aftertouch.
12. **LFO**

Adjust amount of LFO target to be controlled by aftertouch.

Mod Wheel

13. **Vibrato**
Adjust amount of vibrato to be controlled by mod wheel.
14. **Tremolo**
Adjust amount of tremolo to be controlled by mod wheel.
15. **LFO**
Adjust amount of LFO target to be controlled by mod wheel.

LFO

16. **Tune**
Adjust frequency of the low frequency oscillator.
17. **Shape**
Select shape of the low frequency oscillator waveform.
18. **Delay**
Adjust delay time to start the low frequency oscillator.
19. **Tempo Sync**
Turn it on to enable Tempo Sync.
20. **KeySync**
Turn it on to enable Key Sync.
21. **CH**
Select a target of LFO modulation. Options are CH1&2, CH1 and CH2.
22. **FM Amount**
Adjust amount to modulate pitch of oscillators.

23. CF Amount
Adjust amount to modulate cutoff of LPF.

24. PAN Amount
Adjust amount to modulate VCA pan.

Ring Mod

25. Attack
Adjust attack time of envelope to modulate speed of Modulator.

26. Decay
Adjust decay time of envelope to modulate speed of Modulator.

27. Depth
Adjust amount of envelope to modulate speed of Modulator.

28. Speed

Adjust speed (Frequency) of Modulator.

29. Mod Amount
Adjust amount of modulation by Modulator.

30. CH
Select a target of ring modulation. Options are CH1&2, CH1 and CH2.

Morph

31. Stereo
Adjust stereo position of output from CH1 & 2.

32. Mix
Adjust balance of output from CH1 & 2.

33. LFO
Adjust amount of LFO to modulate balance of mix.



Delay

1. Delay Time
Adjust delay time.
 2. LFO Frequency
Adjust frequency of LFO (low frequency oscillator).
 3. HP Frequency
Adjust frequency of high pass filter for the delayed sound.
 4. Feedback
Adjust amount of the feedback.
 5. LFO intensity
Adjust amount of LFO delay time modulation.
 6. LP Frequency
Adjust frequency of low pass filter for the delayed sound.
- Sync Switch Tab
Turn it on to enable tempo sync.

Chorus / Flanger

7. LFO Frequency
Adjust frequency of the LFO.
 8. LFO intensity
Adjust amount of LFO for delay time modulation.
 9. Delay Time
Adjust delay time.
 10. Chorus/Flanger
Select Chorus or Flanger.
 11. Feedback
Adjust amount of the feedback.
 12. Stereo Width
Adjust stereo width.
- Sync Switch Tab

Turn it on to enable tempo sync.

Reverb

13. Room Size
Adjust room size of the late reflection.
 14. Decay
Adjust decay of the late reflection.
 15. Damping
Adjust absorption of high frequency in the late reflection.
 16. Auto Size
Turn it on to enable auto size mode.
 17. Pre Delay
Adjust pre delay time of the early reflection.
 18. Output LP Frequency
Adjust frequency of output low pass filter.
- Sync Switch Tab
Turn it on to enable tempo sync.

EQ and Mixer

19. High Frequency
Adjust frequency of high shelving filter.
20. Mid Frequency
Adjust frequency of mid peak / notch filter.
21. Low Frequency
Adjust frequency of low shelving filter.
22. High Gain
Adjust gain of the high shelving filter.
23. Mid Gain
Adjust gain of the mid peak / notch filter.
24. Low Gain
Adjust gain of the low shelving filter.

Compressor

25. Reduction Gain Meter

Indicate amount of gain reduction.

26. Attack

Adjust time to start compression.

27. Threshold

Adjust level of threshold to begin compression.

29. Release

Adjust time to end compression.

30. Makeup

Adjust amount of makeup gain.

Master Output

31. Volume

Adjust amount of master volume.

32. Pan

Adjust amount of master pan.

33. Mute

Turn it on to mute output signal.



Chorus / Flanger

7. Sine/Triangle

Adjust shape of the LFO waveform, Sine or Triangle.

8. HP Frequency

Adjust frequency of high pass filter for the effected sound.

9. LP Frequency

Adjust frequency of high pass filter for the effected sound.

Reverb

13. HP Frequency

Adjust frequency of input high pass filter.

14. LFO Frequency

Adjust frequency of LFO (Low Frequency Oscillator).

15. Early/Late

Adjust amount of the early reflection and amount of the late reflection.

16. LP Frequency

Adjust frequency of input low pass filter.

17. LFO intensity

Adjust amount of LFO for delay time modulation.

18. EFX Input

Adjust amount of input signal from Delay and Chorus/Flanger.

Mixer

19. Delay Level

Adjust level of Delay.

20. C/F Level

Adjust level of Chorus / Flanger.

21. Reverb Level

Adjust level of Reverb.

Compressor

26. Input Gain

Adjust amount of input gain.

27. HP Frequency

Adjust frequency of high pass filter at the input of the compressor.

29. Ratio

Adjust compression ratio.

30. Dry/Wet

Adjust amount of the dry and wet signal.



A. Delay Sync Switch Tab

Turn it on to enable tempo sync.

B. C/F Sync Switch Tab

Turn it on to enable tempo sync.

C. Reverb Sync Switch Tab

Turn it on to enable tempo sync.

1. Delay: Delay Time

Adjust delay time in note length.

7. C/F: LFO Frequency

Adjust frequency in note length.

13. Reverb: Room Size

Adjust room size in note length.

14. Reverb: LFO Frequency

Adjust frequency in note length.

Keyboard

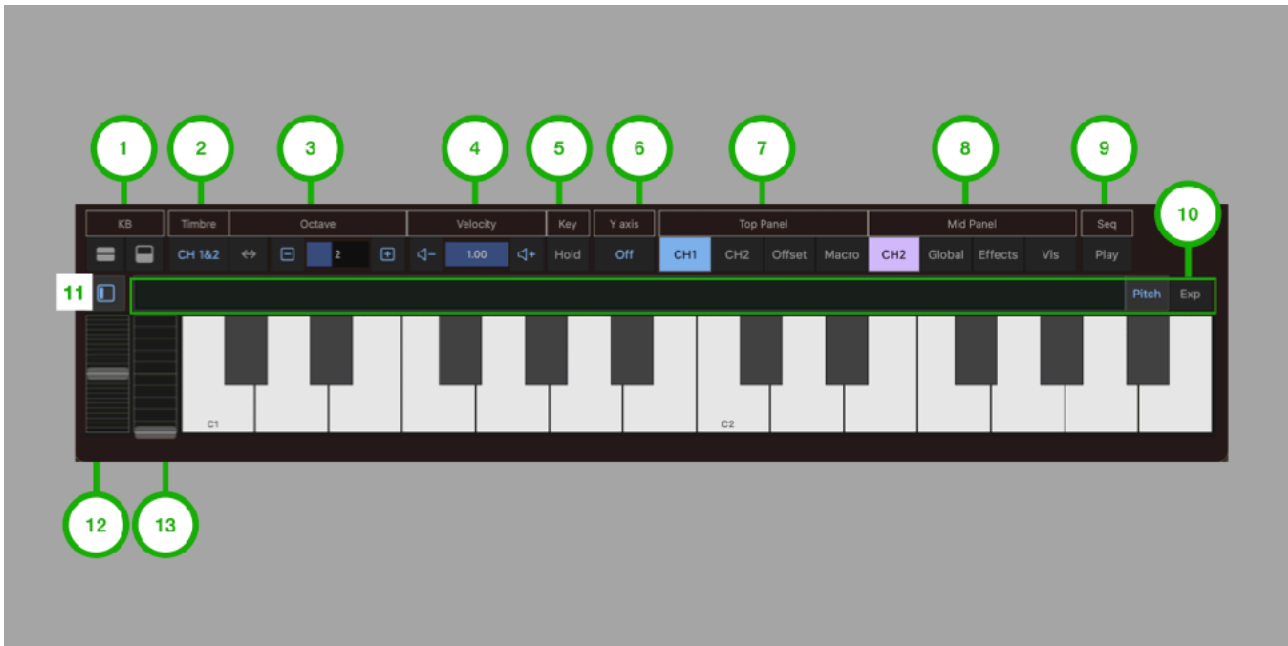

1. Split & Target

Tap this button to show split keyboard. Tap target button to select a target of control.

2. Timbre Menu

Select a timbre for the keyboard to play.

3. Octave Range

Use plus / minus buttons to adjust octave range of the keyboard. Indicator shows lowest note of the keyboard¹. When “Midi Monitor” is enabled, the range is automatically set based on the incoming midi note. Tap on arrow button to enable/disable keyboard scrolling.

4. Velocity

Use plus/minus button to adjust keyboard velocity.

5. Hold

Tap this button to enable /disable key holding.

6. Y-Axis (Per Note Control Targets)

Select targets of Per Note Control. Apply the control by movement on Y axis of Key. Options are pressure, pitch and control.

7. Top Panel

Select a content of top panel.

8. Mid Panel

Select a content of mid panel.

9. Sequencer Play

Turn it on to enable sequencer for playing. Tap any key on keyboard to start sequencer.

10. Ribbon Controller

Drag on the Ribbon to control Pitch or Expression. Targets of the ribbon control can be selected by pitch and expression buttons on the left. Targets of the expression can be selected in KBD Control Routing Panel.

11. Wheel View Switch

Tap this button to show/hide pitch wheel and mod wheel.

12. Pitch Wheel

Adjust pitch of the oscillators. Range is plus / minus one octave.

13. Mod Wheel

Adjust amount of the modulation. Targets of the modulation can be selected in KBD Control Routing Panel.

¹ Middle C (midi note 60) is C3.

Visualizer

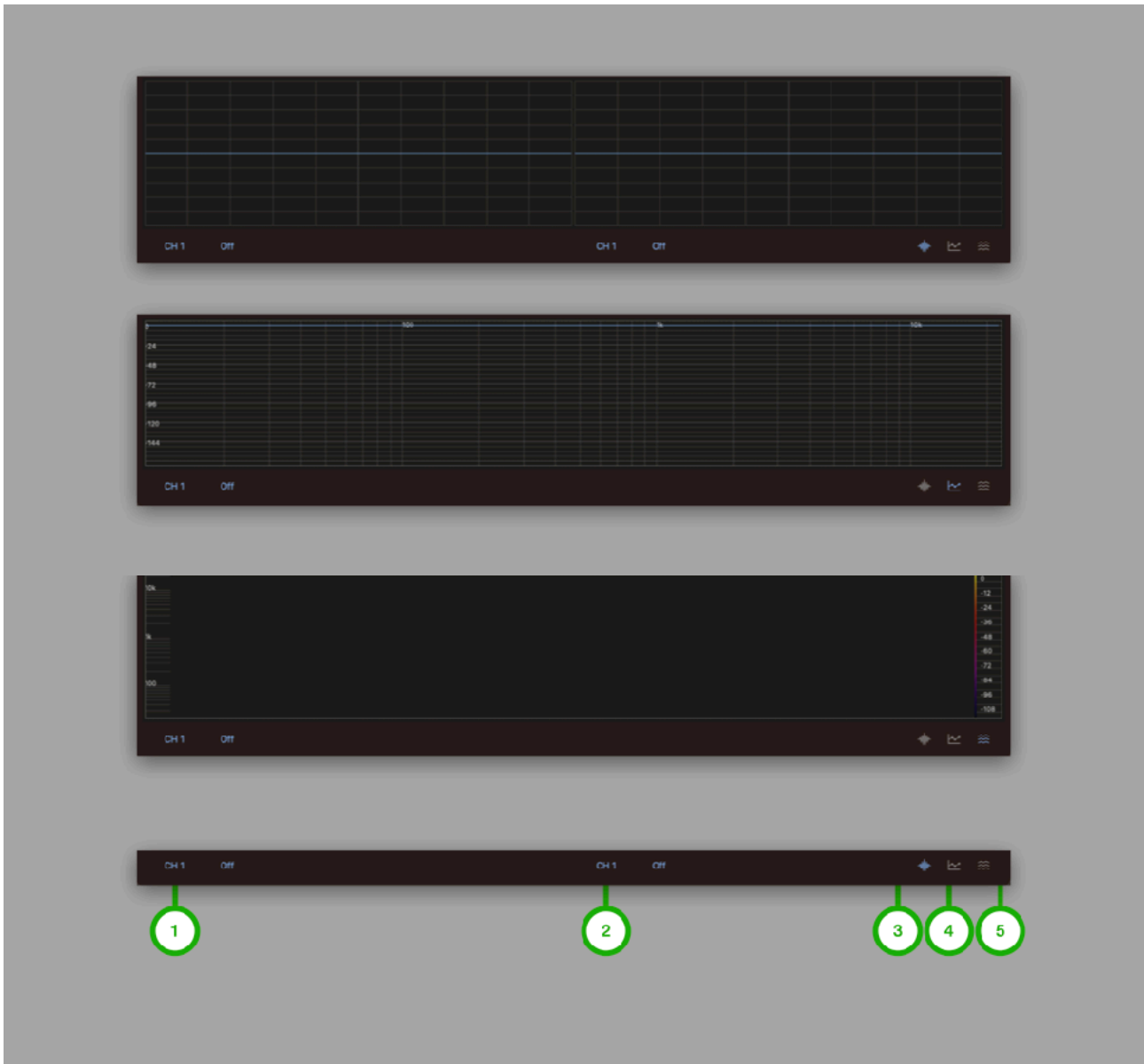

1. Timbre Selector

Tap this button to show a list and select a timbre of audio source.

2. Audio Source Selector

Tap this button to show a list. Select audio source for the visualization.

3. Timbre Selector

Tap this button to show a list and select a timbre of audio source.

4. Audio Source Selector

Tap this button to show a list. Select audio source for the visualization.

5. Oscilloscope Button

Tap this button to select Oscilloscope.

6. Spectrum Plot Button

Tap this button to select Spectrum Plot.

7. Spectrogram Button

Tap this button to select Spectrogram.

Tap and hold (right click on macOS) to show context menu.

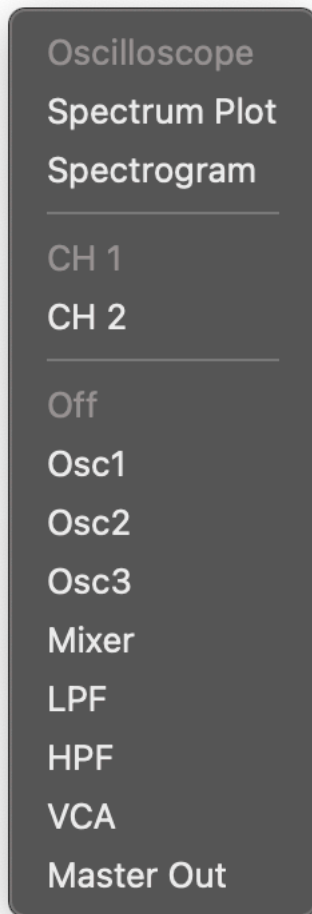

Select a tool for audio visualization. Options are Oscilloscope, Spectrum Plot and Spectrogram.

Select a timbre of audio source.

Select a source of audio for the visualization.

Sequencer

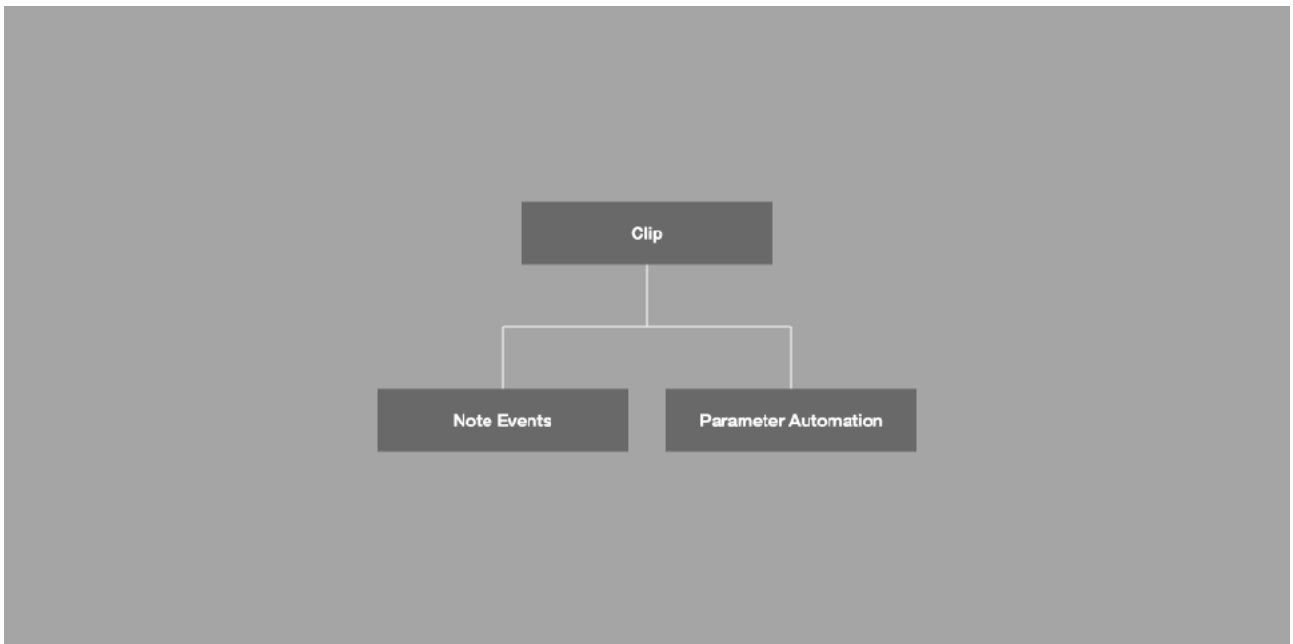
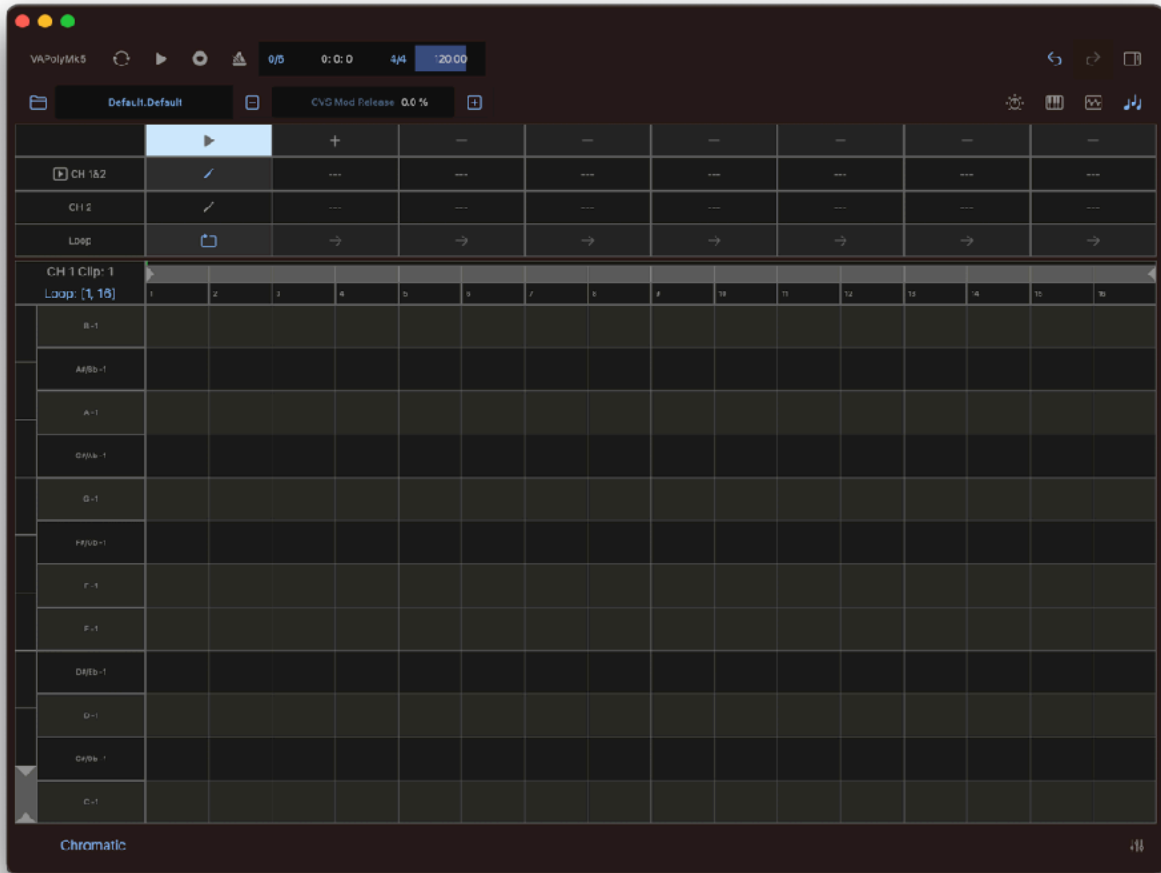

Clip contains note events and parameter automation events for each timbral. Maximum length of clip is 16 bars. Maximum number of clips are 8.

Clip Editor

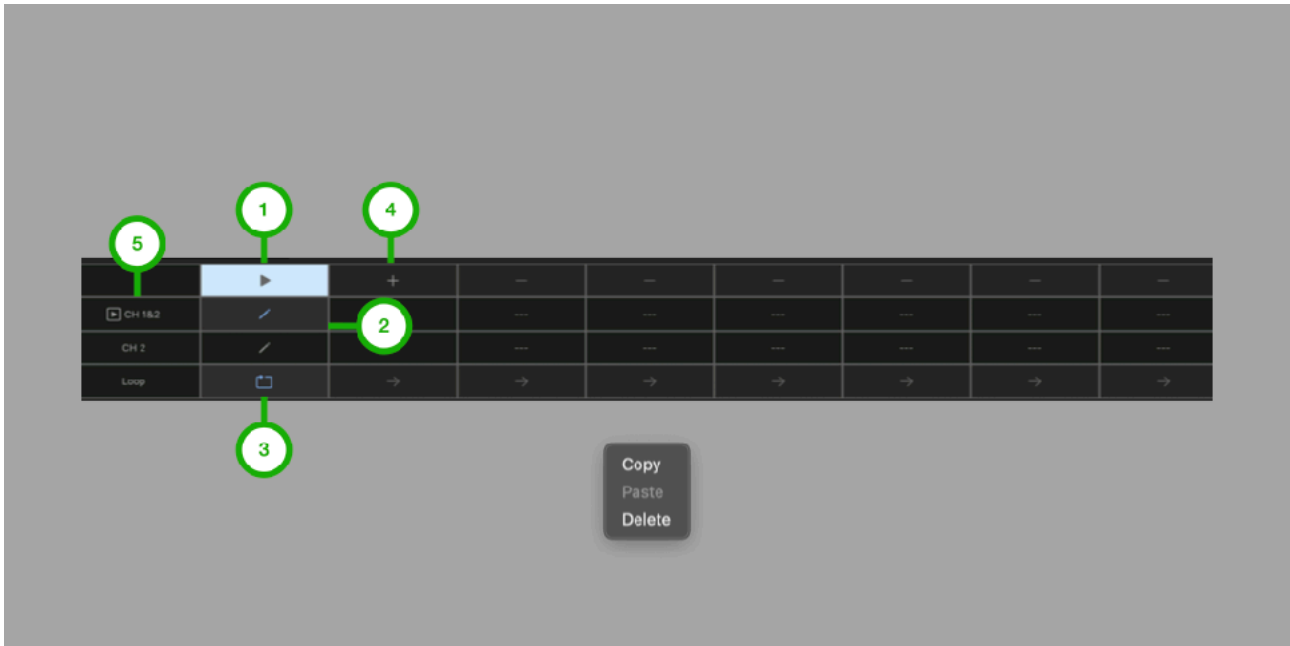

1. Launch Button

Tap this button to play/stop clip.

2. Edit Button

Tap this button to open piano roll editor.

3. Loop Selector

Select loop options.

4. Add Button

Tap this button to add edit button.

5. Auto Select Button

Enable/Disable Auto Select to select editor while sequencer is playing.

Piano Roll Editor

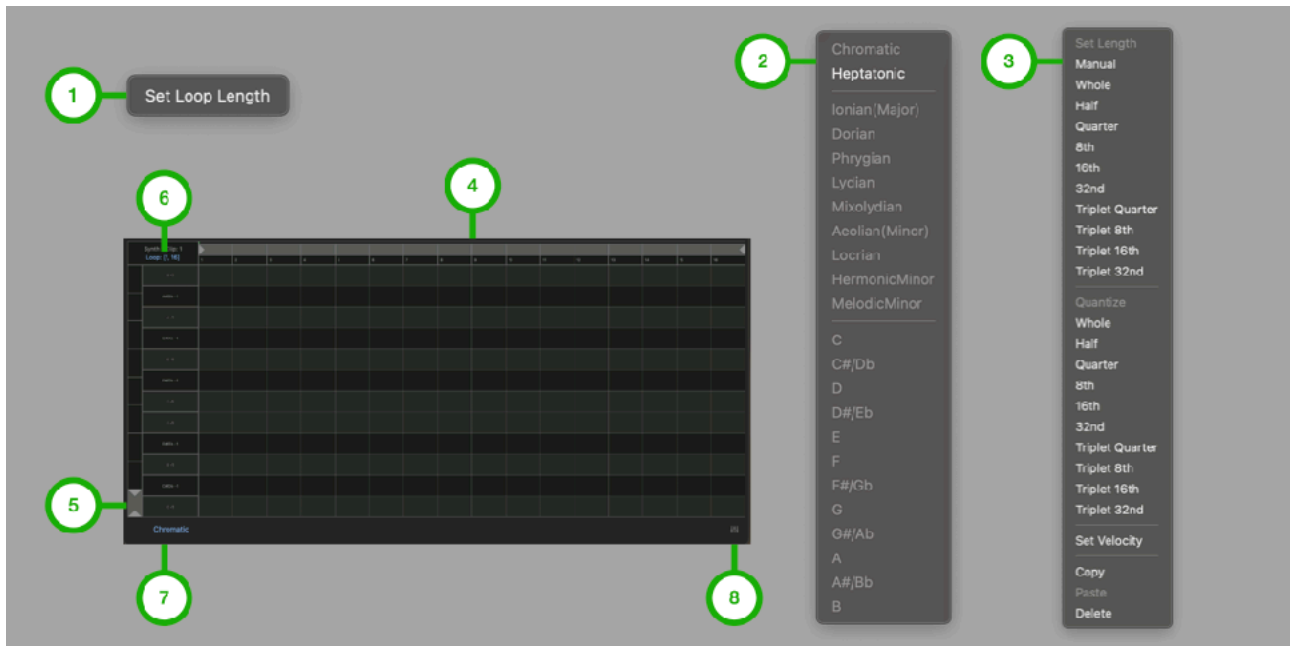

1. Loop Menu

Press and hold (right click on macOS) Time Range Selector to show this menu. Tap on “Set Loop Length” to set loop length to current length selected by the Time Range Selector.

2. Scale Menu

Press and hold (right click on macOS) editor to show this menu.

3. Editing Menu

Press and hold (right click on macOS) note to show this menu.

4. Time Range Selector

Select time range for editing and for loop length. On iOS, pinch gesture control zooming and drag gesture control scroll position.

5. Note Range Selector

Select note range for editing. On iOS, pinch gesture control zooming and drag gesture control scroll position.

6. Loop Range

Tap this button to show Loop Menu.

7. Scale

Tap this button to show Scale Menu

8. Parameter Automation Button

Tap this button to show Parameter Automation Editor

Parameter Automation Editor

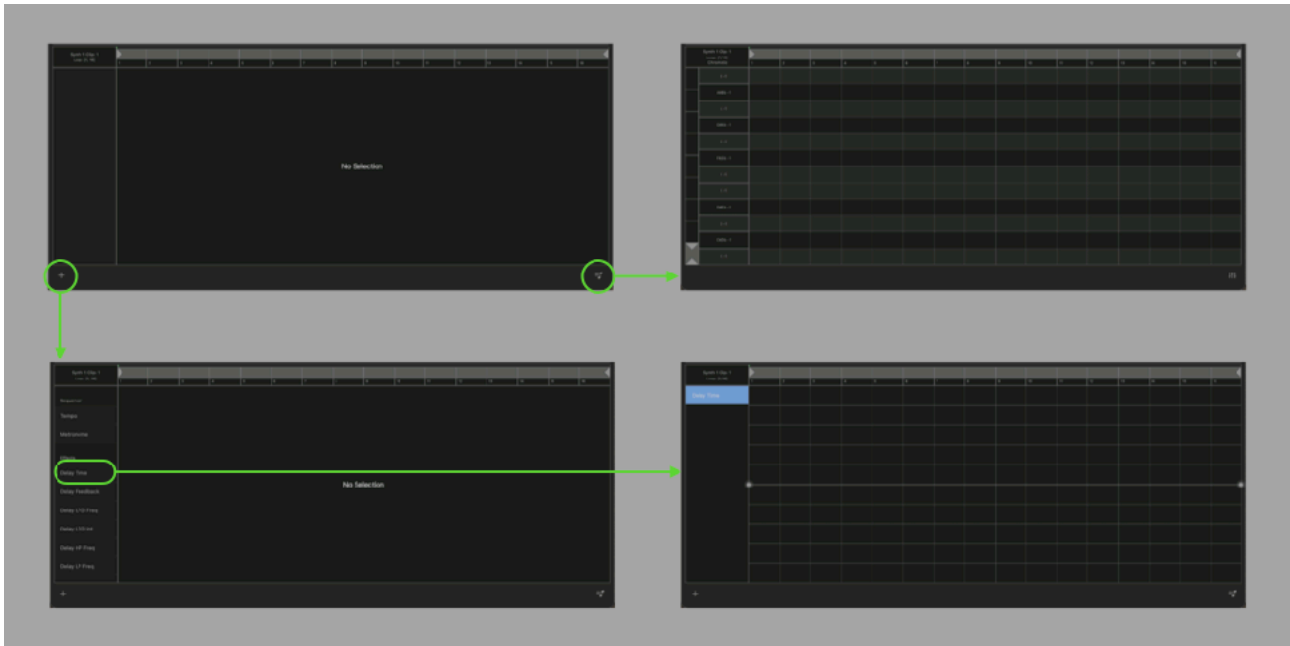

1. Loop Menu

Press and hold (right click on macOS) Time Range Selector to show this menu. Tap on “Set Loop Length” to set loop length to current length selected by the Time Range Selector.

2. List Menu

Press and hold (right click on macOS) item in parameter list to show this menu.

3. Editing Menu

Press and hold (right click on macOS) editor to show this menu.

4. Time Range Selector

Select time range for editing and for loop length.

5. Add Button

Tap this button to select parameter to edit.

6. Piano Roll Button

Tap this button to show piano roll editor.

Synthesizer

VAPolyMk5 is bitimbral polyphonic synthesizer. Each Voice of the synthesizer consists of oscillator1, oscillator2, oscillator3, mixer, resonant low pass filter, resonant high pass filter, amplifier, three envelope generators and LFO. Synthesizer 1&2 can be configured as layer or split. Output of the synthesizer is routed to effects, mixer, EQ, compressor and main output amplifier.

Block diagram

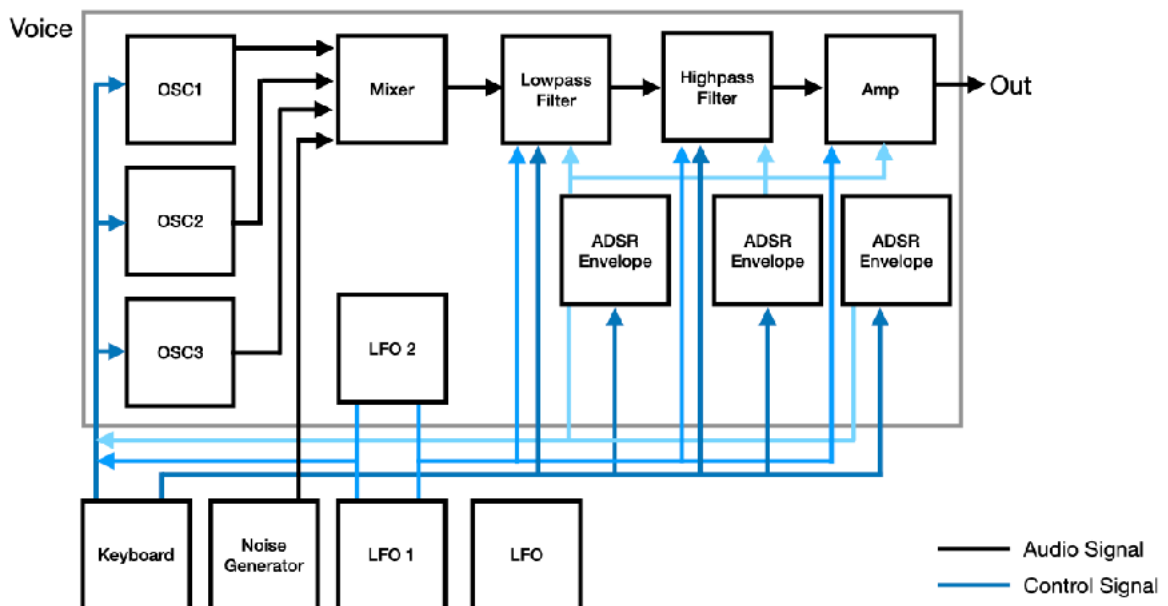
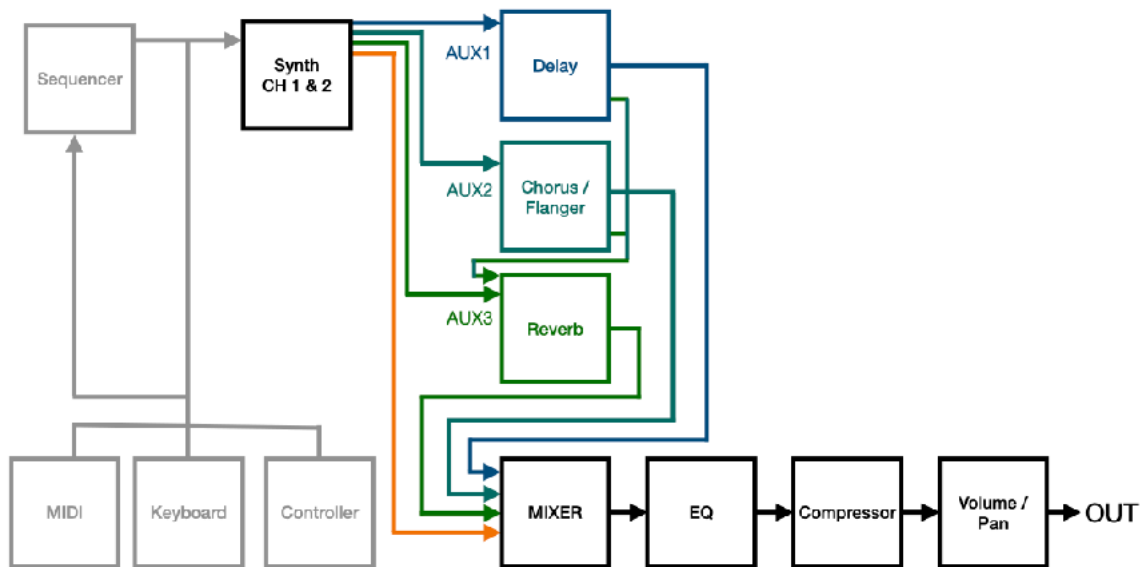

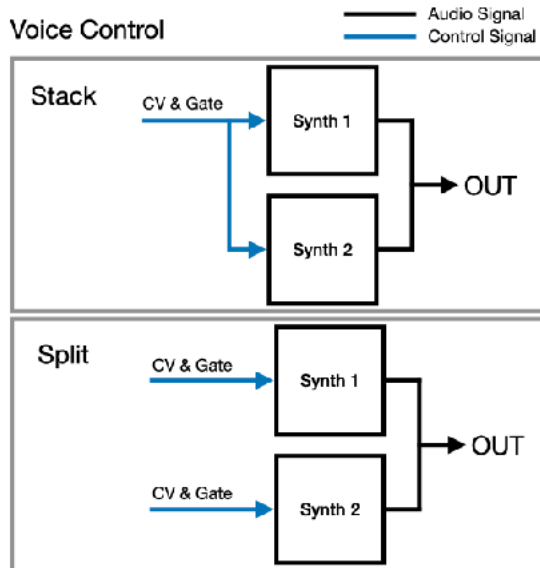

Oscillator Hard Sync & Cross Modulation

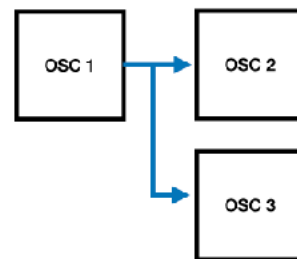

Control Signal & MIDI Flow

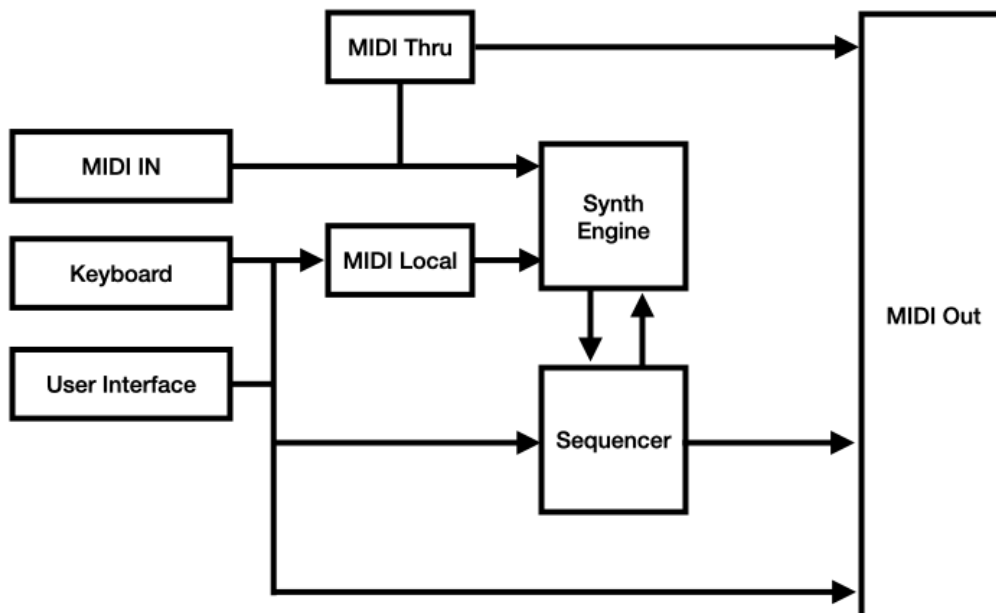

Oscillators

Oscillator 1, 2 & 3 features continuously variable waveform oscillator. Yellow LED in modulation tab indicates when parameters are modulated.



Tune

Adjust pitch of the oscillator. (maximum +/- 24 semitones)

Fine

Adjust pitch of the oscillator. (+/- 50 cents)
Use Fine Tune to detuning the oscillator relative to the other oscillators.

PW (Pulse Width)

Adjust pulse width of the square (pulse) wave. When Square wave is selected, pulse width of 0% and 100% produce DC signal² resulting no audible output.

Shape

Adjust shape of the waveform. Fully counter clockwise position is Sine, center is Saw, and fully clockwise position is Square.

Level

Adjust output level of oscillator in dB scale from -60 dB to 0 dB.

TZFM Amount

Adjust amount of cross modulation. Use TZFM amount of modulation section to adjust amount of envelope and LFO for cross modulation. (maximum +/- 4 octaves)

Hard Sync

Turn this switch on to sync OSC2 or OSC3 to OSC1. (OSC1 is a master.) It forces OSC2 or OSC3 to follow frequency of the OSC1 in “hard” synchronization. Adjusting Tune of OSC2 or OSC3 produces unusual wave shapes resulting unusual timbre. Typical use of Sync is modulate frequency of OSC2 or OSC3 by envelope. It will produce classic Hard Sync Sound. When OSC2 or OSC3 waveform is Square and Tune of OSC2 or OSC3 is lower than OSC1, it produces DC signal resulting no audible output.

FM EG

Adjust amount of Env1/Env3 signal for frequency modulation. Turn the dial counter clockwise to increase amount of Env1. Turn the dial clockwise to increase amount of Env3. When Hard Sync is on, this control can modulate pitch of oscillator. When Hard Sync is off, amount of this control is adjusted by FM Amount in modulation section. (maximum +/- 4 octave)

² DC Signal is always positive or always negative and produce no sound.



FM Amount

Adjust amount of exponential frequency modulation. Range of frequency modulation can be adjusted by FM Range control in global panel. (maximum +/- 4 octave)

FM LFO

Adjust amount of LFO1/LFO2 signal for frequency modulation. Turn the dial counter clockwise to increase amount of LFO1. Turn the dial clockwise to increase amount of LFO2.

FM EG

Adjust amount of Env1/Env3 signal for frequency modulation. Turn the dial counter clockwise to increase amount of Env1. Turn the dial clockwise to increase amount of Env3.

PWM Amount

Adjust amount of pulse width modulation.

PWM LFO

Adjust amount of LFO1/LFO2 signal for pulse width modulation. Turn the dial counter clockwise to increase amount of LFO1. Turn

the dial clockwise to increase amount of LFO2.

PWM EG

Adjust amount of Env1/Env3 signal for pulse width modulation. Turn the dial counter clockwise to increase amount of Env1. Turn the dial clockwise to increase amount of Env3.

TZFM Amount

Adjust amount of envelope and LFO to modulate amount of modulation signal from OSC1 for cross modulation. (maximum +/- 4 octave)

TZFM LFO

Adjust amount of LFO1/LFO2 signal for cross modulation. Turn the dial counter clockwise to increase amount of LFO1. Turn the dial clockwise to increase amount of LFO2.

TZFM EG

Adjust amount of Env1/Env3 signal for cross modulation. Turn the dial counter clockwise to increase amount of Env1. Turn the dial clockwise to increase amount of Env3.



Transpose

Adjust amount of transpose (+/- 24 semi tones).

Detune

Adjust amount of detune (+1 cent).



Key Sync

Enable/disable key Sync. When it is turned on, oscillator reset each time key is pressed.

Unison

Turn this switch on to enable unison mode. When Unison mode is enabled, specified number of voices are stacked to generate monophonic sound.

Voices

Select maximum number of voices. When using a device with less powerful CPU, it may need to reduce maximum number of voices.

Pitch Bend

Select targets of pitch bend. Options are All, OSC1, OSC2 and OSC3.

Noise Type

Select type of noise. Options are Pink Noise and White Noise.

Level

Adjust output level of Ring Modulator, Sub Oscillator and Noise Generator in dB scale from -60 dB to 0 dB.

Low Pass Filter

This low pass filter is modeled on the cascaded OTA -24dB per octave low pass filter circuit. The filter is capable of self oscillation when resonance is at the maximum position. Cutoff frequency of the low pass filter can be modulated by an ADSR envelope and a LFO. Also the cutoff frequency can be controlled by keyboard with the amount adjusted by key follow parameter.



Cutoff

Adjusts the cutoff frequency of the filter.

Resonance

Adjusts resonance of the filter.

Mod Amount

Adjust amount of cutoff frequency modulation.

Mod EG

Adjust amount of ENV1/ ENV2 signal for cutoff modulation. Turn the dial counter clockwise to increase amount of ENV1. Turn the dial clockwise to increase amount of ENV2.

Mod LFO

Adjust amount of LFO1/LFO2 signal for cutoff modulation. Turn the dial counter clockwise to increase amount of LFO1. Turn the dial clockwise to increase amount of LFO2.

Key Follow

Adjust amount of key follow. When it is 100%, cutoff frequency is equals to keyboard note frequency.

LPF Slope

Select slope of the filter, -12dB Per Octave or -24 dB Per Octave.

Gain

Adjust amount of LPF output gain.

Link

Turn on to enable cutoff of LPF and HPF to adjust frequency of the both filter as band pass filter. Cutoff of LPF adjust base frequency and cutoff of HPF adjust width of the band.

High Pass Filter

This high pass filter is modeled on the Sallen-Key -12dB per octave high pass filter circuit. The filter is capable of self oscillation when resonance is at the maximum position. Cutoff frequency of the high pass filter can be modulated by an ADSR envelope and a LFO. Also the cutoff frequency can be controlled by keyboard with the amount adjusted by key follow parameter.



Cutoff

Adjusts the cutoff frequency of the filter.

Resonance

Adjusts resonance of the filter.

Mod Amount

Adjust amount of cutoff frequency modulation.

Mod EG

Adjust amount of ENV1/ ENV2 signal for cutoff modulation. Turn the dial counter clockwise to

increase amount of ENV1. Turn the dial clockwise to increase amount of ENV2.

Mod LFO

Adjust amount of LFO1/LFO2 signal for cutoff modulation. Turn the dial counter clockwise to increase amount of LFO1. Turn the dial clockwise to increase amount of LFO2.

Key Follow

Adjust amount of key follow. When it is 100%, cutoff frequency is equals to keyboard note frequency.

VCA (Amplifier)

The output signal of the filter is routed to the amplifier. The signal is shaped by gate signal or ADSR envelope. The audio signal can be modulated by LFO. The output level can be adjusted by volume parameter.



Volume

Adjust volume of Output Signal.

PAN

Adjust amount of pan modulation.

AM

Adjust amount of amplitude modulation.

Env

Select an envelope for the amplifier, Gate, Env1 or Env2.

Pan LFO

Adjust amount of LFO signal for Pan Modulation. Turn the dial counter clockwise to increase amount of LFO1. Turn the dial clockwise to increase amount of LFO2. When dial is in center position, pan can be adjusted manually.

AM LFO

Adjust amount of LFO signal for Amplitude Modulation. Turn the dial counter clockwise to increase amount of LFO1. Turn the dial clockwise to increase amount of LFO2.

ADSR (Envelope Generator)

ADSR is an analog style non-linear envelope generator.



Attack

Adjust the attack time of the ADSR envelope (from 1 ms to 6 sec)

Decay

Adjust the decay time of the ADSR envelope (from 1 ms to 10 sec)

Sustain

Adjust sustain amount of the ADSR envelope (from 0% to 100%)

Release

Adjust release time of the ADSR envelope (from 1 ms to 10 sec)

Velocity

Adjust amount that Keyboard velocity affect level of envelope.

Key Follow

Adjust amount that CV affect length of envelope.

Delay

Adjust delay time to trigger the ADSR envelope (from 0 ms to 10 sec)

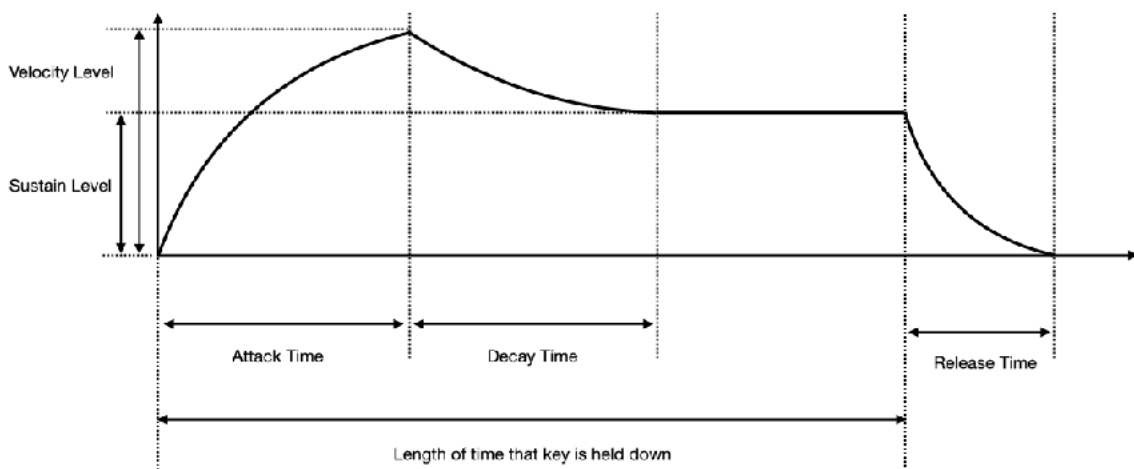

LFO

LFO (Low Frequency Oscillator) can generate 6 wave shapes and the frequency of the LFO can be set by Hz or note value when LFO is synchronized to tempo. Amplitude of the LFO can be modulated by ADSR envelope. LFO1 is common for all voices. LFO2 is polyphonic.



Tune

Adjust frequency of the LFO. When sync is off, range of the frequency is from 0.04Hz to 42.2Hz. When sync is on, range of the rate is from 1/64 to 8 bars.

Shape

Select shape of the LFO waveform. Wave shapes are sine, saw, down saw, square, triangle and random.

Delay

Adjust delay time to start the LFO signal.

Tempo Sync

Turn this switch on to sync the rate of the LFO with tempo.

Key Sync (Key Re-Trigger)

Turn this switch on to restart the LFO cycle every time a new note is played.

Env Mod

Select an envelope to modulate amplitude of LFO. Options are OFF, Env1 and Env2.

Env Mod (LFO2)

Select an envelope modulation. Options are off, AM Env1, AM Env2, FM Env1 and FM Env2.

Key Tracking

Key Tracking to adjust level of envelope output based on a frequency of note pressed on keyboard.

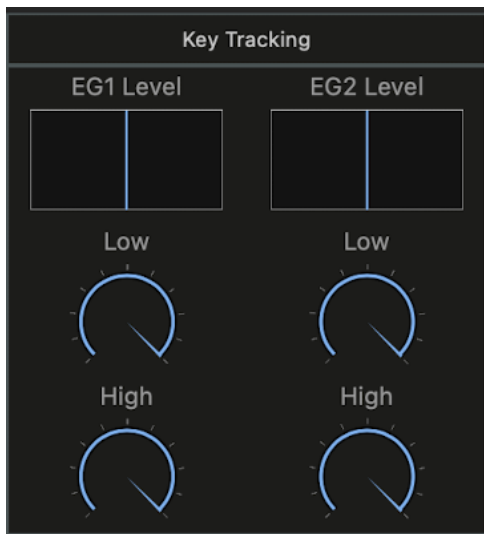

EG1 Break Point

Adjust break point.

EG1 Low

Adjust amount of eg1 when low key is pressed.

EG1 High

Adjust amount of eg1 when high key is pressed.

EG2 Break Point

Adjust break point.

EG2 Low

Adjust amount of eg2 when low key is pressed.

EG2 High

Adjust amount of eg2 when high key is pressed.

EFX Send

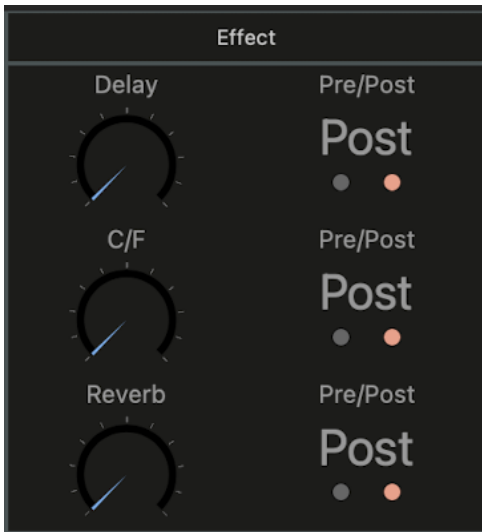

Delay Send

Adjust level of the signal send to delay effect.

C/F Send

Adjust level of the signal send to chorus / flanger effect.

Reverb Send

Adjust level of the signal send to reverb effect.

Delay Pre/Post

Select Pre (pre fader) or post (post fader) to specify source of the signal for delay.

C/F Pre/Post

Select Pre (pre fader) or post (post fader) to specify source of the signal for chorus/flanger.

Reverb Pre/Post

Select Pre (pre fader) or post (post fader) to specify source of the signal for reverb.

<p>“Pre” means pre fader. Signal is taken before volume level is applied to the signal. “Post” means post fader. Signal is taken after volume level is applied to the signal.</p>

Output Mixer

Output Signals from the effects can be adjusted by output mixer.



Delay Level

Adjust level of delay signal to EQ.

C/F Level

Adjust level of Chorus / Flanger signal to EQ.

Reverb Level

Adjust level of Reverb Signal to EQ.

Master Output

Level and Pan of the master output can be adjusted in master section.



Volume

Adjust level of the master output.

Pan

Adjust pan of the master output.

Mute

Turn on to mute master output.

Step Sequencer

Analog Style 8 Step Sequencer to play notes and modulate target parameters.



Step



Step Switch

Turn it on to enable the step.

Slide

Turn it on for previous note to continue on the step when step switch is turned off.

Gate

Adjust amount of Gate signal (Velocity) for the step. Range is from 0% to 100%.

CV

Adjust Amount of CV signal (Pitch) for the step. Range of note value varies by setting of Root Key and Octave Range.

Note

Adjust parameters for note sequencer.



Play

Turn it on to enable sequencer for playing. Tap any key on keyboard to start the sequencer.

Mode

Select an operation mode. Options are off, mono, chord and stack. When chord is selected, use Quantize option to select Minor or Major. Stack mode enable one sequencer to play two synth. Select stack for sequencer of synth1 and synth2 and start one of the sequencer to play both of the synth. Turn it off when sequencer is only used for modulation.

Rate

Adjust frequency of clock to drive the sequencer.

Tempo Sync

Turn it on to enable Tempo Sync.

Quantize

Select a quantize option for CV signal. Options are Off, Minor or Major.

Steps

Select number of steps for the loop.

Gate

Adjust pulse width of gate signal.

KBD Root

Turn it on to set root key by keyboard.

Root Key

Select a Root Key of CV signal. Range is from C-2 to G8 (MIDI 0 ... 127).

Octave Range

Select an Octave Range of CV signal. Range is from 1 to 10 octaves.

Modulation

Adjust speed, amount and target of three modulation sequencer.

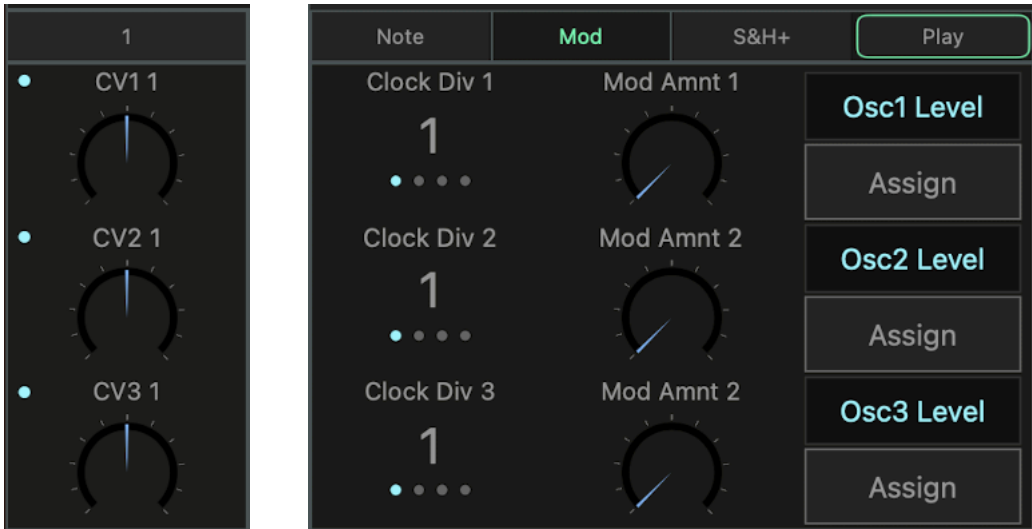

CV 1...3

Adjust amount of CV signal for modulation for the step.

Mod Amount 1...3

Adjust amount of modulation. Range is from 0% to 100.0%.

Clock Division 1...3

Select clock division to adjust speed of modulation. Options are 1, 1/2, 1/4 and 1/8. Speed is faster when amount of division is smaller.

Assign 1...3

Tap on assign button and tap a control of the synth to assign a parameter to modulate.

Sample & Hold

S&H 1 sample and hold signal for note sequencer. S&H 2 & 3 sample and hold signal for modulation 2 & 3.



Hold 1...3

Select number of steps to hold the sampled CV sequences. Options are Off, 8, 16, 32, 64 and 128. When the value is 128, 8 steps are repeated 16 times. Length of the loop is depended on the Clock Rate. Select off to turn off sample & hold.

Src Mix 1...3

Adjust balance of LFO1 and Src 2 signal to be sampled on active step.

Src 2

Select a Src 2 signal. Options are LFO (global) and noise.

Mod Attack

Adjust amount of attack time of modulation signal.

Mod Release

Adjust amount of release time of modulation signal.

Sync with Transport Control

Enable CVSEQ Play Override option for Play/Stop button of build-in piano roll sequencer or host application to start and stop step sequencer.

Enable CVSEQ PLAY OVERRIDE in setting panel.

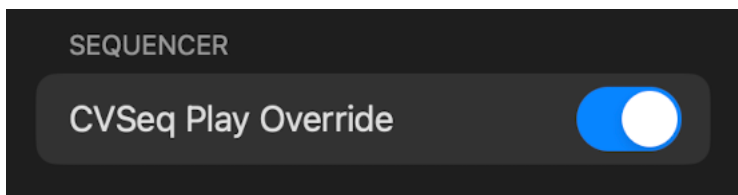

Enable Host Sync when transport is controlled in host application.



Pressing Play Button of build-in piano roll sequencer or transport control of host application starts step sequencer and it is indicated by the play button of the step sequencer.



KBD Control Routing

Default.Default		VCO	VCF+VCA	EG+LFO+EFX	KCV Seq	KBD Ctrl		
Sources		Targets						
Offset Ctrl	Mod Wheel	OSC1 Pitch	OSC1 PW	OSC2 Pitch	OSC2 PW	OSC2 Xmod	OSC3 Pitch	OSC3 PW
	Velocity							
	Aftertouch	CSC3 Xmod	LPF CF	HPF CF	VCA Level	VCA Pan	VCO Pitch	VCO PW
	Poly Pressure							
	Expression	VCO Xmod	Mixer Level	Vibrato Depth	Tremolo Depth	Reverb Send	Chorus Send	Delay Send
Per Note Ctrl								

Select targets to be controlled by Mod Wheel (CC#1), Velocity, Aftertouch, Poly Pressure and Expression (CC#11). Targets are OSC modulations, cutoff of VCF, VCA level, pan, mixer level, vibrato & tremolo depth and effects send.

Default.Default		VCO	VCF+VCA	EG+LFO+EFX	KCV Seq	KBD Ctrl		
Sources		Targets						
Offset Ctrl	Mod Wheel	OSC1 Pitch	OSC1 PW	OSC2 Pitch	OSC2 PW	OSC3 Pitch	OSC3 PW	LPF CF
	Velocity							
	Aftertouch	LPF Reso	LPF Mod	HPF CF	HPF Reso	HPF Mod	VCA Volume	VCA Pan
	Poly Pressure							
	Expression	Vibrato Rate	Tremolo Rate	Vibrato Depth	Tremolo Depth	Reverb Send	Chorus Send	Delay Send
	Per Note Ctrl							

Select targets to be controlled by MIDI Per Note Control Message. Targets are OSC pitch & PW, filter cutoff, resonance & mod amount, VCA volume & pan, vibrato & tremolo rate & depth and effects send.

Velocity, Aftertouch, Poly Pressure, Per Note Control can be controlled by movement of Y axis on key pads of the built-in keyboard. Expression can be controlled by ribbon controller.

Global Control

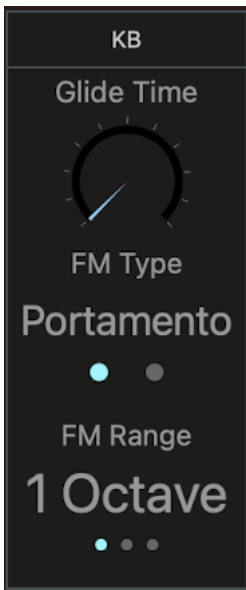

Glide Time

Adjust time of the glide from 10 ms to 10 second. Glide is applied in polyphonic and unison when notes are played in legato.

FM Type

Select a type of frequency modulation. Options are Portamento and Glissando.

FM Range

Select a range of frequency modulation. Options are 1, 2, 4 octaves.

ARP



Arp Pattern

Select a pattern of the arpeggio. Options are up, down, up & down and random.

Arp Rate

Adjust frequency of the clock for arpeggio. When tempo sync is off, range of the frequency is from 1 Hz to 20 Hz. When tempo sync is on, range of the rate is from 1/32 to 1 bars.

Gate

Adjust pulse width of gate signal.

Arp Switch

Turn this switch on to enable arpeggio.

Arp Tempo Sync

Turn this switch on to sync the rate of the clock with tempo.

CH

Select a target of arpeggio. Options are CH1&2, CH1 and CH2.

LFO

This global LFO can be used as a source of modulation which controlled by keyboard as well as providing modulation signal for morphing modulation.



Tune

Adjust frequency of the LFO. When sync is off, range of the frequency is from 0.04Hz to 42.2Hz. When sync is on, range of the rate is from 1/64 to 8 bars.

Shape

Select shape of the LFO waveform. Wave shapes are sine, saw, down saw, square, triangle and random.

Delay

Adjust delay time to start the LFO signal.

Tempo Sync

Turn this switch on to sync the rate of the LFO with tempo.

Key Sync

Turn this switch on to restart the LFO cycle every time a new note is played.

Vibrato

Adjust amount of vibrato can be controlled by aftertouch or mod wheel.

Tremolo

Adjust amount of tremolo can be controlled by aftertouch or mod wheel.

LFO

Adjust amount of LFO modulation can be controlled by aftertouch or mod wheel.

CH

Select a target of LFO modulation of PW, CF and Pan. Options are CH1&2, CH1 and CH2.

PW Amount

Adjust amount of pulse width modulation by LFO.

CF Amount

Adjust amount of LPF cutoff modulation by LFO.

Pan Amount

Adjust amount of pan modulation by LFO.

Ring Modulator

Ring modulator generate sum and difference frequency of synthesizer signal and modulator signal. Amount of modulation and speed can be adjusted. Envelope changes speed of modulation when key is pressed.



Attack

Adjust attack time of envelope to modulate speed (frequency) of modulator.

Decay

Adjust decay time of envelope to modulate speed (frequency) of modulator.

Depth

Adjust amount envelope to modulate frequency of modulator.

Speed

Adjust speed (frequency) of modulator.

Mod Amount

Adjust amount of ring modulation between output of synthesizer and modulator.

CH

Select a target of ring modulation. Options are CH1&2, CH1 and CH2.

Morph

Adjust balance of CH1 & CH2 output. Adjust amount of Global LFO to modulate the balance of mix.



Stereo

Adjust stereo position of output from CH1 & 2.

Mix

Adjust balance of output from CH1 & 2.

Mod

Adjust amount of LFO (global) to modulate mix.

Offset Control

Offset control can offset values of target parameters. When set value of offset to zero, target parameters are back to the original values.



CH

Select a target of control. Options are CH1&2, CH1 and CH2.

Pitch

Select pitch range. Options are coarse and fine. Range of coarse is +/- 1, 2, or 4 octaves depend on FM Range setting. Range of fine is +/- 50 cents.

Mod

Turn it on to modulate parameters by LFO (global). Each parameters control amount of the modulation.

OSC 1...3 Pitch

Adjust offset of oscillator's pitch.

OSC 1...3 Shape

Adjust offset of oscillator's shape.

OSC 1...3 PW

Adjust offset of oscillator's pulse width.

OSC 1...3 Level

Adjust offset of oscillator's level.

Cutoff (LPF, HPF)

Adjust offset of cutoff.

Resonance (LPF, HPF)

Adjust offset of resonance.

Mod (LPF, HPF)

Adjust offset of modulation.

VCA Level

Adjust offset of VCA level.

Pan

Adjust offset of pan.

AM

Adjust offset of amplitude modulation amount.

Delay

Adjust offset of delay send.

C/F

Adjust offset of c/f send.

Reverb

Adjust offset of reverb send.

ENV 1,2 Attack

Adjust offset of attack time

ENV 1,2 Sustain

Adjust offset of sustain level.

ENV 1,2 Release

Adjust offset of decay/release time.

Assignable Controllers



Tap “Assign” button and tap on a control to assign the parameter to the control.

Macro Factory Presets

Four factory presets, Global, ChannelStrip, Effects and KBD Mod can be used to set parameters to Assignable Controllers.

Effects

Delay

Signal Flow

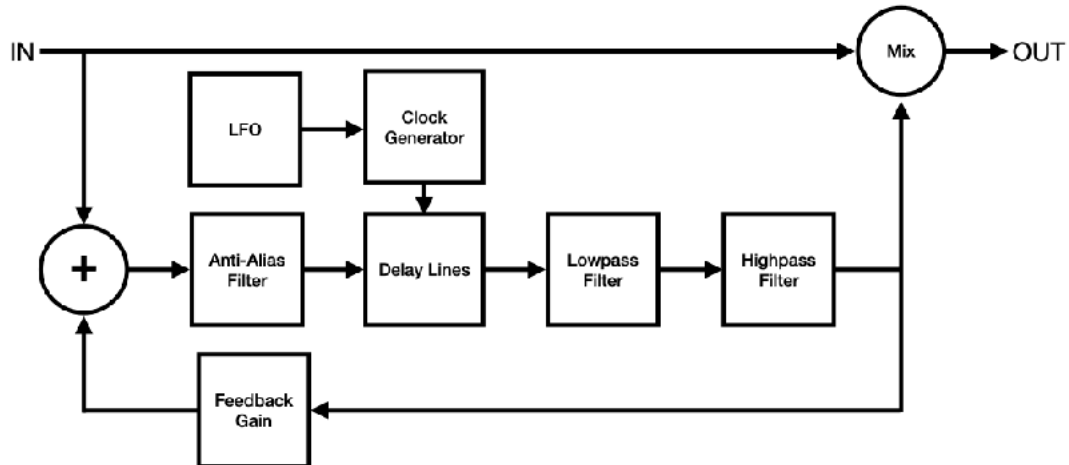

Delay Time

Adjust delay time from 20 ms to 1200 ms. When sync switch is turned on, delay time can be set as note value which is synchronized to the tempo. Valid range of the note value is automatically adjusted base on the current tempo.

Regeneration

Adjust feedback from 0 % to 100 %. You can change sound of the feedback by adjusting frequency of the high-pass filter and the low-pass filter.

Modulation

Modulation can be applied to the delayed signal. LFO (Low Frequency Oscillator) generates sine wave for the modulation.

Adjust LFO frequency from 0.01 Hz to 10 Hz.

Adjust LFO Intensity from 0 to 1.0, which adjust modulation width from 0 ms to +/- 10 ms.

Chorus / Flanger

Signal Flow

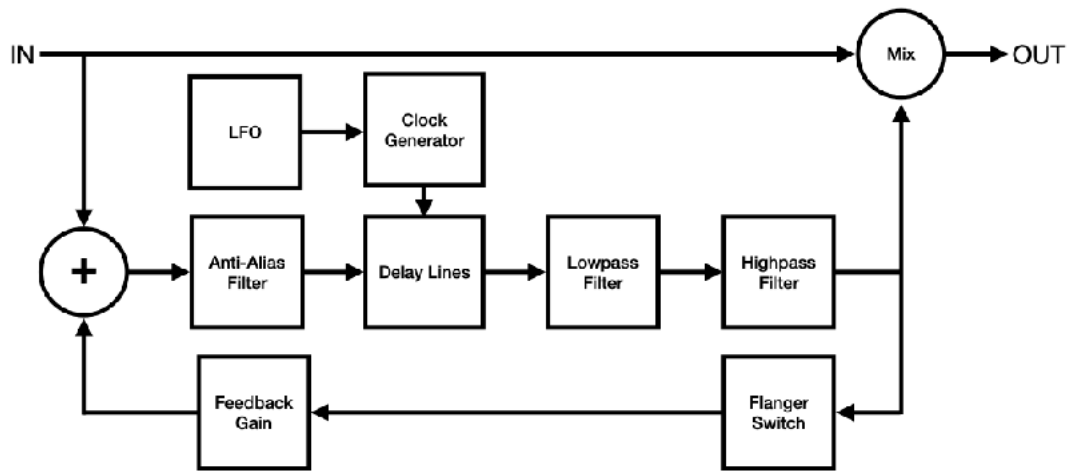

Input Signal Level

Level of input signal should be about -6dB or less. If the input signal is too hot, it will cause distortion in output signal.

Effect Type

Select effect type from chorus or flanger. Ranges of the delay time and the LFO Intensity change based on the selected effect type.

Modulation Speed

LFO Frequency dial controls speed of the modulation. When sync switch is turned on, LFO Frequency can be set as note value which is synchronized to the tempo. Valid range of the note value is automatically adjusted based on the current tempo.

Modulation Width

LFO Intensity dial controls width of the modulation and delay time dial controls center position of the modulation.

When chorus effect is selected, range of the LFO intensity is from 0 ms to 1 ms and range of the delay time is from 1 ms to 40 ms.

When flanger effect is selected, range of the LFO intensity is from 0 ms to 12 ms and range of the delay time is from 1 ms to 13 ms.

Rotate delay time dial counterclockwise to emphasize higher frequency or clockwise to emphasize lower frequency.³

LFO Shape

LFO shape dial controls shape of the LFO waveform. When the dial is rotated fully counterclockwise, shape of the waveform is sine wave. When the dial is rotated fully clockwise, shape of the waveform is triangle wave.

Stereo Width

Stereo Width dial controls phase offset of the LFO. When the dial is rotated fully counterclockwise, stereo width is 0%. (phase offset is 0 degree) When the dial is rotated fully clockwise, stereo width is 100%. (phase offset is 180 degree)

Regeneration

Feedback dial controls amount of regeneration from 0 % to 100 %. Turning the feedback dial clockwise enhances amount of the feedback effect.

³ If compared with manual knob of the analog flanger guitar pedal, emphasized frequency moves reverse direction.

Filters

Delayed signal is routed to high-pass filter and low-pass filter before mixed with dry signal. HP frequency controls frequency of the high-pass filter. LP frequency controls frequency of the low-pass filter.

Reverb

Signal Flow

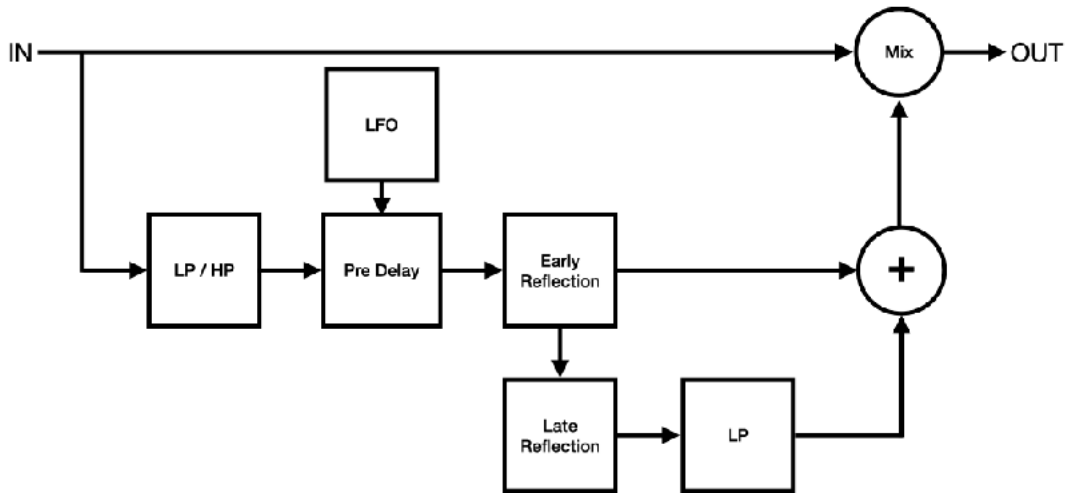

Input Filter

Use Lowpass filter and high-pass filter to attenuate high frequency and low frequency of the input signal.

Pre Delay

Use pre delay to adjust amount of the time between the direct signal and beginning of the early reflection signal. This parameter can be used to express size of the space. Reflection takes short time to bounce back in small room and it takes long time in large room. Also this parameter can be used to separate dry signal and reverb signal in the mix.

Modulation Speed

LFO Frequency dial controls speed of the modulation. When sync switch is turned on, LFO Frequency can be set as note value which is synchronized to the tempo. Valid range of the note value is automatically adjusted base on the current tempo.

Modulation Width

LFO Intensity dial controls width of the modulation and pre delay time dial controls center position of the modulation. Range of the LFO intensity is from 0 ms to +/- 10 ms.

Size and Decay

Size dial controls reverb time of late reflection and decay dial controls length of the reverb tail. Decay time can be used to express size of the space and material of the surface. Reflective materials, such as concrete or hardwood, gives longer decay time.

When auto size switch is turned on, size dial controls value of the parameters including size, pre delay, decay, damp, output LP frequency and early/late mix.

When sync switch is turned on in auto size mode, total reverb length, which can be controlled by pre delay, size and decay, is adjusted by note value which is synchronized to the tempo.

Damping

Damp dial controls amount of high frequency absorption for the late reflection signal. Low damping values produce brighter reverb sound and high damping values produces darker reverb sound.

Output Filter

Use lowpass filter to cut high frequency of the reverb signal.

Early / Late Mix

Adjust balance of the early reflection signal and late reflection signal from 0% (early reflection) to 100% (late reflection).

Equalizer

Low Shelving

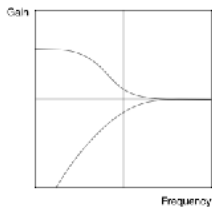

Adjust frequency of the filter from 21 Hz to 1092 Hz.
Adjust gain from minus infinity to +12 dB
When gain is turned fully anti clock wise, the filer becomes high pass filter.

Mid Peak / Notch

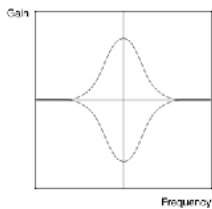

Adjust frequency of the filter from 151 Hz to 2389 Hz.
Adjust gain from -14 dB to +14 dB
Bandwidth is fixed to one octave.

High Shelving

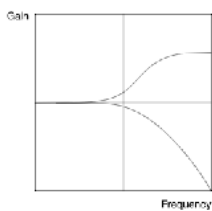

Adjust frequency of the filter from 296 Hz to 21096 Hz.
Adjust gain from minus infinity to +12 dB
When gain is turned fully anti clock wise, the filer becomes low pass filter.

Compressor

Overview

The compressor reduces dynamic range of audio signal. This is achieved by feedback topology as shown in the diagram below.

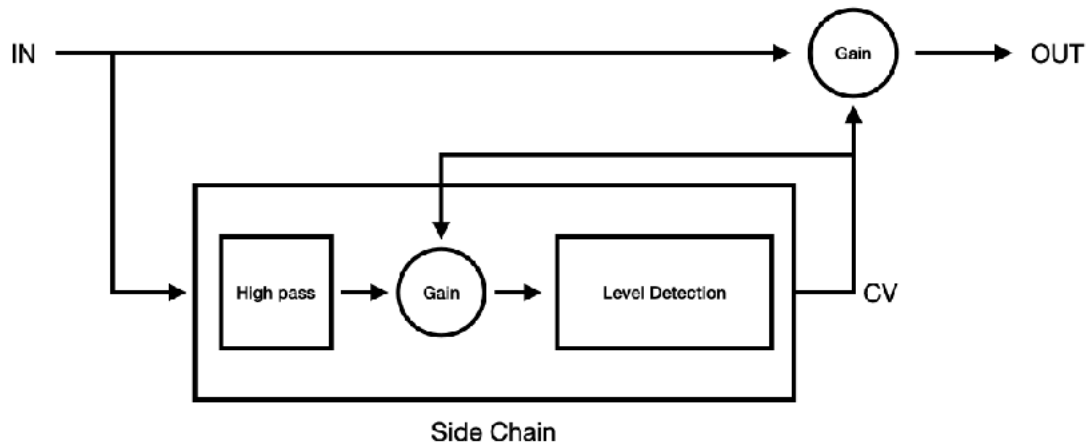

High pass filter is applied to the input of the side chain and the signal is routed to the gain stage in the side chain. The output of the gain stage is routed to the level detection. The level detector detects level of the input signal and generates control signal based on the level of the gain reduction required. The control signal is routed to the amplifier in the gain stage in the side chain to adjust level of the input signal from the high pass filter. The same control signal is also routed to the amplifier of the main gain stage to adjust level of the input signal.

The feedback topology is common in early analog compressors. Although there are several disadvantages to this topology, it is considered more musical than feed-forward design used in modern compressors. The feedback loop is implemented without unit delay to emulate behavior of the analog circuit.

Threshold and Ratio

When level of the input signal passes above the threshold, the input signal is compressed by the ratio.

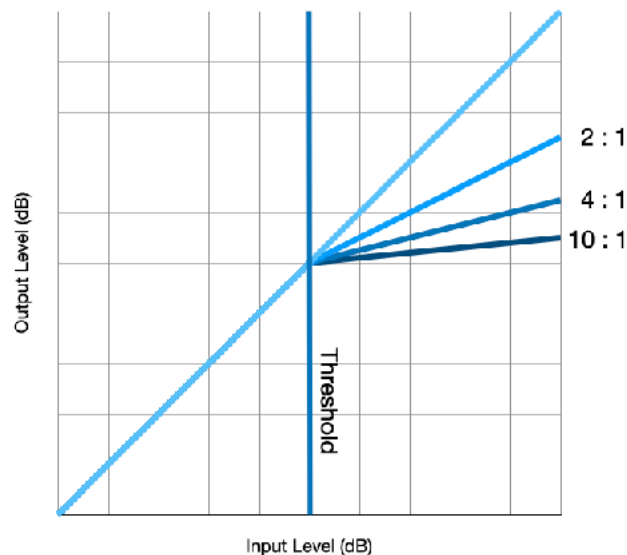

Attack and Release

Attack is the time it takes for the signal to be compressed by the given ratio. Release is the time it takes the gain reduction to return to zero.

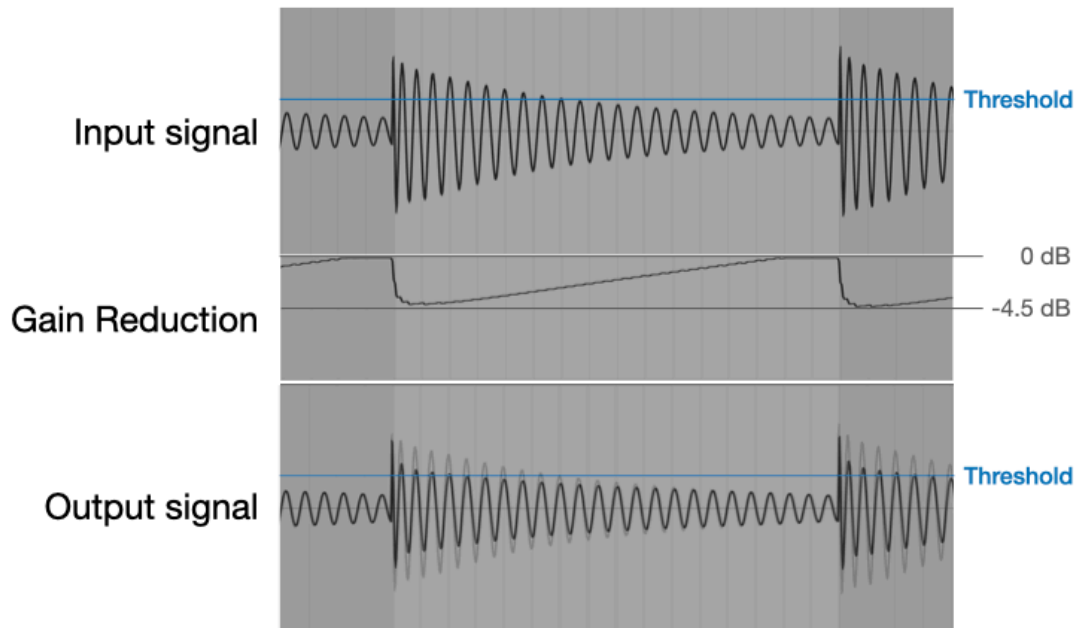

In this example, attack is 1 ms and release is 0.6 s. The initial transient pass through the compressor without gain reduction. It takes a while for the gain reduction to return to 0 dB after the input signal goes below the threshold.

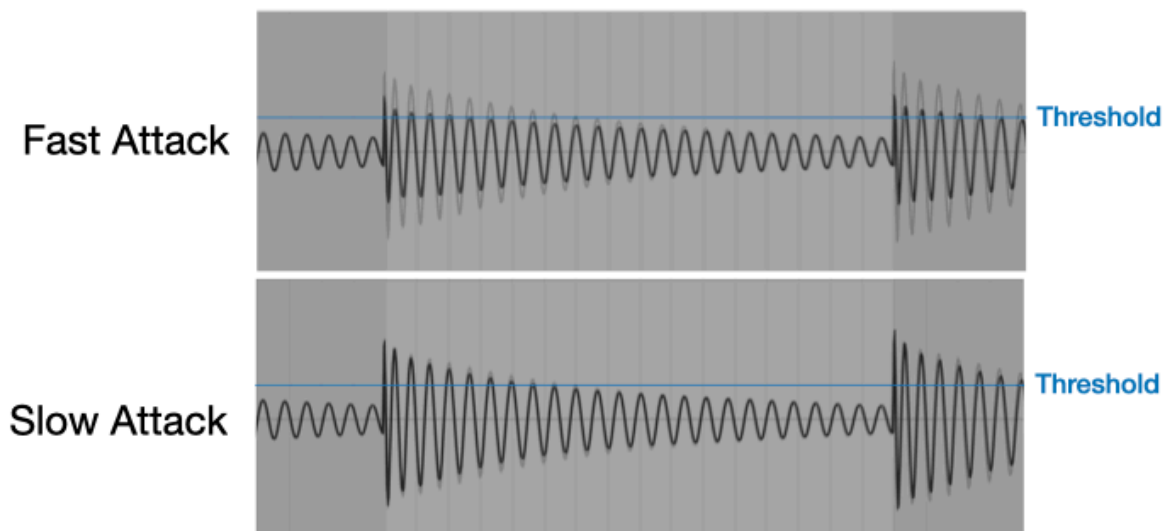

Fast attack makes compressor to start gain reduction immediately after the input signal passes above the threshold. Slow attack, on the other hand, allows many of the transients to pass through compressor without gain reduction.

The figures below illustrate characteristic of the attack and the release. 1KHz Sine wave is used as an input signal (shown as transparent background images). It shows how compressor reacts with various combination of the attack and release settings.

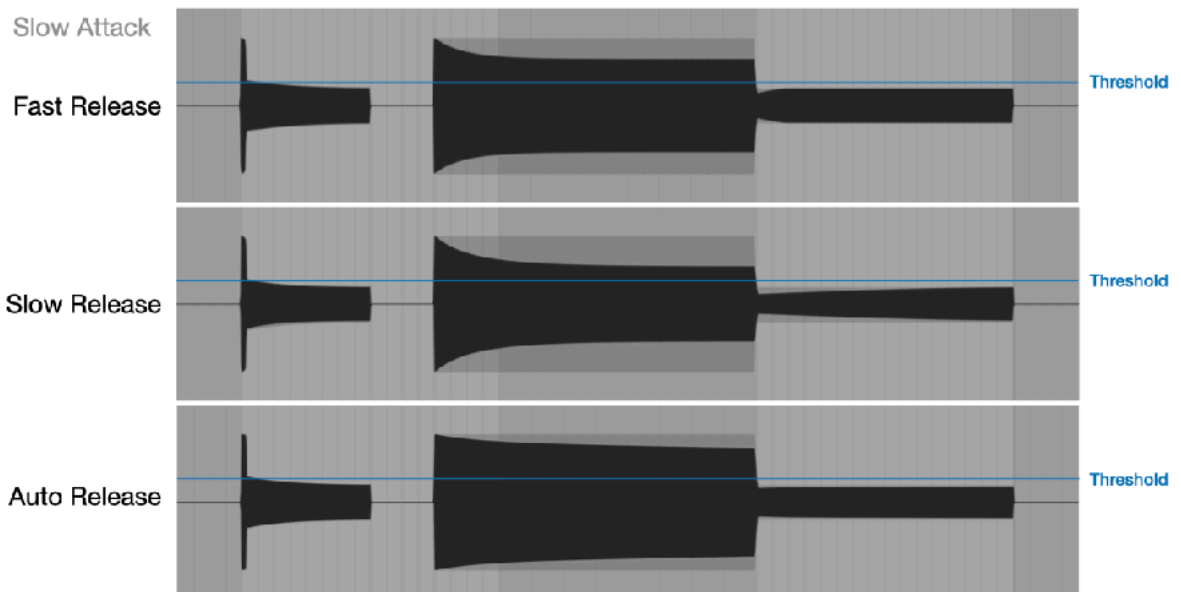
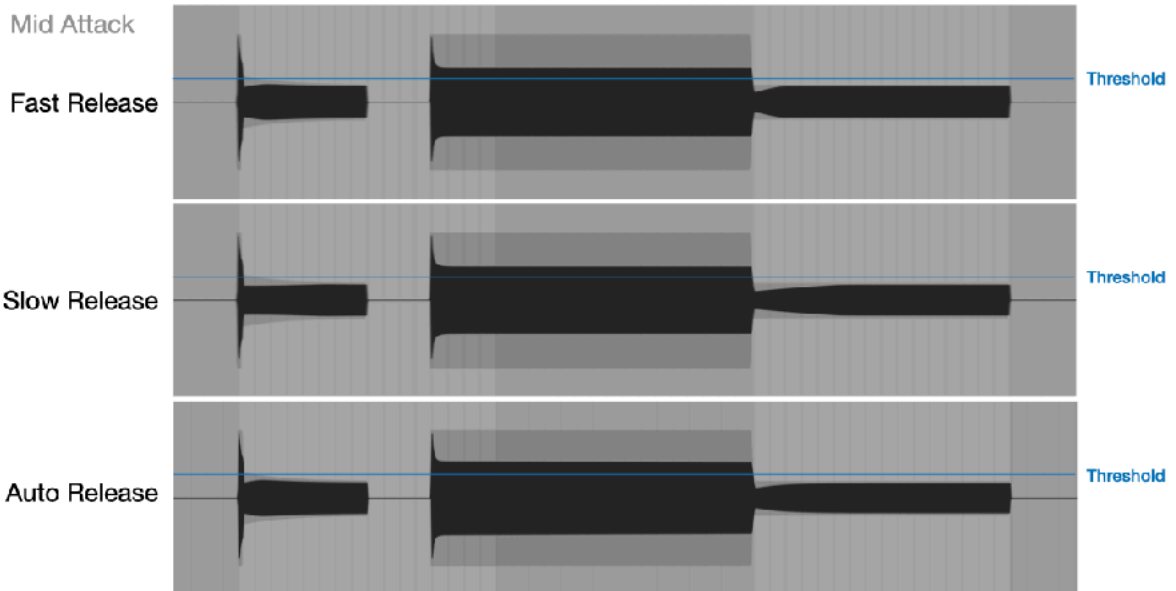
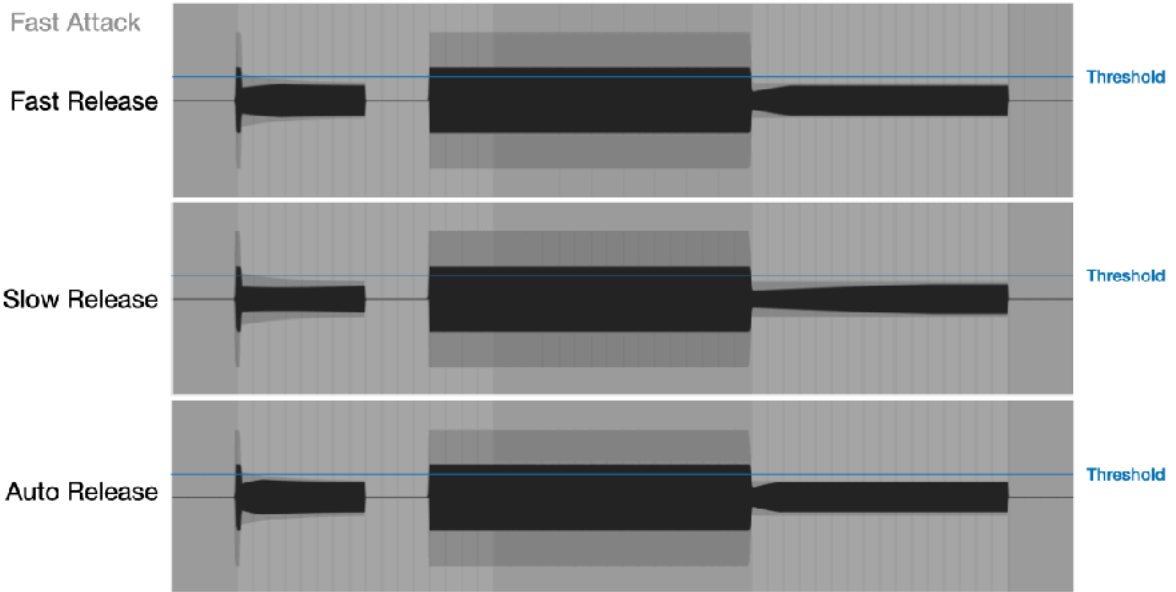

Auto Release uses two time constants for the peak detector. It will react differently for the short transients and the long sustained sound.

Fast attack reduces the level of the transients and make sound soft, slow attack allows transients to pass through and gives a punch to the sound.

Fast release causes pumping and breathing effects. Slow release continues to reduce level for a long period of time after compressing louder part of the sound.

Side Chain High Pass Filter

-6 dB / octave high pass filter is applied to the input signal of the side chain. Frequency range is from 20 Hz to 185 Hz. This filter removes low frequency information from the input signal for the level detector to control excessive gain reduction and pumping effect.

Makeup Gain

Use Makeup to compensate the gain reduced by the compressor. The range is from 0 dB to 20 dB. Gain reduction meters show the amount of the gain reduction. You can use the information to adjust level of the makeup gain.

Gain Reduction Meter

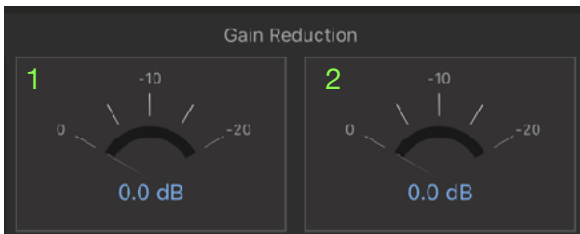

Gain reduction meters show peak level of the gain reductions in dB.

1. Gain reduction for the left channel
2. Gain reduction for the right channel

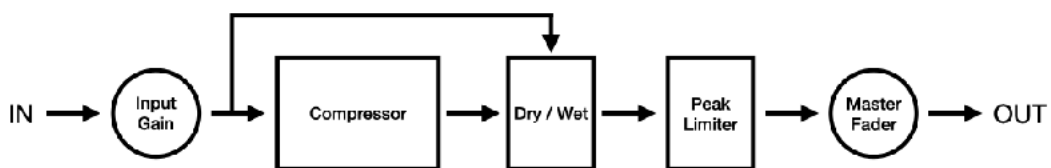

Input Gain

Adjust gain of the input signal routed to the compressor. The range is from -20 dB to 20 dB. When level of input signal is increased, GR meters show gain reductions even if threshold is set to 0 dB.

Dry / Wet

Use Dry / Wet to mix uncompressed signal (dry) and compressed signal (wet). Parallel compression technique, also known as New York compression can be achieved by adjusting amount of the wet signal mixed with the dry signal. When set to 0%, output is the dry signal. When set to 100%, output is the wet signal. When set to 50%, equal amount of the dry and the wet signal are mixed for the output.

Peak Limiter

Peak Limiter is an analog style limiter and provides clean sounding output signal. This limiter is not a lookahead brick wall limiter, so that it can't offer brick wall limiting. However it does not introduced any latency to the output signal.

Frequency response of the peak limiter is illustrated in the figure below. Output signal shows the result of 1 dB gain reduction.

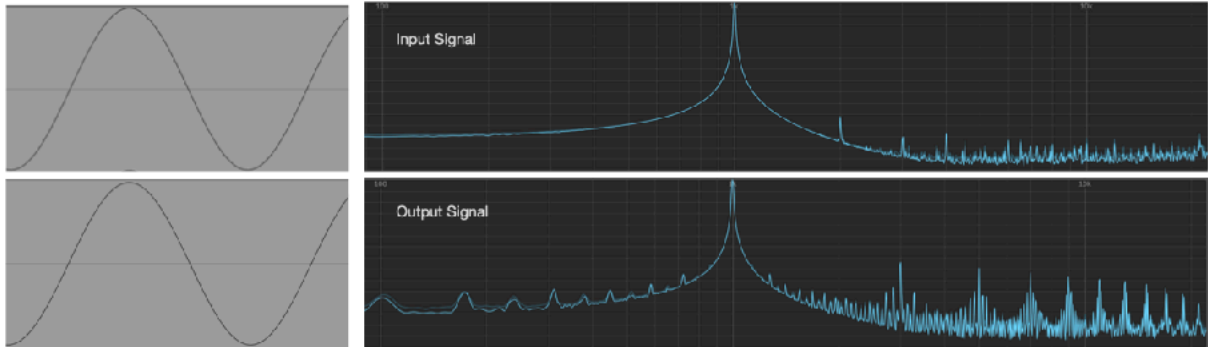

Keyboard

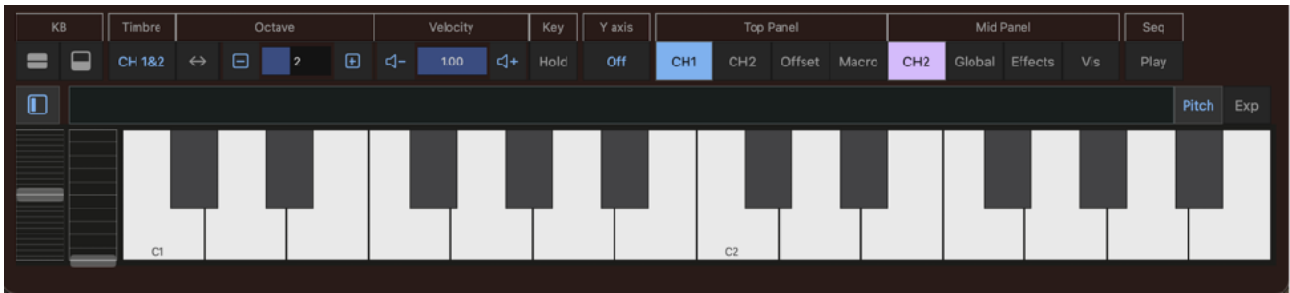

Select Keyboard



Tap keyboard button in tool bar to show keyboard.

Select Key Range

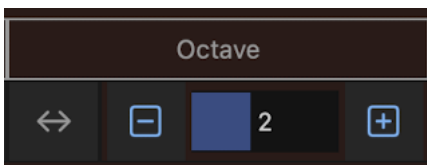

Use plus / minus buttons to adjust range of the keyboard. Indicator shows octave of lowest note of the keyboard. Tap on arrow button to enable keyboard scrolling.

Use Modulation Wheel

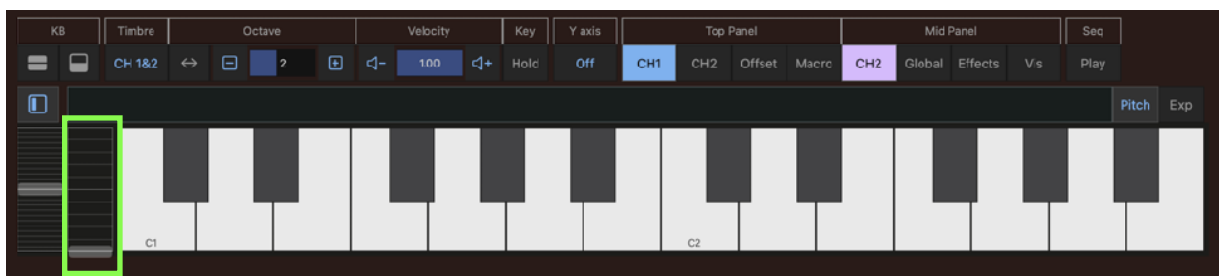

Adjust amount of the modulation when Mod Wheel is selected in modulation source.

Use Pitch Wheel

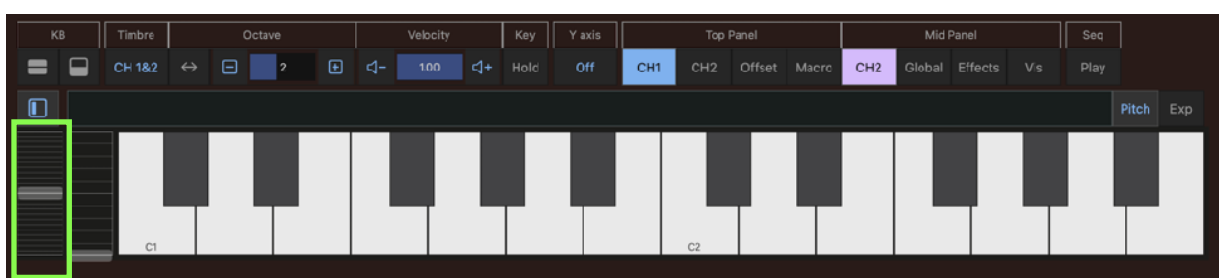

Adjust pitch of the oscillators. Range is +/- 1, 2, or 4 octave can be adjusted by FM range option.

Set Velocity



Use plus / minus buttons to adjust velocity.

Use Key Hold

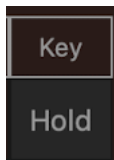

Tap to Enable/Disable Key Hold.

Y-Axis (Per Note Control)



Select a target can be controlled by y-axis movement of key on keyboard. Options are off, pitch, pressure and ctrl.

Top & Mid Panel



Select a content of top panel and mid panel.

Sequencer Play

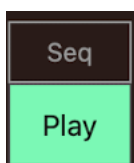

Turn it on to enable sequencer for playing. Tap any key on keyboard to start sequencer.

Select Timbre

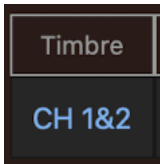

Select a timbre which can be controlled by keyboard.

Show Double Keyboard



Tap a button on left to show Double Keyboard. Tap a button on right to select a keyboard to control.

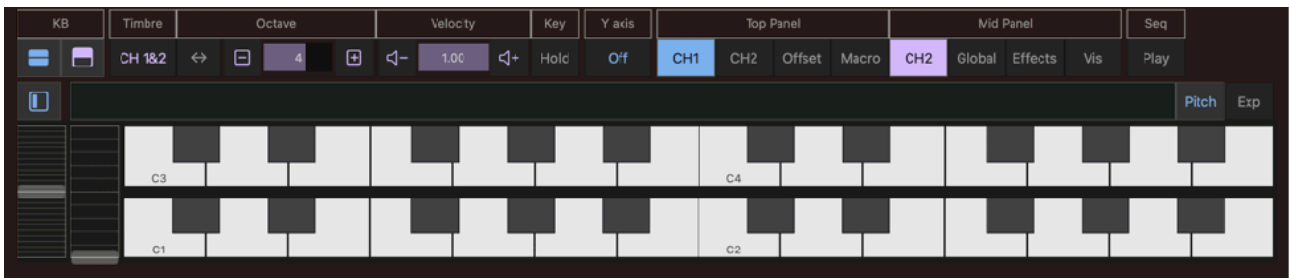
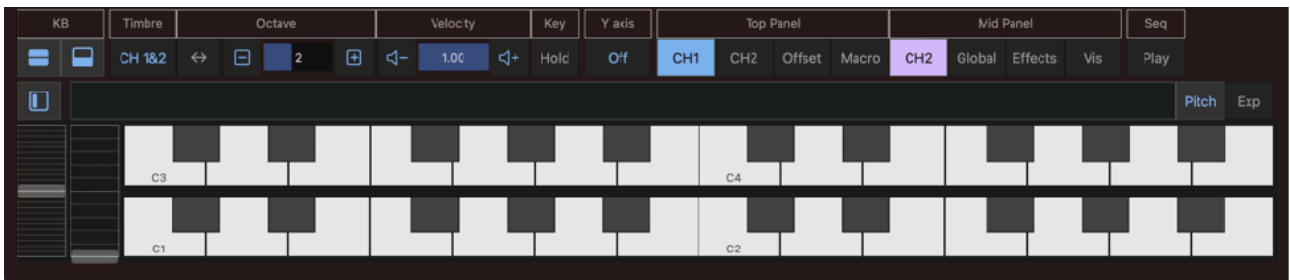

Ribbon Controller

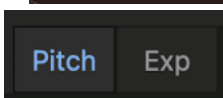
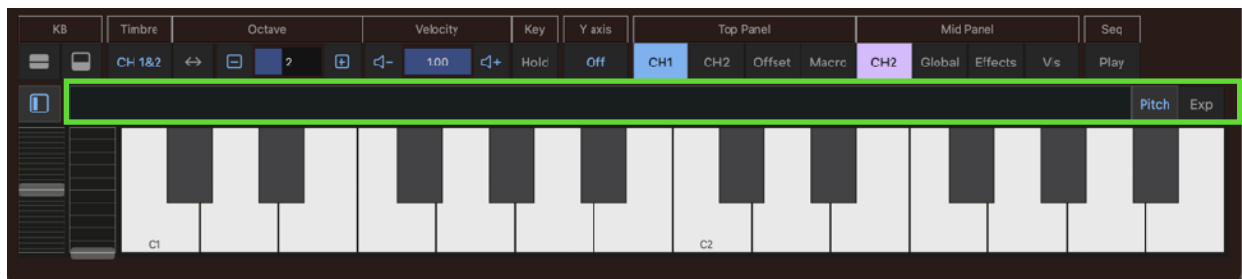

Select a targets of Ribbon Controller. When Pitch is selected, dragging the Ribbon Controller applies linear pitch bend. When Exp (Expression) is selected, expression is controlled by ribbon controller. Targets of the expression can be selected in KBD Control Routing Panel.

Sequencer

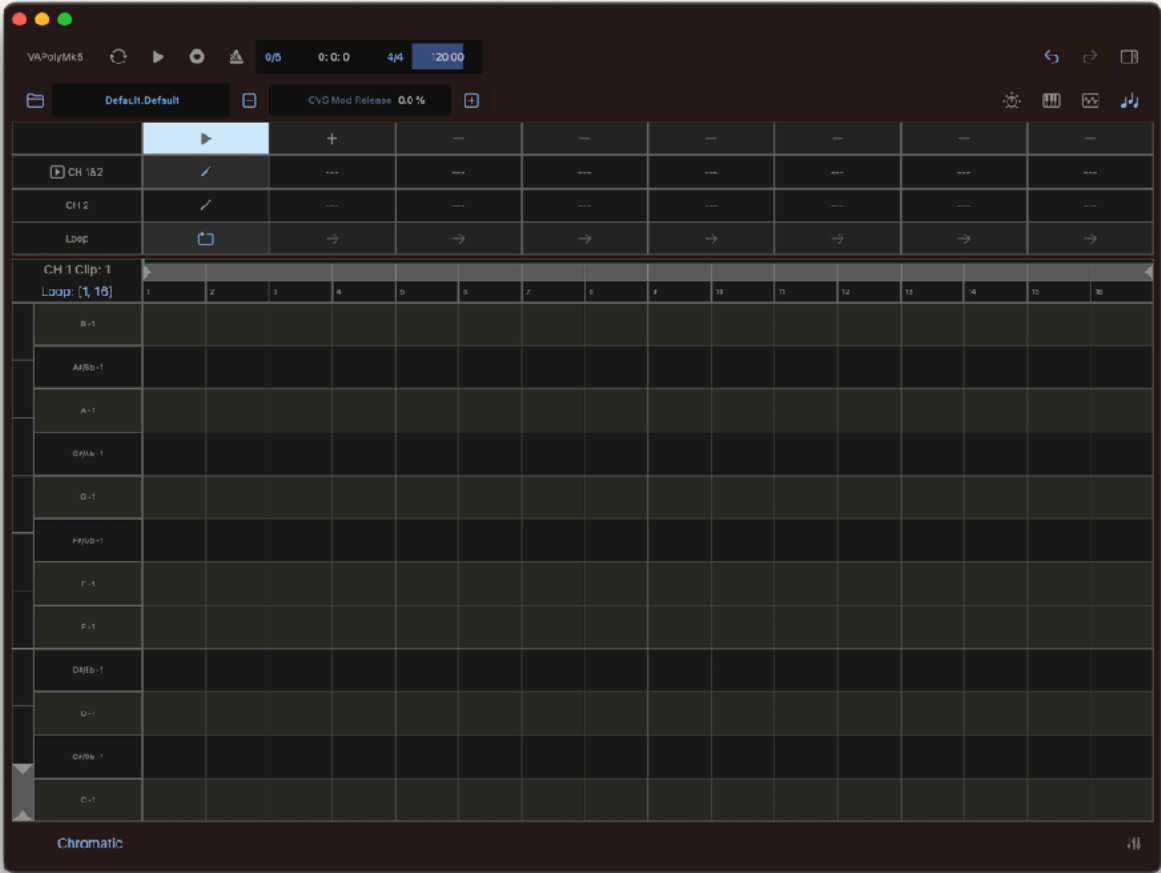

Clip Editor

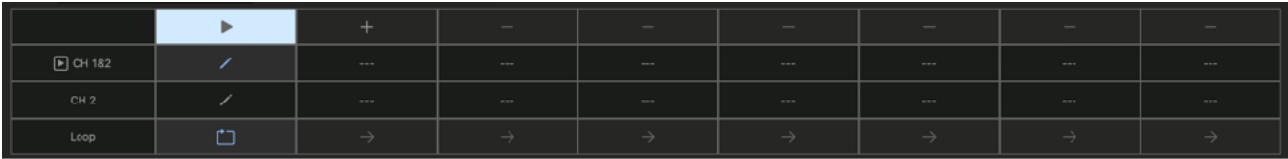

Each clip contains note event and parameter automation events for length of 16 bars. Maximum number of clips are 8.

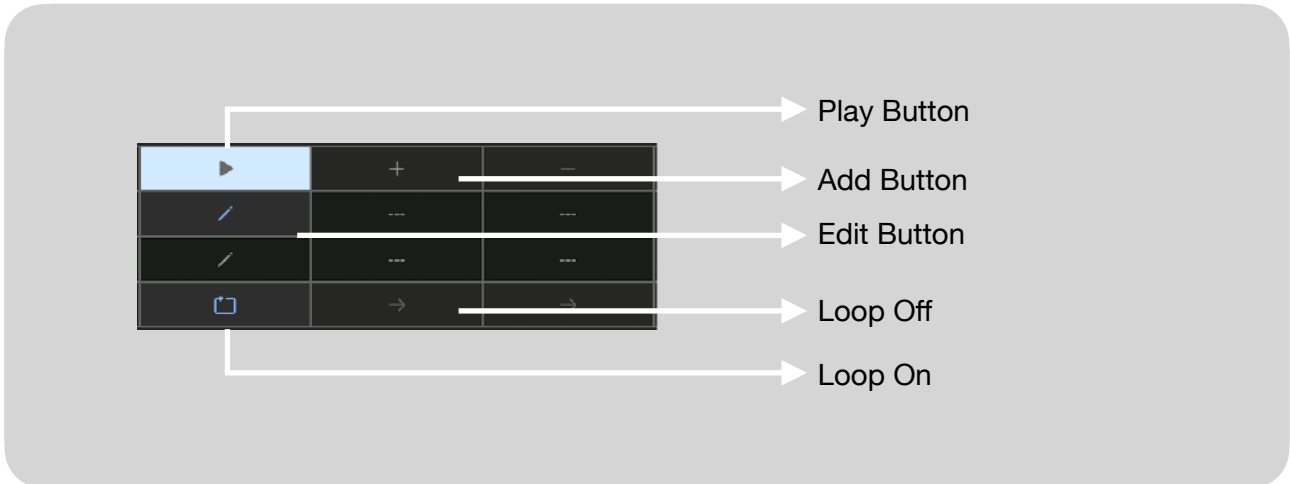

Load Clip

Tap load button to load clip to make it active.

Play/Stop Clip

Tap play button to play/stop clip.

Edit Piano Roll

Tap edit button to open piano roll editor.

Add edit button

Tap plus button to add edit button.

Set Loop Mode

Tap this button to enable/disable loop mode. When loop is off, tap square icon to select a clip to play next.

Auto Select Editor

Tap Synth Row Label to toggle Auto Select Editor Switch. When Auto Select is enabled, editor changes while playing sequence.

Piano Roll Editor

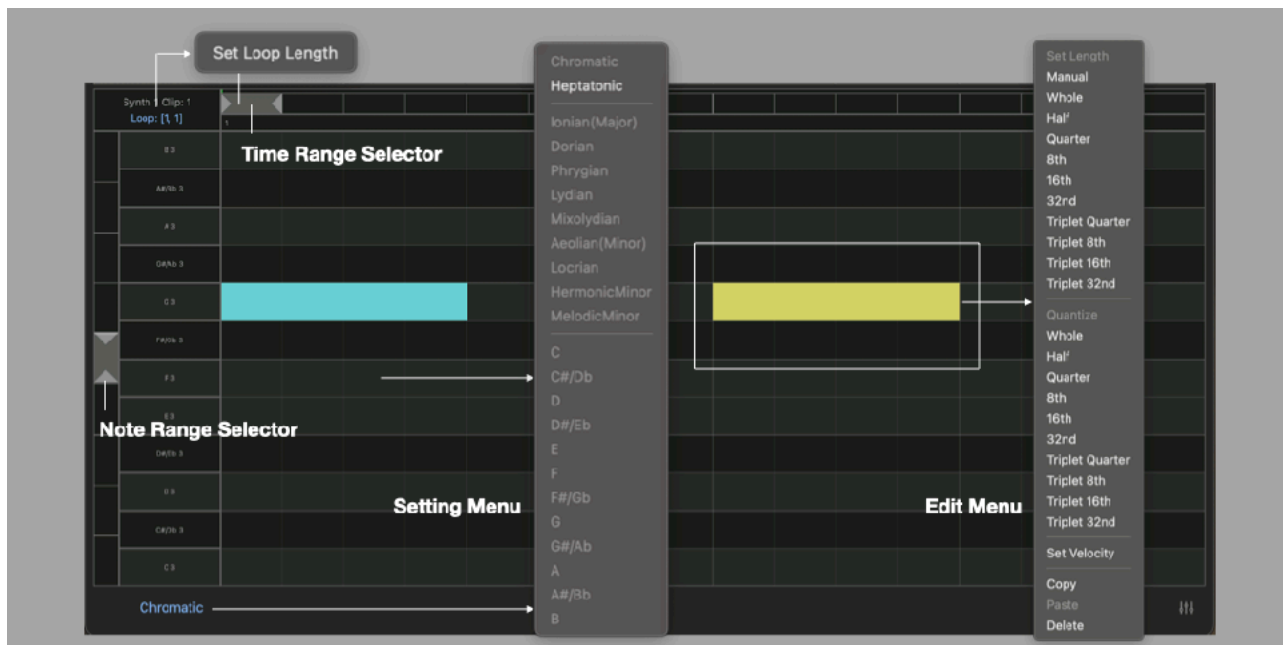

Select Time Range and Loop Length

Use “Time Range Selector” to select Time Range for editing and Loop Length. On iOS, pinch gesture control zooming and drag gesture control scroll position.

To set Loop Length, tap on Loop Length button to show menu and select “Set Loop Length”. Right click on selector on Mac also show the menu.

Select Note Range

Use “Note Range Selector” to select note range for editing. On iOS, pinch gesture control zooming and drag gesture control scroll position.

Add Note

Double tap to add a note.

Delete Note

Select note and select Delete from context menu.

Scale Menu

Press and hold (right click on macOS) editor to show scale menu. Tap on scale button also shows the menu.

Edit Menu

Press and hold (right click on macOS) selected note to show edit menu.

- Chromatic
- Heptatonic**

- Ionian(Major)
- Dorian
- Phrygian
- Lydian
- Mixolydian
- Aeolian(Minor)
- Locrian
- HermonicMinor
- MelodicMinor

- C
- C#/Db
- D
- D#/Eb
- E
- F
- F#/Gb
- G
- G#/Ab
- A
- A#/Bb
- B

Chromatic Scale

Select Chromatic to edit notes in Chromatic Scale (12 tones).

Heptatonic Scale

Select Heptatonic to edit notes in Diatonic Scale, Harmonic Minor Scale or Melodic Minor Scale (7 degrees).

Root Key

Select a root key, when editing note in Diatonic Scale, Harmonica Minor or Melodic Minor Scale.

- Set Length
- Manual
- Maximum
- Whole
- Half
- Quarter
- 8th
- 16th
- 32nd
- Triplet Quarter
- Triplet 8th
- Triplet 16th
- Triplet 32nd

- Quantize
- Whole
- Half
- Quarter
- 8th
- 16th
- 32nd
- Triplet Quarter
- Triplet 8th
- Triplet 16th
- Triplet 32nd

- Hide Velocity

- Copy
- Paste
- Delete

Set Length
Select an option to set note length.

Quantize
Select an option to quantize note.

Set Velocity
Open velocity editor to edit note velocity.

Copy
Copy selected notes.

Paste
Paste notes.

Delete
Delete selected notes.

Velocity Editor

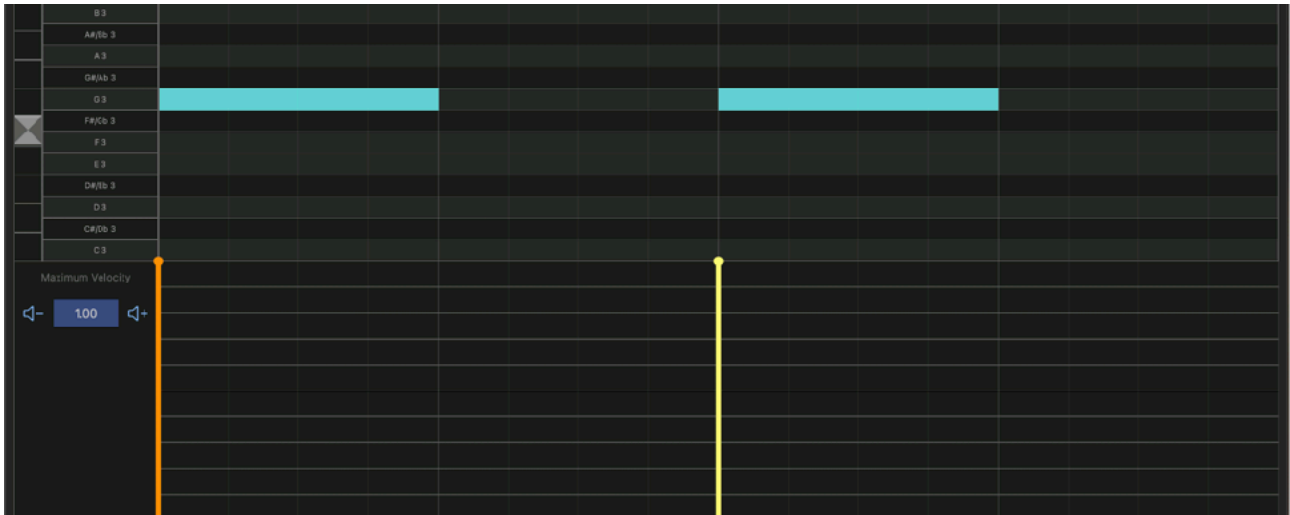

1. Select a note and open context menu.
2. Select "Set Velocity" in context menu
3. Select velocity sliders and adjust the velocity. Indicator in side bar shows maximum velocity in the selection. Maximum velocity value can be adjusted by plus and minus button and slider of the indicator.

Parameter Automation Editor

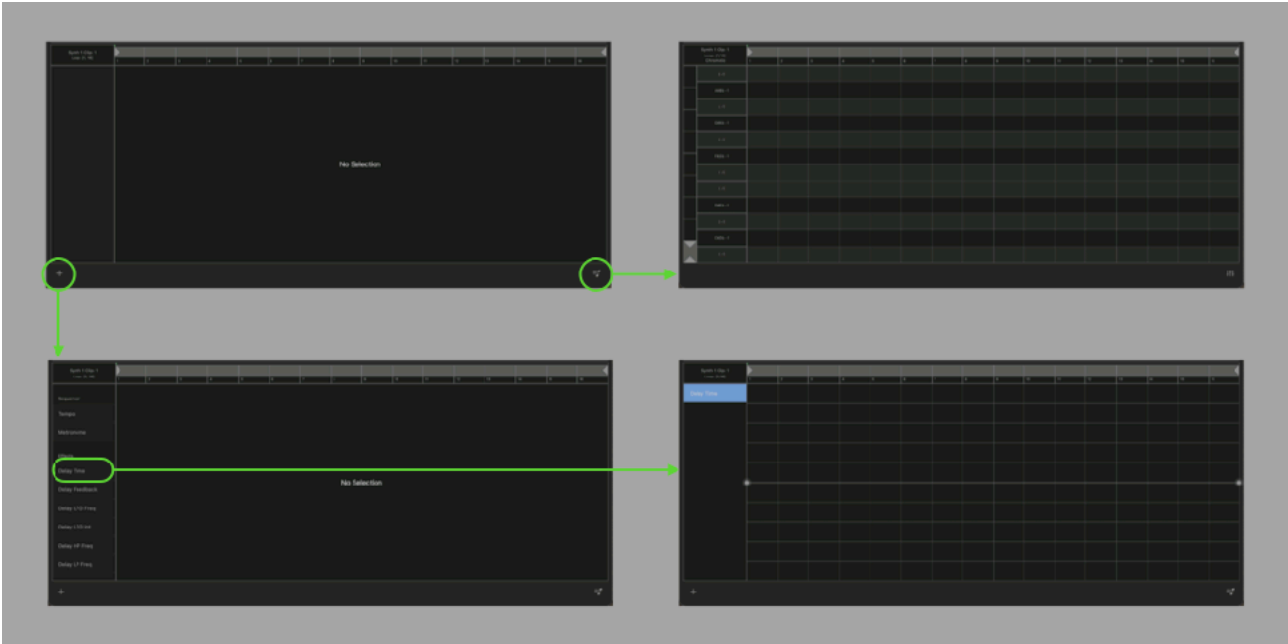

1. Tap plus button to show parameter list.
2. Select a parameter to edit.
3. Press and hold (right click on macOS) on parameter name to show context menu. Tap Delete to delete the parameter form editor.

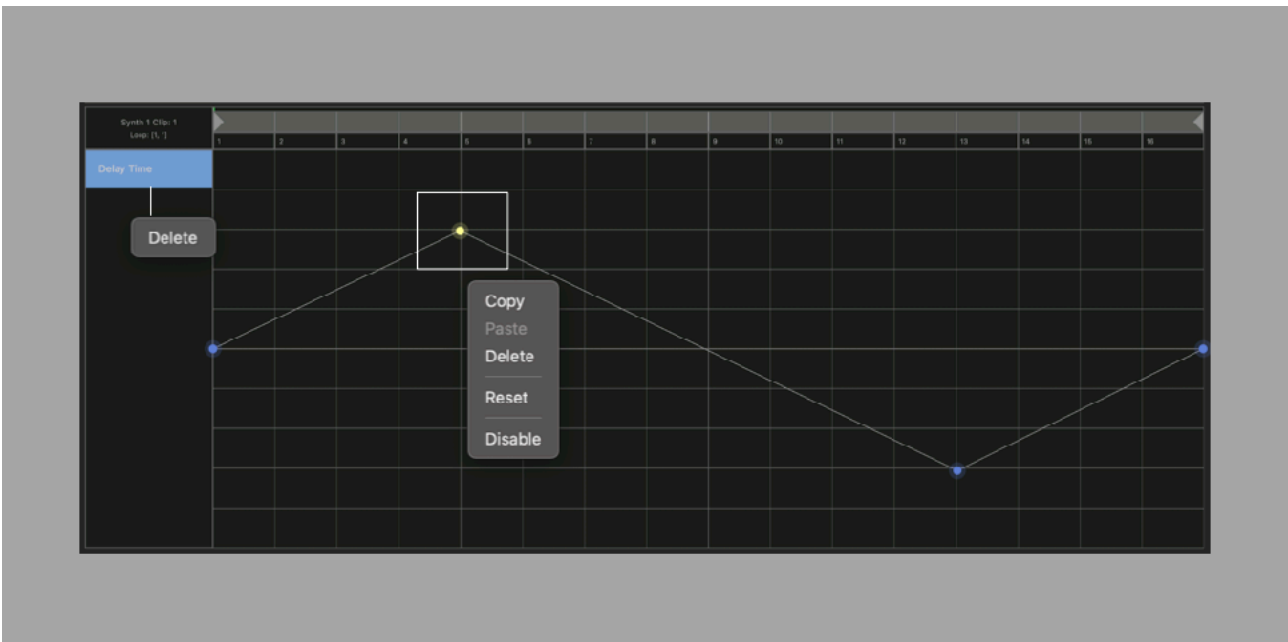

4. Double tap to add an edit point.
5. Select edit points and press and hold (right click on macOS) on editor to show context menu.
6. Select Reset from context menu to reset the parameter.
7. Select Disable to inactivate automation.

Play Sequence

1. Set host sync

Tap sync button in transport bar to enable / disable sync mode.

When sync mode is enabled,

Stand Alone

Sequencer is synced to the clock provided by container application. The container application can use Ableton Link to synchronized with the Link enabled devices. Use buttons in transport bar to play / stop sequence and change tempo.

Plugin

Sequencer is synced to the clock provided by the host application. Use transport switches of the host application to play / stop the sequence and change tempo.

When sync mode is disabled,

Sequencer is driven by internal clock. Use buttons in transport bar to play / stop the sequence and change tempo.

2. Set tempo

Tap plus / minus button at the tempo section in the transport bar to open tempo slider. Tempo can be adjusted by the plus / minus buttons and the tempo slider. Tempo slider can adjust tempo by range of plus/minus 20 BPM. Double tap on the slider set center position to the current tempo value. Alternatively tapping on tempo indicator allows you to type in tempo value by computer keyboard.

3. Set loop

Use Time Range Selector to set loop length.

4. Set swing

Tap swing button in transport bar to show swing menu. Select an option from the menu to apply the swing. —

Swing Type	Delay time	Duration (Ratio)	Note
Swing 0/6	0 (no swing)	50%	Straight
Swing 1/6	1/6 of 16th note	54%	Soft swing
Swing 2/6	2/6 of 16th note	58%	Soft swing
Swing 3/6	3/6 of 16th note	62%	Soft swing
Swing 4/6	4/6 of 16th note	66%	Triplet swing
Swing 5/6	5/6 of 16th note	70%	Hard swing
Swing 6/6	16th note	75%	Dotted hard swing

Delay time is an amount of delay applied to the third 16th note when a beat is divided by four 16th notes.

Duration (ratio) is a ratio of duration from the first 16th note to the third 16th note when a beat is divided by four 16th notes.

Amount of delay for the notes in a beat changes proportionally.

5. Set metronome switch

Tap metronome button in transport bar to enable / disable metronome.

6. Play

Tap play / stop button in transport bar or transport switches of the host application to play / stop the sequence.

Record Sequence

1. Set recording mode

Tap record button in transport bar to enable recording mode.

2. Play sequence

Play the sequence by following the steps described above. Recording will start after count-in. When tap recording button while playing, recording start without count-in. To start recording without count-in, play sequence first then tap record button.

3. Record notes

Play keypads or MIDI keyboard to record notes. Notes are automatically quantized at 16 step position.

4. Record parameters automation

Before recording parameter values, use edit command "Reset to Dial Value" to reset values of the parameter to the rest position.

Turn a dial or switch to record the parameter values. The color of the control changes to green to indicate the parameter is recorded. The control won't move automatically until disabling the recording mode in order to move the control freely during the recording.

If the synth or the effects is not producing sound, parameter value will not be recorded.

5. Stop recording

Tap record button in transport bar to disable recording mode or tap play button to stop playback.

Preset

User Preset contains values of the synth parameters and the sequence data. When loading a user preset, value of the synth parameters and the sequence data are both changed. User Presets can be saved in iCloud Drive or in AUv3 plug-in on the device.

To save user preset in iCloud drive, select Save in File Menu. User Presets in iCloud Drive can be accessed from iPhone, iPad or Mac.

To save user preset in plug-in, tap Add button in Preset Browser. Plug-In Preset is stored on the device and can be accessed from any host application which support AUv3 User Preset.

Factory presets contains only values of parameters of the synth and the effects. It doesn't contain any sequence data. When loading the preset, it will change the value of the parameters but sequence data remains the same.

To load factory presets, select a preset in Preset Browser.

File Menu

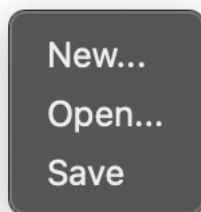

New...

Reset parameters and sequence data.

Open...

Open a preset from iCloud drive.

Save

Save a preset in iCloud drive.

Preset Browser

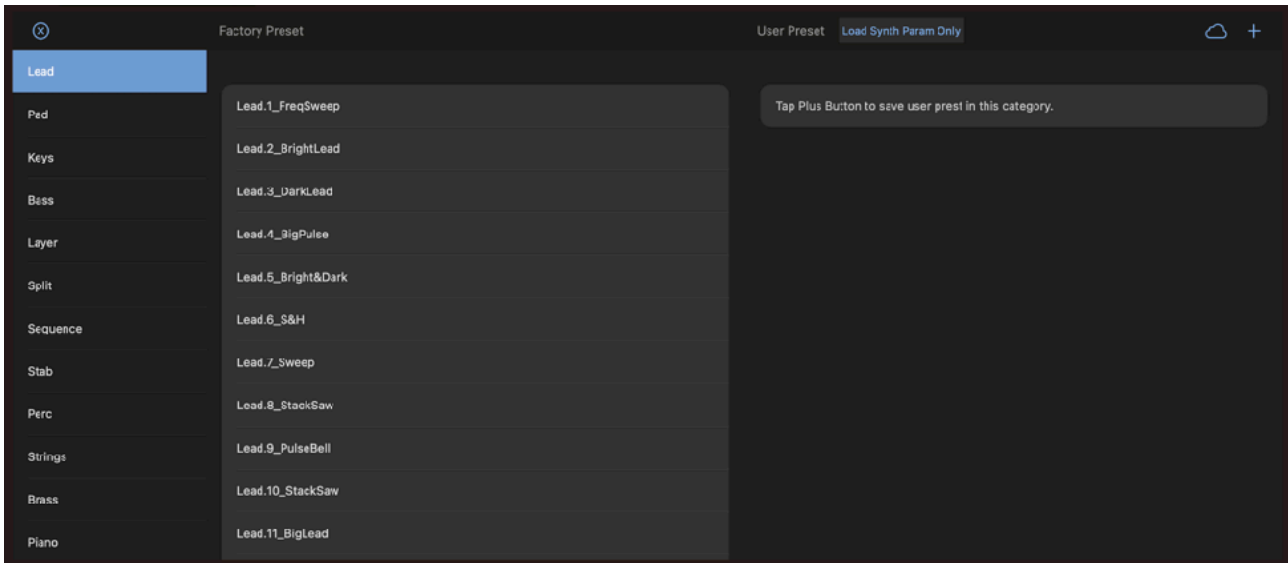

Load Factory Preset

Select a category from a list in the side bar. Tap on the name of the preset in Factory Preset Section to load.

Load User Preset

Select a category from a list in the side bar. Tap on the name of the preset in User Preset Section to load. If “Load Synth Param Only” is on, only synth parameters will be loaded. If the option is off, synth param and sequencer data will be loaded.

Delete User Preset

Tap and hold (right click on macOS) on the name of the preset in User Preset Section to show context menu and select Delete.

Save User Preset

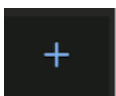

Select a category from a list in the side bar. Tap on plus button to add a user preset.

Backup/Restore User Presets stored in the device



To back up or restore all user presets, tap on the iCloud icon to show export menu.

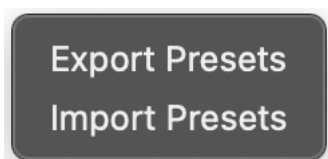

Select Export Presets to back up all of the user presets to iCloud.

Select Import Presets to import saved presets from iCloud.

Close File Browser

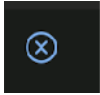

Tap on X icon to close the browser.

CH Preset Browser

Synth factory preset can be loaded to each synth channel individually.

Open CH Preset Browser



Tap on preset name to open file browser.

Load Factory Preset

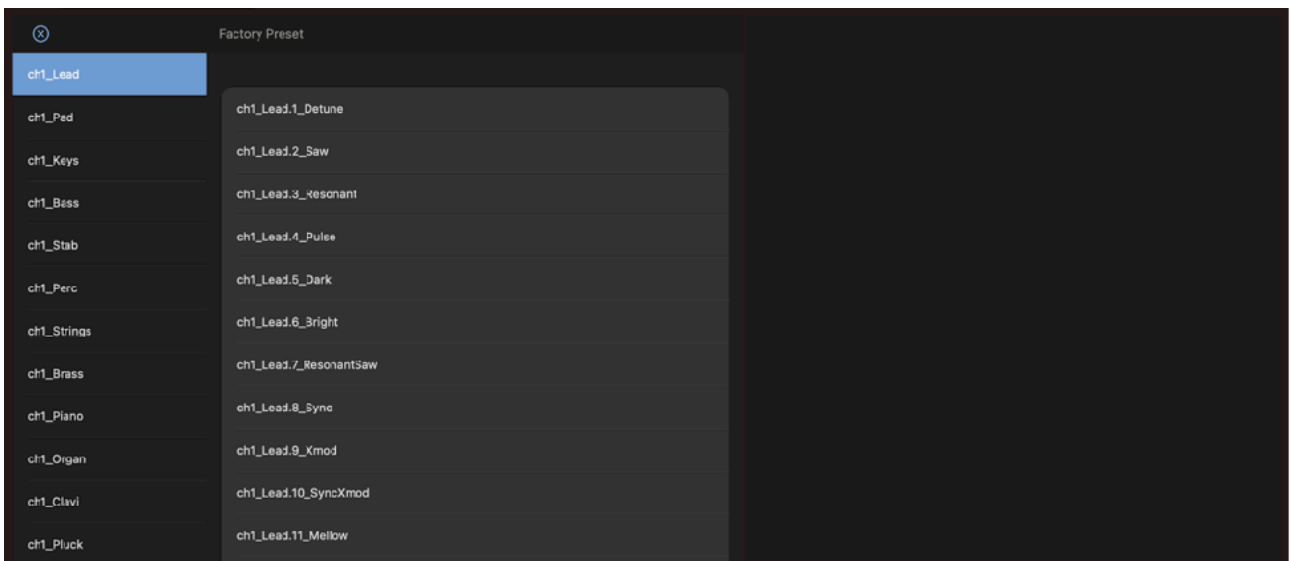

Select a category from a list in the side bar. Tap on the name of the preset in Factory Preset Section to load.

Close File Browser

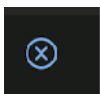

Tap on X icon to close the browser.

Setting Panel

General

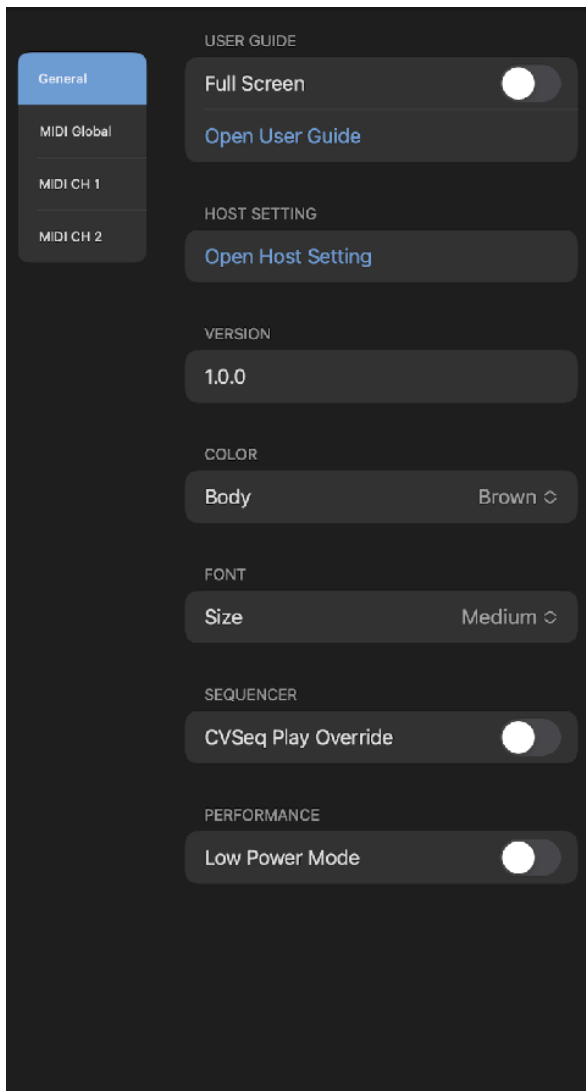

Full Screen

Enable this option to open User Guide in full screen (full window size on macOS).

Open User Guide

Tap this button to open User Guide

Open Host Setting

Tap this button to open Stand Alone Settings

Version

Indicate version number of the installed app.

Color

Select color. Options are black, navy, gray and blown.

Font

Select size of parameter title. Options are small, medium and large.

CVSEQ Play Override

Enable CVSEQ Play override option.

Low Power Mode

Enable low power mode option.

MIDI Global

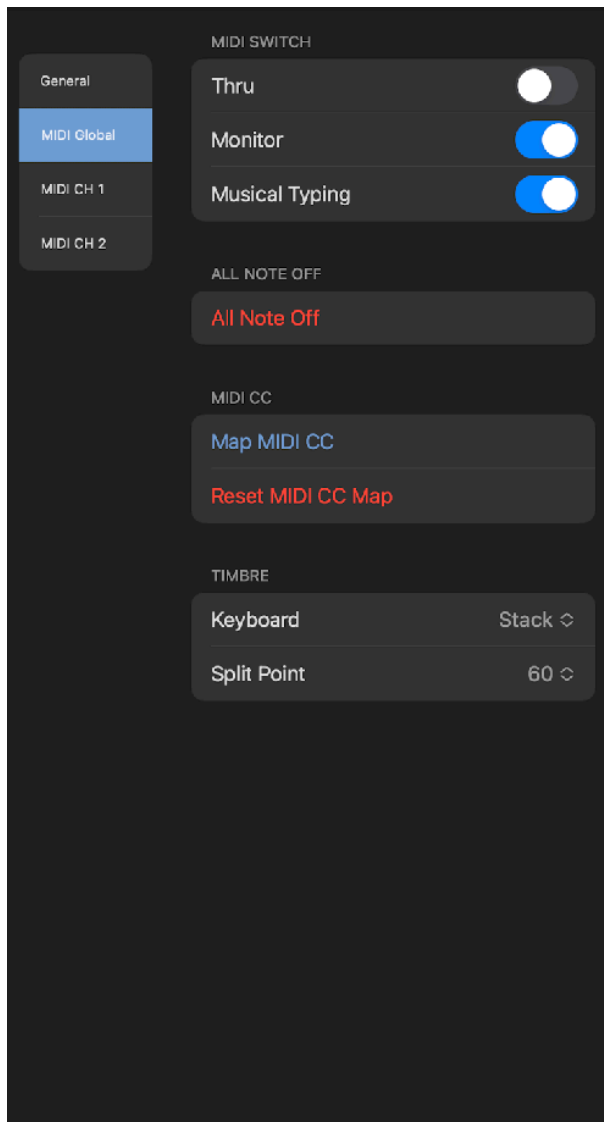

MIDI Thru

When MIDI thru is turned on, MIDI messages received in MIDI input will be send out from MIDI output. This setting is required when connected device's local switch is turned off.

MIDI Monitor

Enable / disable MIDI key input monitoring. Key Range of keyboard and sequencer is automatically adjusted based on the input note.

Musical Typing

Enable / disable computer keyboard to play MIDI notes.

All Notes Off

Send note off message to all notes.

Map MIDI CC

Open or Close Map MIDI CC view.

Reset MIDI CC Map

Remove all MIDI CC Map assignments.

Keyboard

Select Voice Stack to play Synth 1 & 2 as layer. Select Voice Split to play Synth 1 & 2 individually.

Split Point

Select split point as MID note. Default is middle C (C3).

MIDI Synth 1 & 2

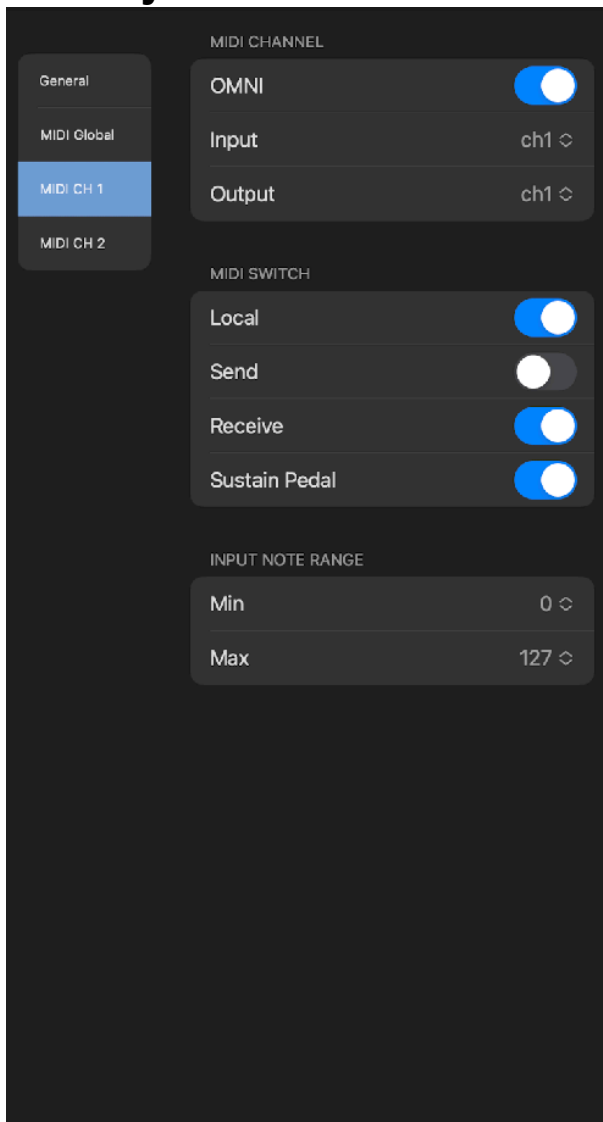

OMNI

Turn this on to connect all channel.

Input

Select input channel

Output

Select output channel

MIDI Local

When sending and receiving MIDI, connected device may send back the MIDI. This causes each notes to play twice. If this problem occurs, turn MIDI Local Switch OFF to disconnect User Interface from the audio engine.

MIDI Send

Enable / disable MIDI output.

MIDI Receive

Enable / disable MIDI input.

Sustain Pedal

Enable / disable to receive Damper Pedal message (MIDI CC #64).

Min

Set min value of MIDI note input.

Max

Set max value of MIDI note input.

Stand Alone Setting

AbletonLink

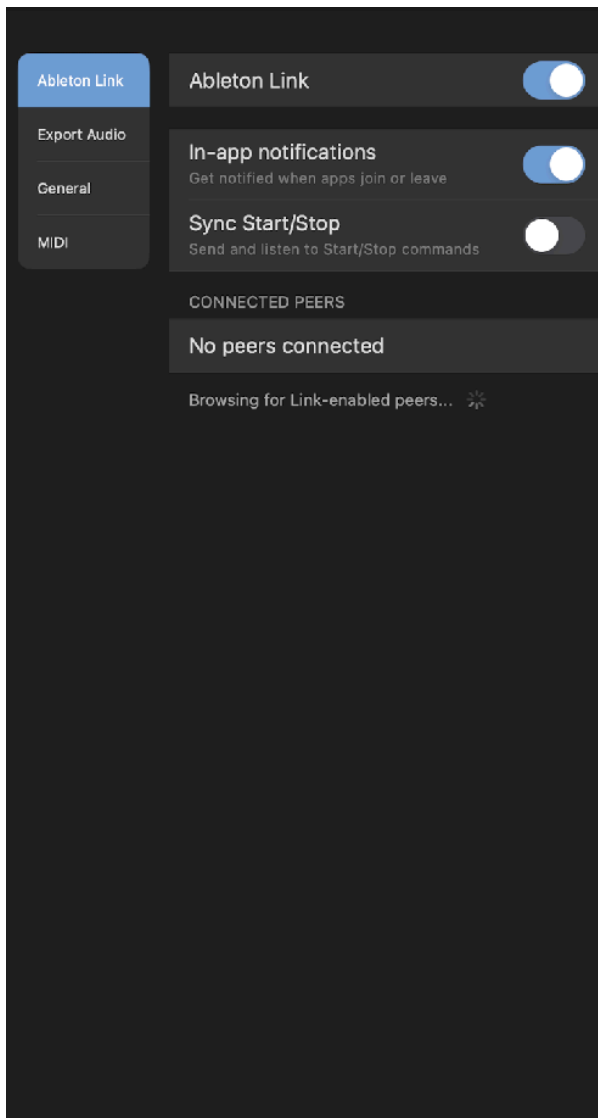

Ableton Link is a new technology that synchronizes beat, phase and tempo of Ableton Live and Link-enabled iOS apps over a wireless network. It lets you play devices together with the freedom of a live band. Anyone can start and stop their part while others keep playing, and anyone can adjust the tempo and the rest will follow. You can use Link to play with several instances of Ableton Live, with Live and iOS apps, or even without Live in your setup: using Link-enabled apps on multiple devices, or multiple apps on the same device.

Ableton Link

Switch on to enable Ableton Link.

In-app notification

Switch on to displays a message when an Ableton Link enabled app is connected.

Sync Start/Stop

Switch on to synchronize start and stop with connected apps.

Connected Apps

Indicate number of currently connected apps.

Ableton Link requires Wireless Local Network Connections. Your device and other Link-enabled devices must be connected to the same local network.

Export Audio

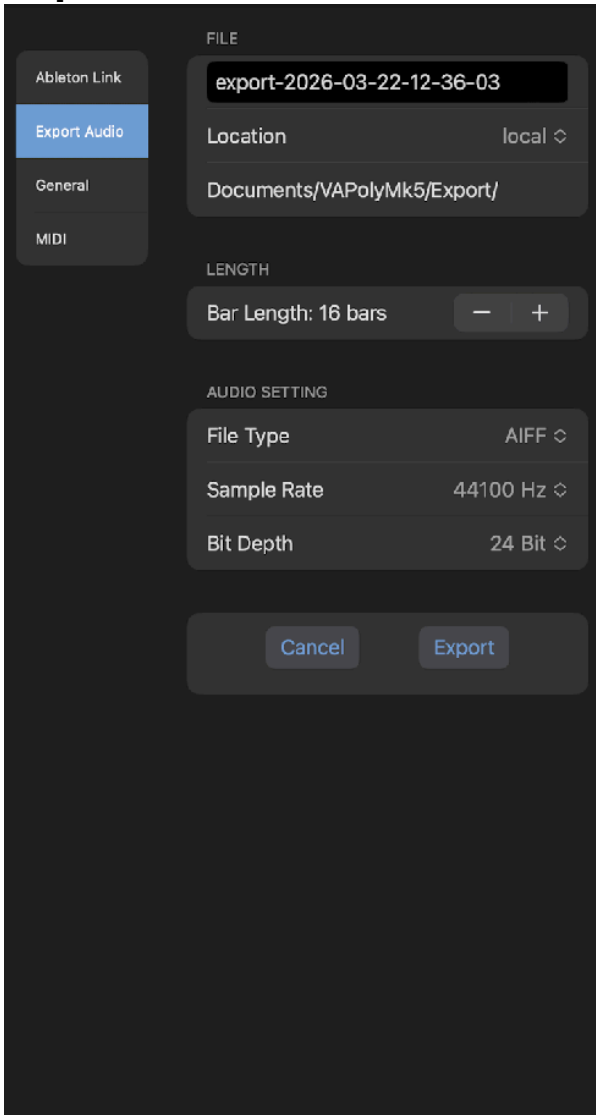

Save As

Specify name of the audio file to export.

Location

Select location for the audio file to be stored. Options are Local or iCloud.

Length (Bars)

Length of the audio to be recorded. Specify the length by number of bars.

File Type

Select file type of the audio file. Options are AIFF, WAV, CAF and ACC.

Sample Rate

Select a sample rate of the audio file. Options are 44.1KHz, 48KHz, 88.2KHz and 96KHz.

Bit Depth

Specify bit depth of the audio file. Options are 16 bit, 24 bit and 32 bit.

Export

Tap export to export audio file.

Cancel

Tap cancel to return to the home page of the setting panel.

General

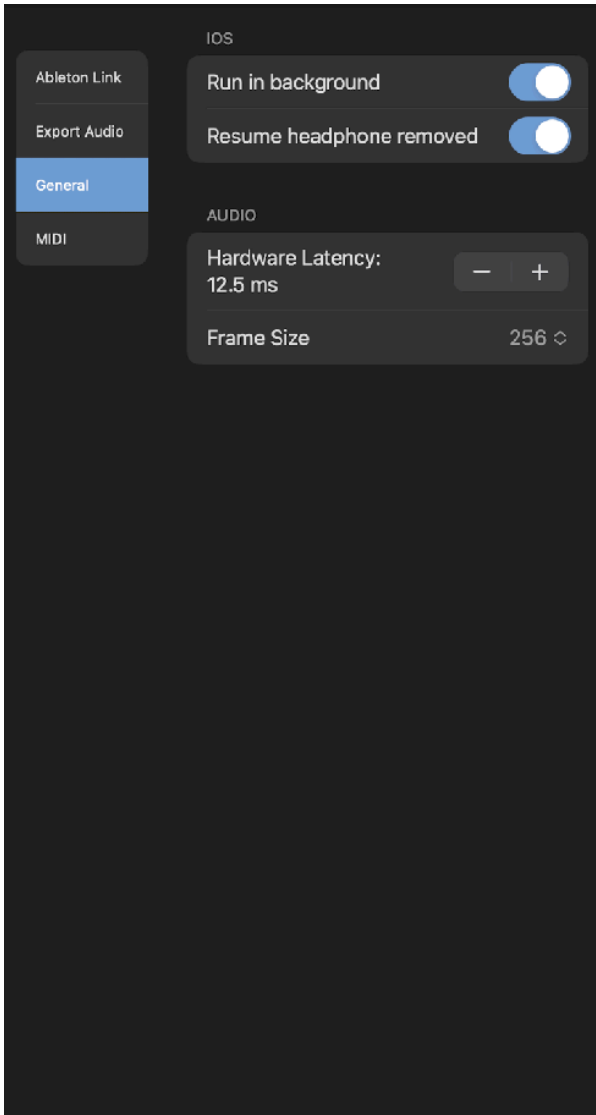

Run in Background

Turn this switch on to allow app to play continuously when the app enters in the background.

Resume Headphone Removed

Turn this switch on to allow app to play continuously when headphone is disconnected.

Hardware Latency

When Ableton Link is enabled, playback is synchronized to the Link-enabled devices. If there is a latency, output signal may not be aligned with the beginning of the each step.

In order to adjust the latency, set time in milliseconds in Hardware Latency. This value is used to compensate the latency of the output signal.

The latency varies on audio Interface and sample rate. Default value is 12.5 millisecond (sample rate is 44.1KHz)

Frame Size

Frame Size (Buffer Size) is a number of samples contained in an audio buffer. Higher frame size increases system performance but increases latency. Lower frame size decrease latency but decreases system performance. If you experience a problem with system performance, set higher frame size to improve the performance. Default setting is 256.

MIDI

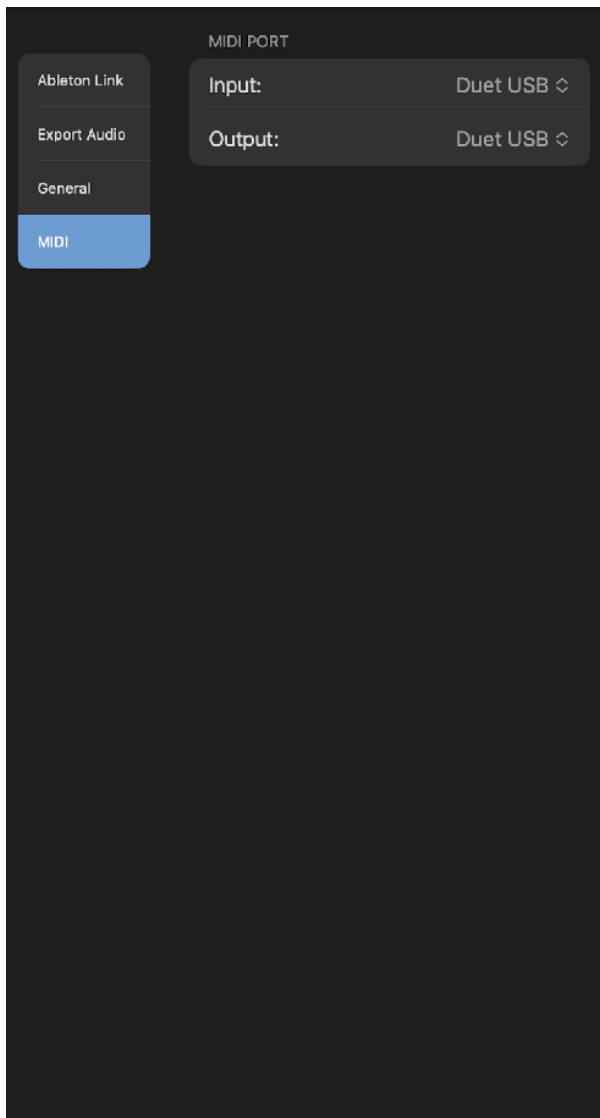

Input

Select MIDI input port

Output

Select MIDI output port

Bluetooth (BLE) MIDI

Central

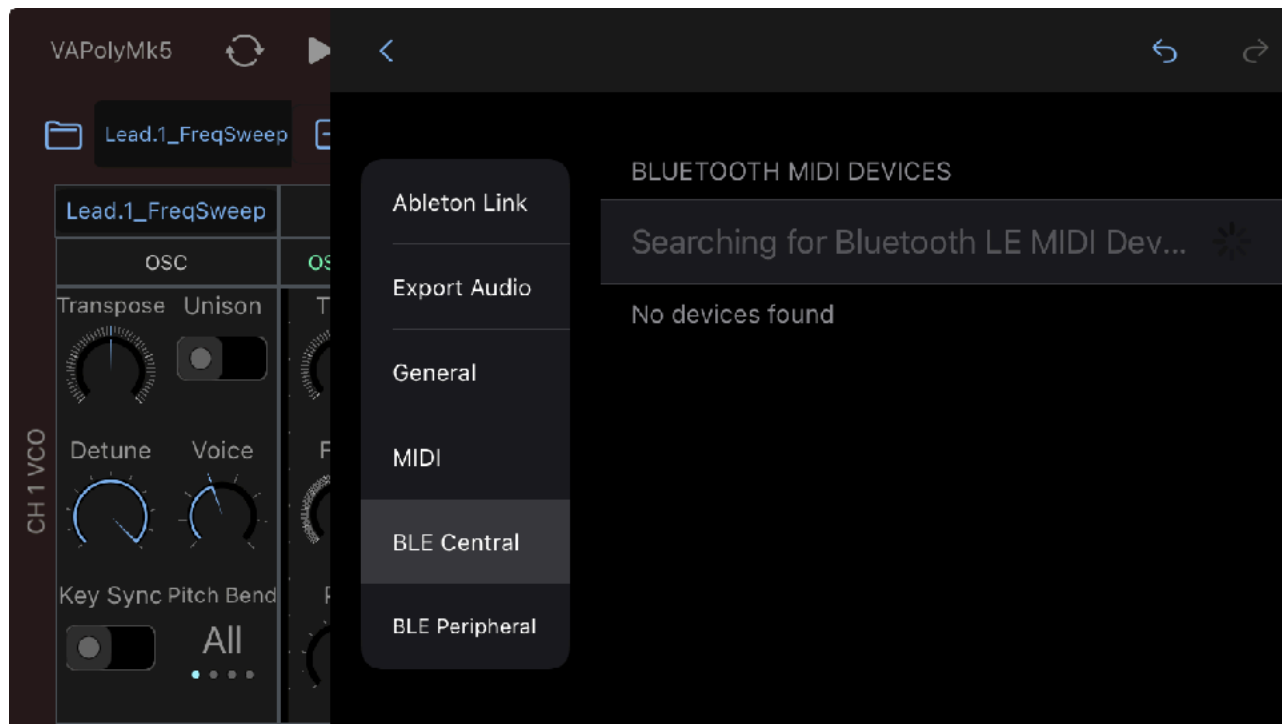

Open Bluetooth MIDI Central, which list available bluetooth devices. Select a name to connect to the device.

Peripheral

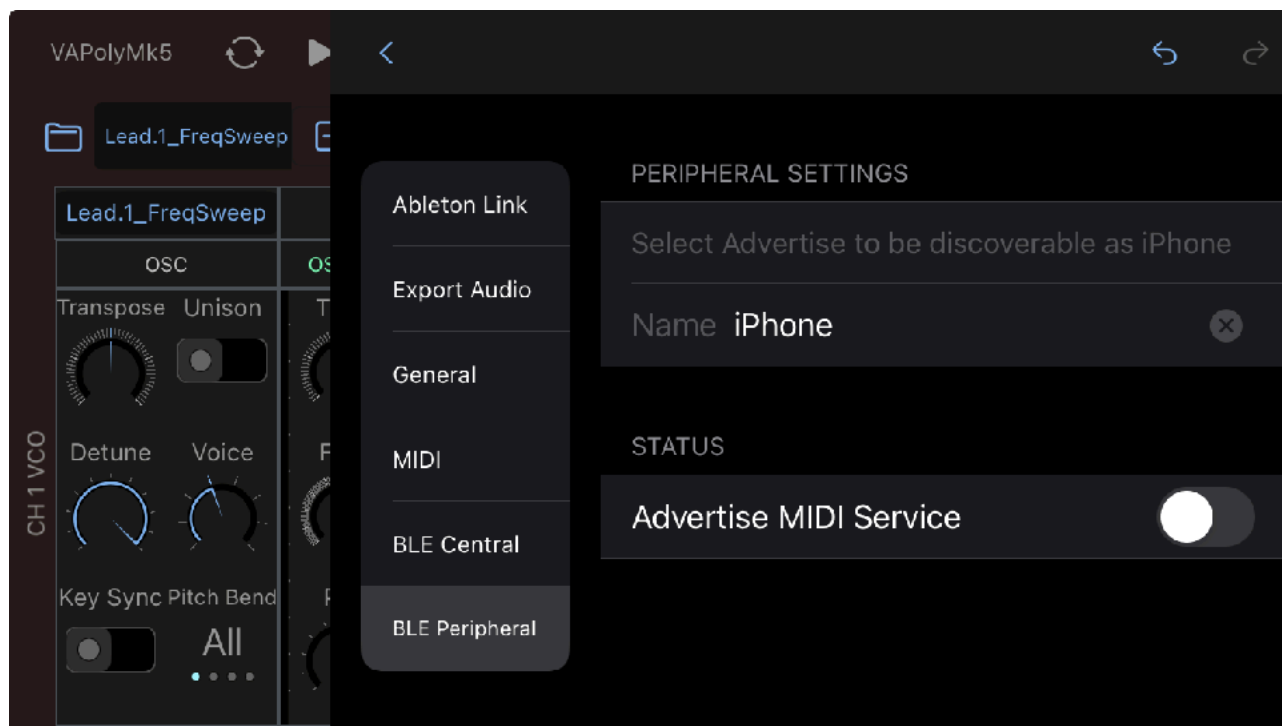

Open Bluetooth MIDI Peripheral. Turn Advertise MIDI Service switch on to makes the device to be discoverable from the other Bluetooth MIDI devices.

Export Audio

Prepare for exporting audio

1. Stop playback

Make sure the playback is stopped.

2. Select the first clip to play

Open clip editor and select a clip which should be played at first.

3. Turn off metronome

Make sure that metronome is turned off.

Adjust export settings

1. Save As

Type in file name if necessary.

2. Length

Set total length of the recordings by number of bars. This length should include the length of the delay or reverb tail.

3. Location

Select location to save the file. Options are local and iCloud.

4. File Type

Select a file type. Options for linear PCM format are AIFF, WAV or CAF. For compressed audio file, choose AAC. If the exported audio file is going to be edited in a different application, it is recommended to choose linear PCM format.

5. Sample Rate

Select sample rate. Options are 44.1KHz, 48KHz, 88.2KHz and 96KHz.

6. Bit Depth

Select bit depth. Options are 16 bit, 24 bit and 32 bit. Higher number results in better quality. If the exported file is going to be used in a different application, make sure that the which bit depth of the selected file type is supported by the application. (* 32 bit may not be supported in some applications).

Export Audio File

Tap export button to generate audio file and save the file in the specified location. When exporting the file is completed, browser can be open to audition the exported file.

Map MIDI CC

Tap “Map MIDI CC” in “MIDI Global” of the setting panel to show MIDI CC Map View. Use “Synth” button in tool bar to select a synth section or effects to map MIDI CC. Tap “Hide MIDI CC” in “MIDI Global” of setting panel to close MIDI CC Map View.

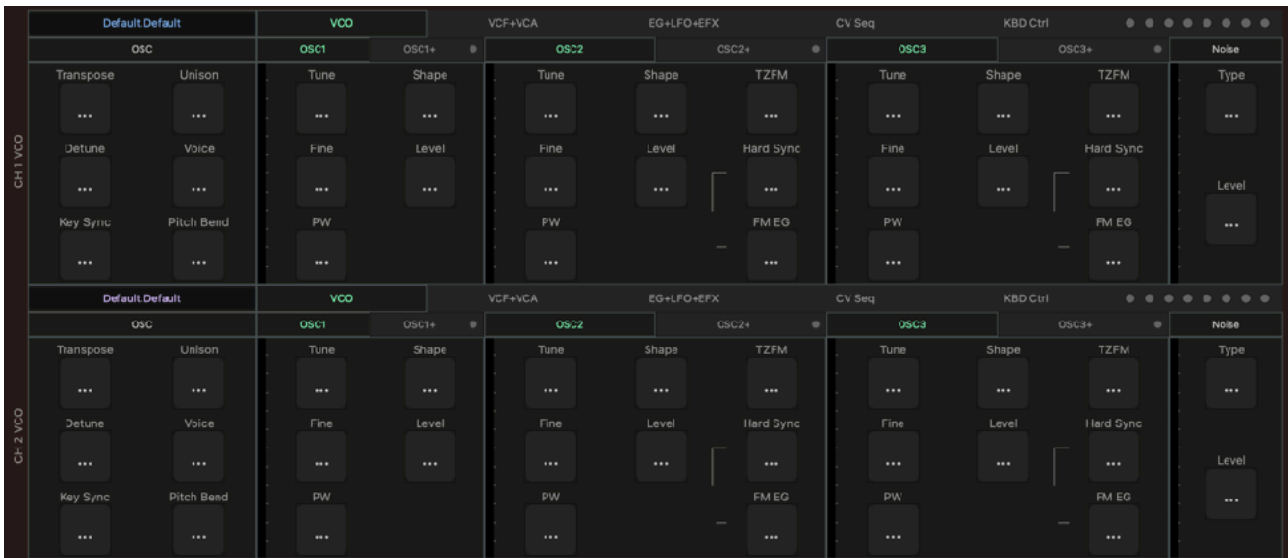

To make a MIDI CC (Continuous Controller) assignment, Tap a button then turn a knob on MIDI controller. The first MIDI CC number detected will be assigned to the parameter.

When CC is assigned, the button shows the CC number.

To cancel the assignment or to remove the mapping, tap the button.

To remove all assignments, select “Rest MIDI CC Map” in MIDI Global of the setting panel.

All the MIDI CC assignments are restored when app is launched in the next time.

Override Automation

When a parameter is controlled by MIDI controller, it is not possible to automatically override automation. To override, turn off automation switch of the parameter or turn the dial of the parameter on screen that will stop the automation and the parameter can be controlled freely by MIDI controller.

MIDI Program Change

Program Change is received as following.

Factory: Bank (CC#0) = 0

Plugin: Bank (CC#0) = 1

Preset Number = Sub (CC#32) * 128 + Program [0, 127]

Presets stored in iCloud Drive can't be selected by the MIDI program change.

Use External MIDI Keyboard with Stand Alone

1. Open host setting
2. Select MIDI from side bar menu. Set input MIDI port and output MIDI port.
3. Close host setting
4. Select MIDI Synth1 from side bar menu. Make sure “Receive” switch is turned on. Adjust channel and note range.
5. To stop hanging note, select MIDI Global from side bar menu, Tap on “All Note Off”.

Use MIDI Foot Pedal

CC#11 and CC#64 are supported for MIDI Foot Pedal. Targets of Expression can be selected in KBD Control Routing Panel. Sustain switch can be used to sustain currently played note.

Undo / Redo



1. Tap Undo / Redo button. Tap Undo to undo previous operation. Tap Redo to redo previous undo operation.

* Some operation such as play, stop or record are excluded from undo / redo operation.

* On macOS, turn on “Musical Typing” to enable keyboard shortcut, command + z for undo and shift + command + z for redo.

macOS

Stand Alone on macOS supports menu bar, keyboard shortcuts, context menu and touch bar. AUv3 plug-in on macOS supports keyboard shortcuts and context menu.

Menu Bar



Application

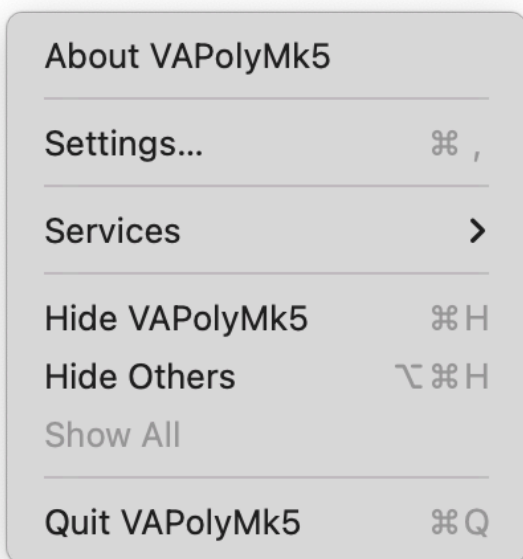

Open a window to display version information.

Open Preference window.

Quit this application.

File

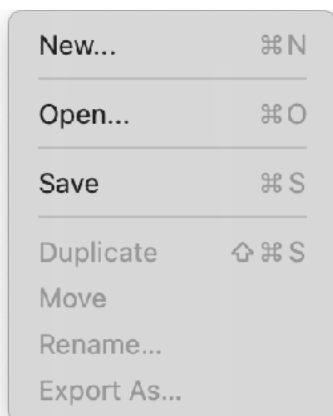

Reset all parameters and sequence data.

Open a preset from iCloud drive.

Save a preset to iCloud drive.

Edit

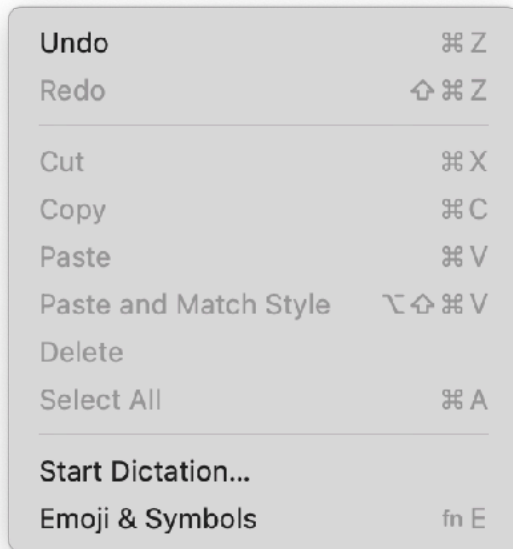

Edit Commands are enabled when typing text.

View

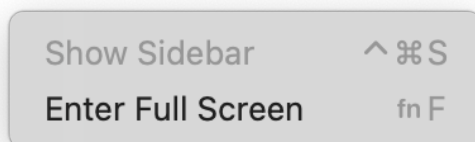

Enable/disable full screen mode.

Export

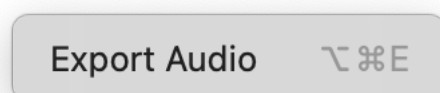

Open Export Audio Page in Setting Panel.

Window

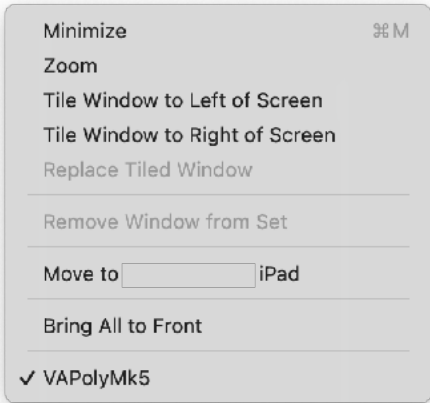

Help

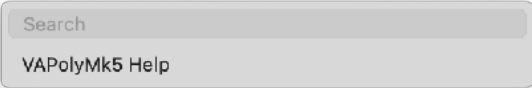

Preference

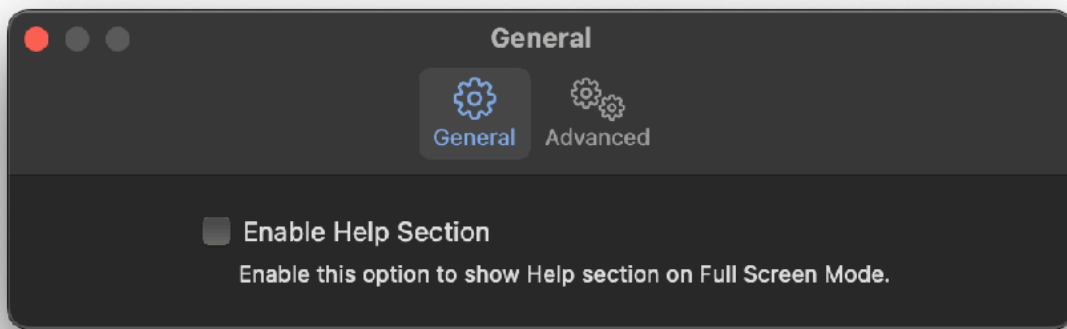

Enable Help Section

Enable this option to show Help Section on Full Screen Mode.

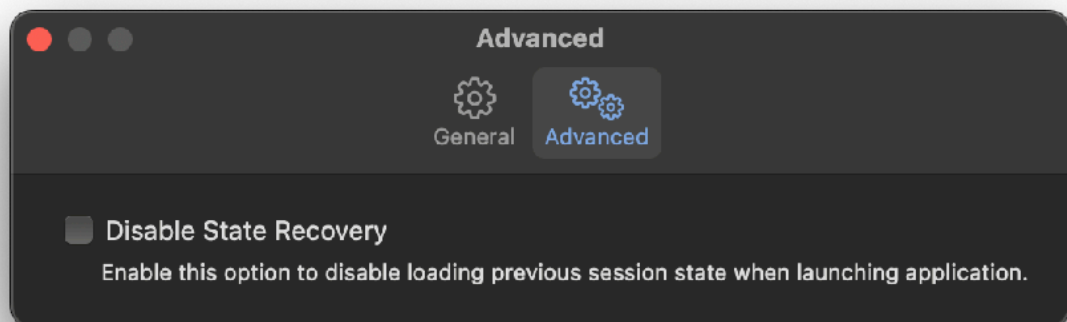

Disable State Recovery

When application is launched, state of the previous session is automatically loaded by default. Check this option to disable state recovery, so the application always start in default state.

Touch Bar (MacBook Pro)

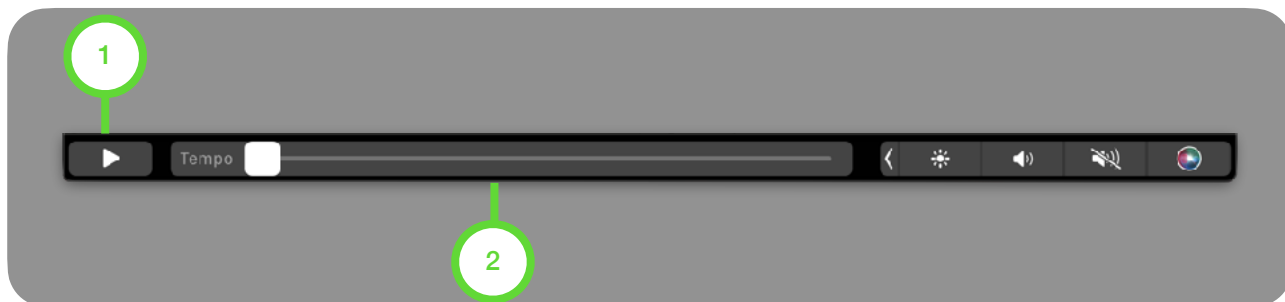

1. Play / Stop

Tap to play / stop sequencer

2. Tempo

Adjust tempo. Range of the slider is from 20 BPM to 240 BPM.

Use Computer Keyboard as MIDI Keyboard

Enable Musical Typing option in setting.

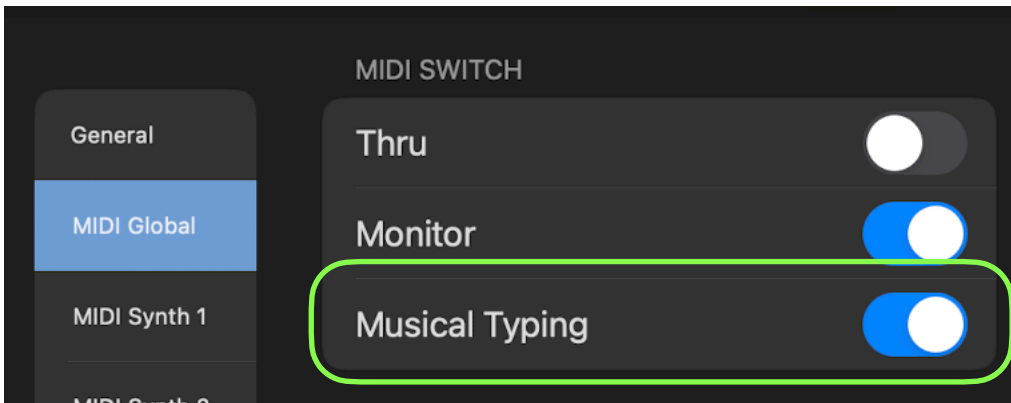

Keys are mapped as shown in the figure below.

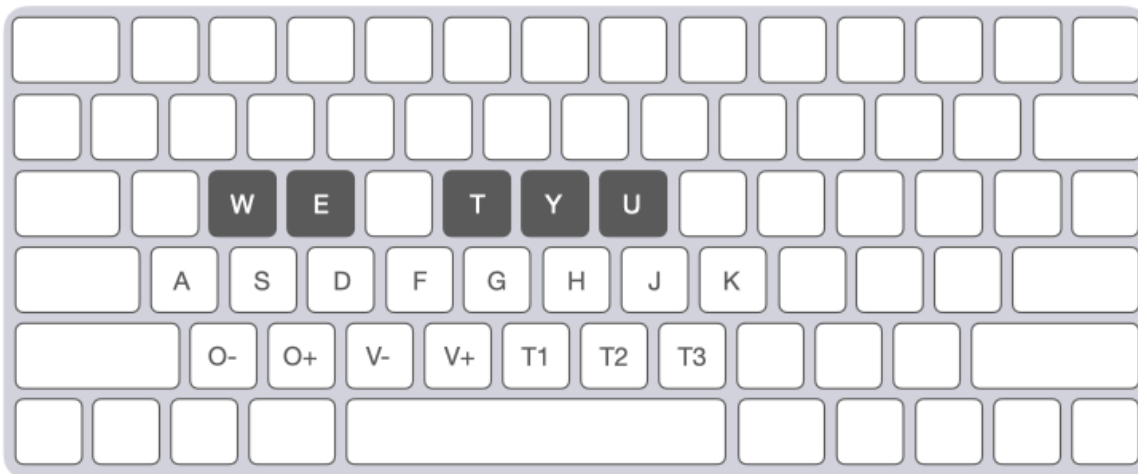

Change Octave

[O-] Press Z key to select one octave below.
[O+] Press X key to select one octave above.

Change Velocity

[V-] Press C key to decrease velocity.
[V+] Press V key to increase velocity.

Set Timbral

[T1] Press B key to select Layer.
[T2] Press N key to select Synth1.
[T3] Press M key to select Synth2.

Keyboard Shortcut

Command	Key	AUv3	Note
New	Command-N	N/A	
Open	Command-O	N/A	
Save	Command-S	N/A	
Undo	Command-Z	✓	
Redo	Shift-Command-Z	✓	
Cut	Command-X	✓	Available for Text Input
Copy	Command-C	?	
Paste	Command-V	?	
Delete	Command-Delete	?	
Select All	Command-A	?	
Enter/Exit Full Screen	fn-F	N/A	
Play/Stop	Space	?	
Change Focus	Tab	?	
List Up	Arrow-Up	?	
List Down	Arrow-Down	?	
List Select	Enter	?	

? : (AUv3) Availability is depends on the host application, which can disable these functions.

* Some of the keyboard shortcut will be available in the future version update.

AUv3 on Apple Garage Band (Mac)

Load Plug-in

1. Launch GarageBand.
2. Choose a project dialogue window appears. Select a project and click on Choose.

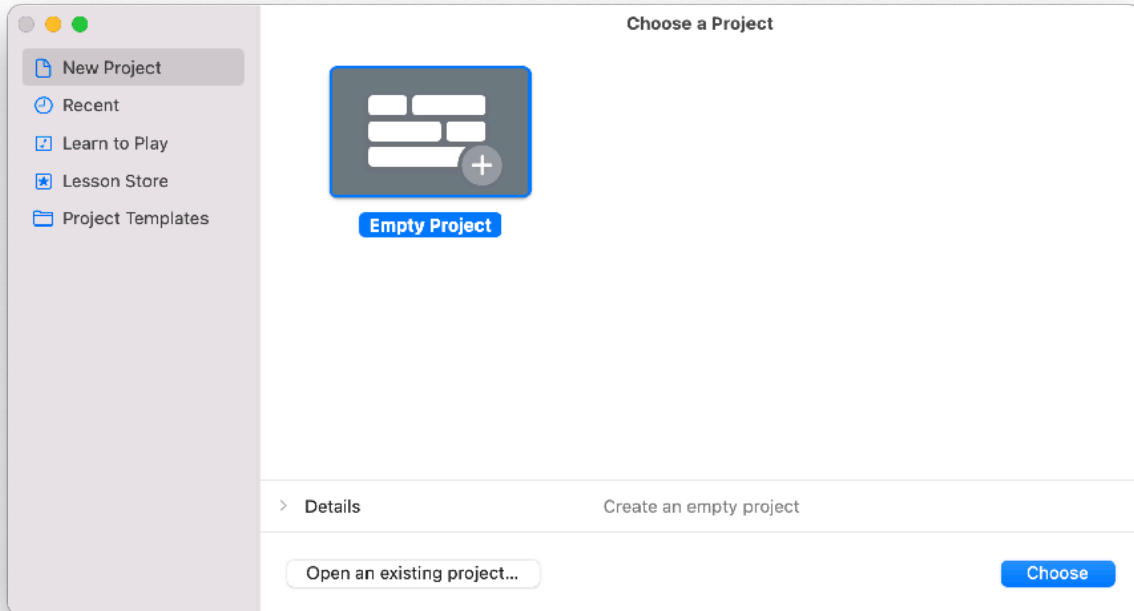

3. Choose a track type dialogue appears. Select Software Instrument and click Create.

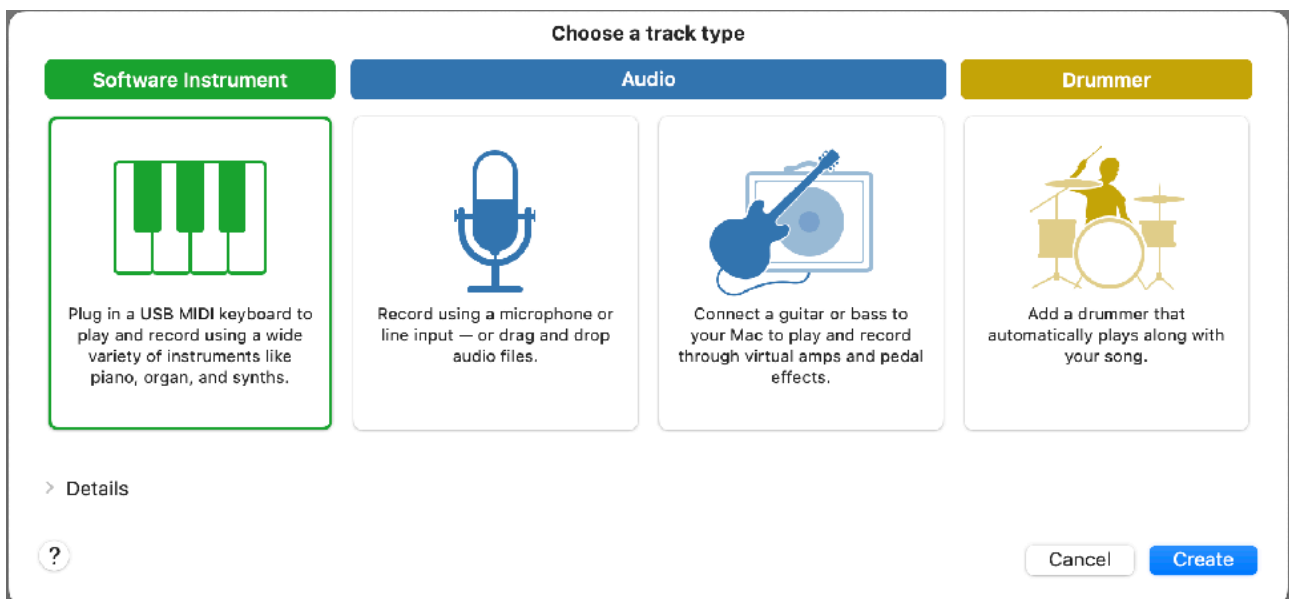

4. Click Plug-ins in Track Section.

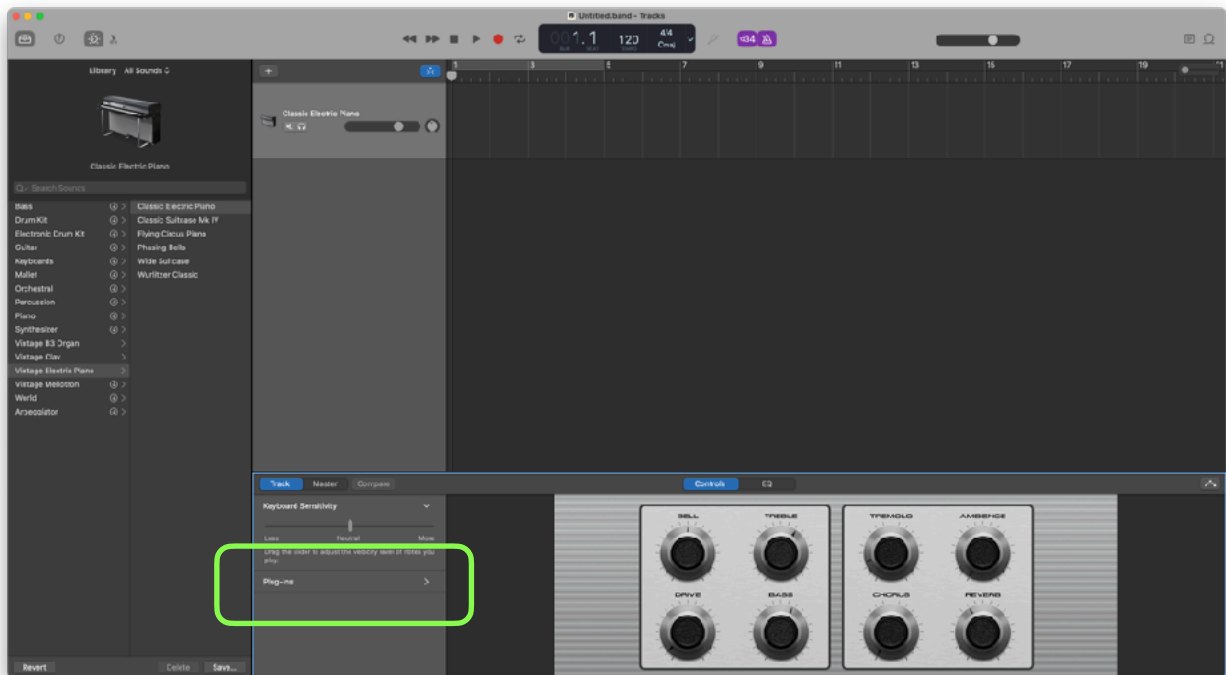

5. Click arrows at the right side of the blue button “E-Piano”.

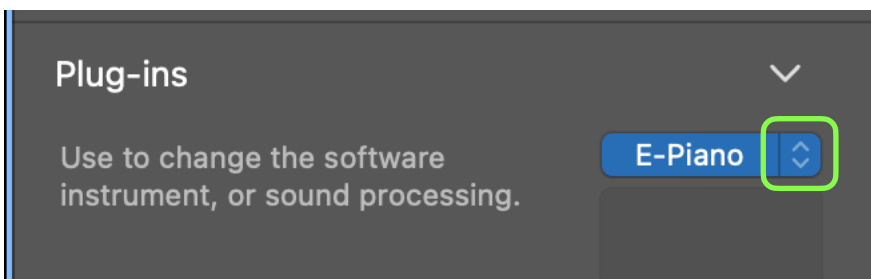

6. Select AU Instruments > RTMS > VAPolyMk5

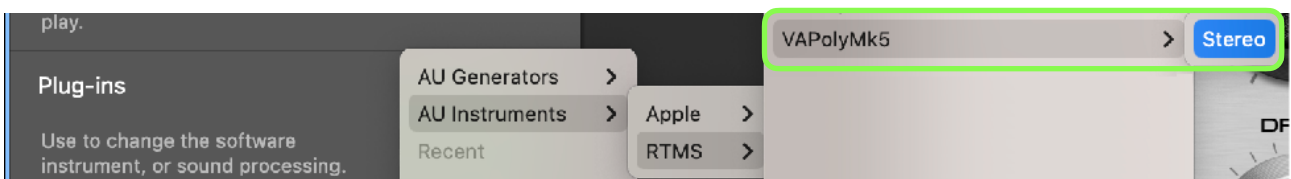

7. If plug-in window doesn't displayed. Tap blue button.

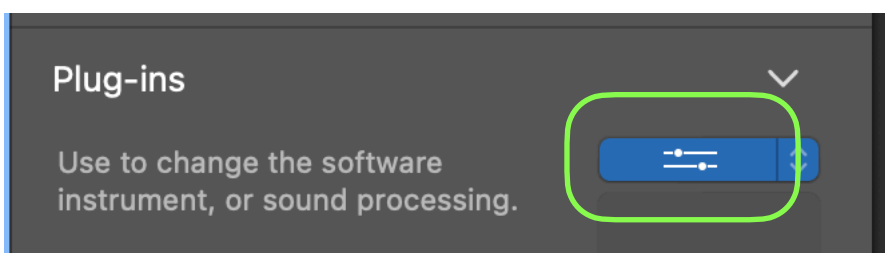

Activate Plug-In

After loading VAPolyMk5 or opening a project file, DSP engine of VAPolyMk5 may not be running.

In order to start the DSP engine, please do one of the followings.

- Press Play button on GarageBand.
- Play MIDI notes from GarageBand.

To play midi note by computer keyboard, select “Window > Show Musical Typing” from menu bar of the Garage Band. While the Musical Typing window is displayed, type A for note C.

Offline Renering

To start Offline Rendering on Apple Garage Band, select Cycle Range and select “Share > Export Song to Disk” from menu bar of the Garage Band. Selected Cycle Range will be rendered.

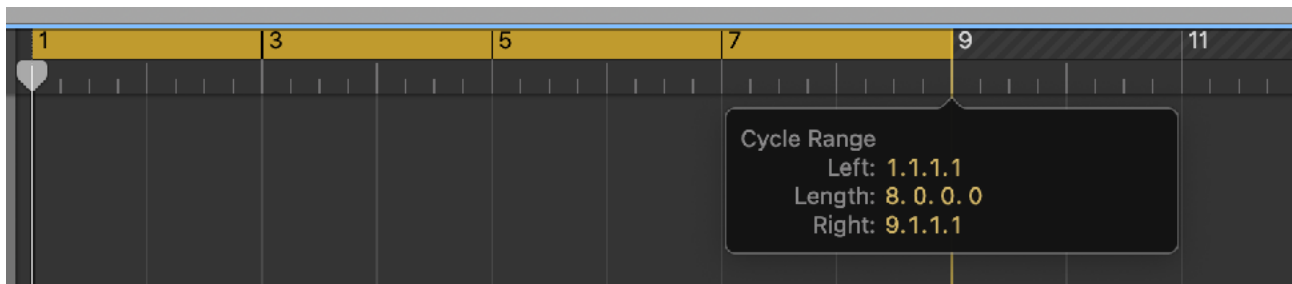

The followings are a few tips for offline rendering on Apple Garage Band.

- Make sure to save your project before performing offline rendering.
- Audition before initiating offline rendering. In order to perform offline rendering, DSP engine of VAPolyMk5 needs to be running. Please press play on GarageBand and make sure that DSP engine is running.
- If you are using clips, add an empty clip at the end and set the length to INF. Garage Band will stop rendering when audio level is dropped to inaudible level. This helps to record tail of the delay or reverb effect.

Known Limitations

- DSP Engine doesn't start until a user presses play button or play MIDI notes on GarageBand.
- Touch Bar shows blanc screen when showing button menu or context menu.
- GarageBand doesn't record MIDI notes from keyboards or sequencer of the VAPolyMk5 plugin.

AUv3 on Apple Garage Band (iOS)

Load Plug-in

1. Launch Garage Band
2. Create a new song

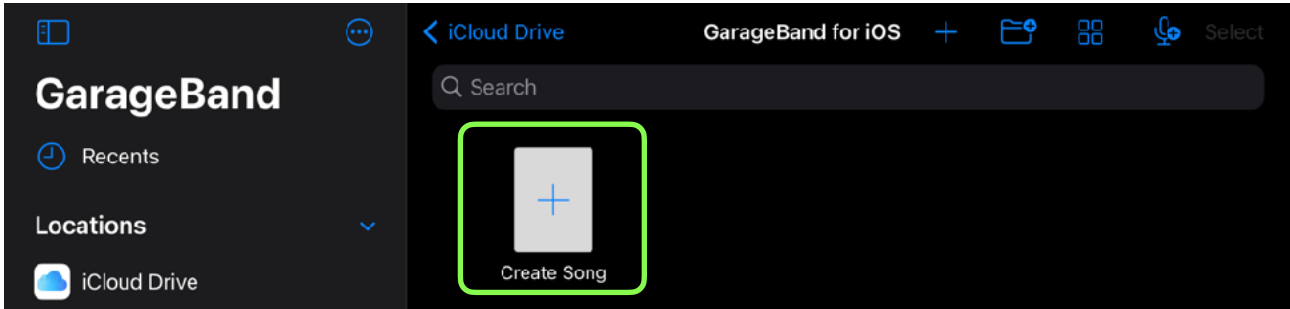

3. Select External > Audio Unit Extension

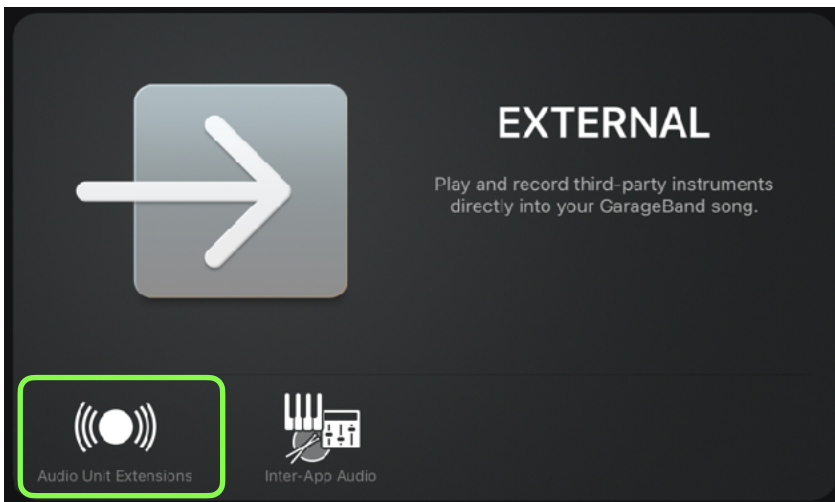

4. Select VAPolyMk5

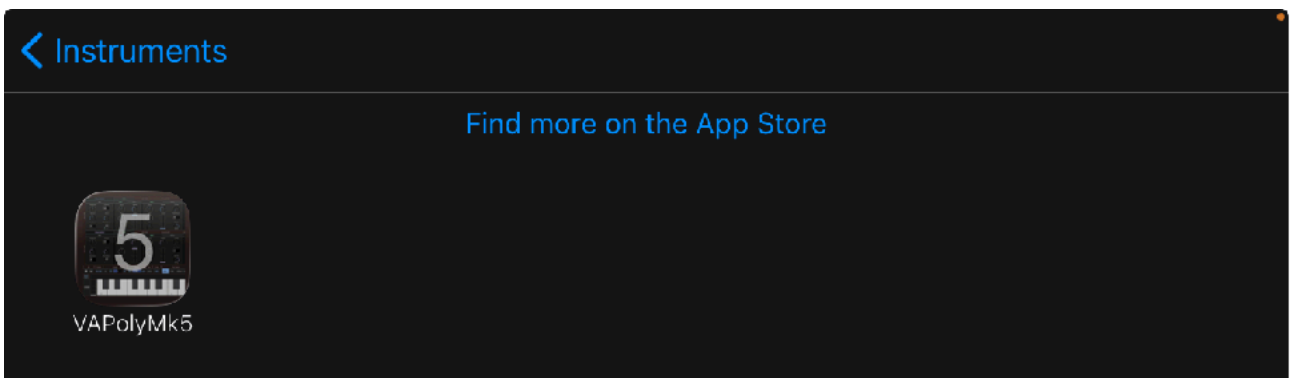

Change Plug-in Window Size

Tap arrow icon to resize the plug-in window.

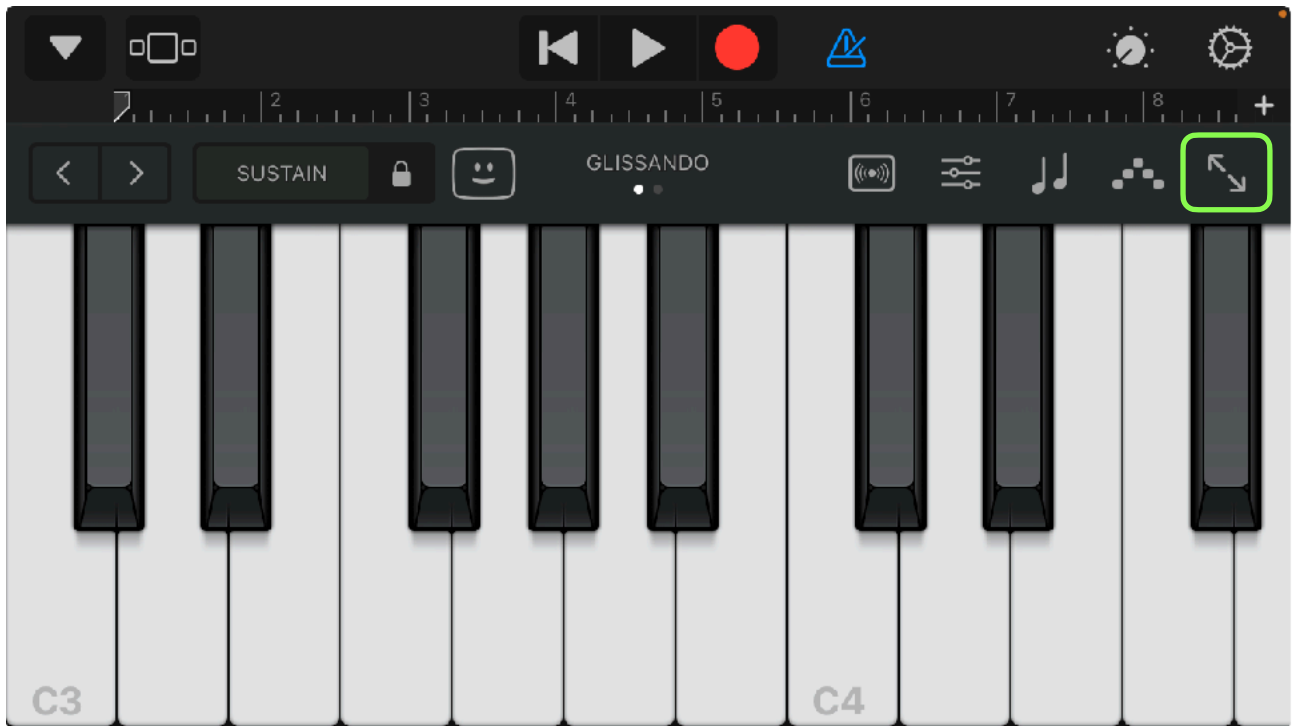

Record Notes

Tap record button and play keyboard.

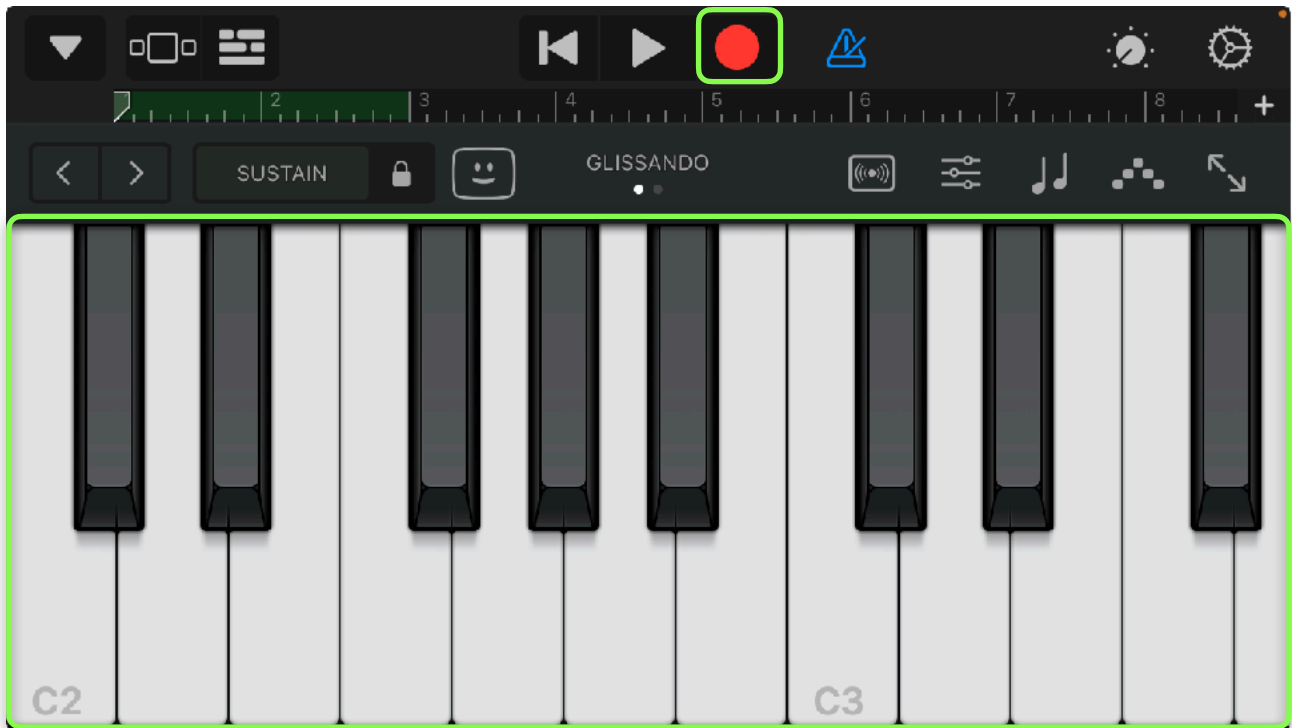

Edit Notes

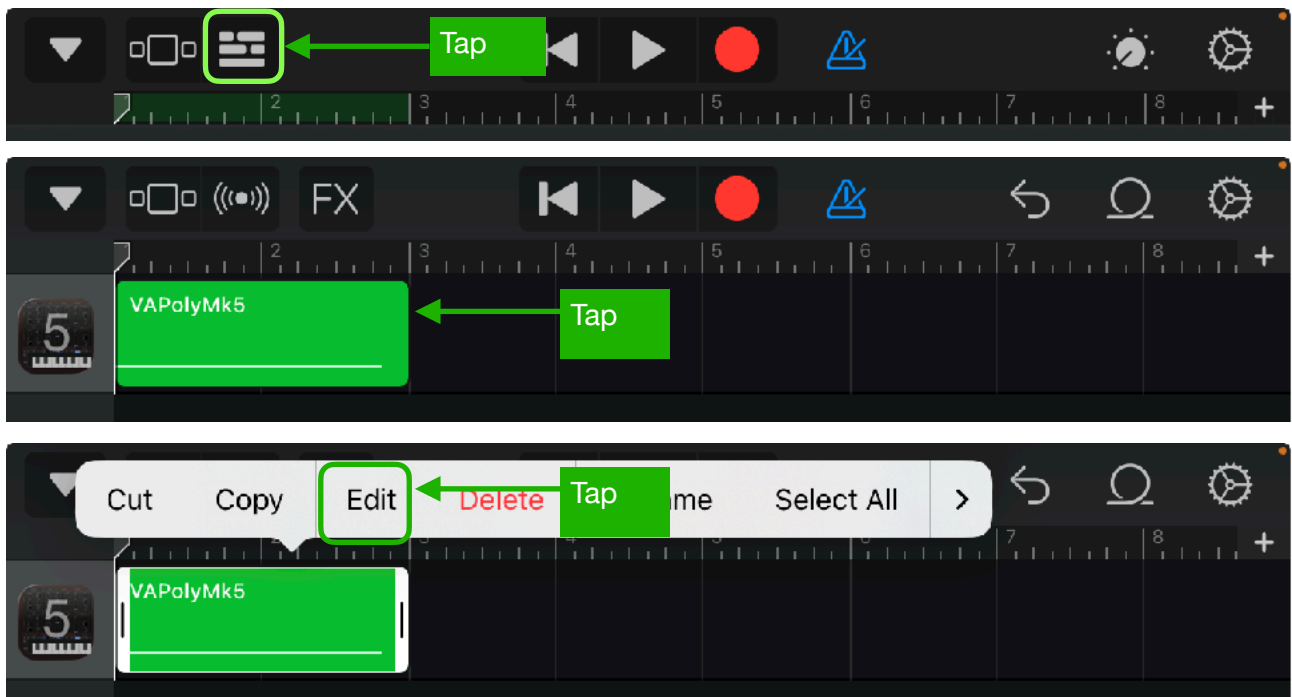

Select Edit from menu and edit notes. Tap “Done” to close the window.

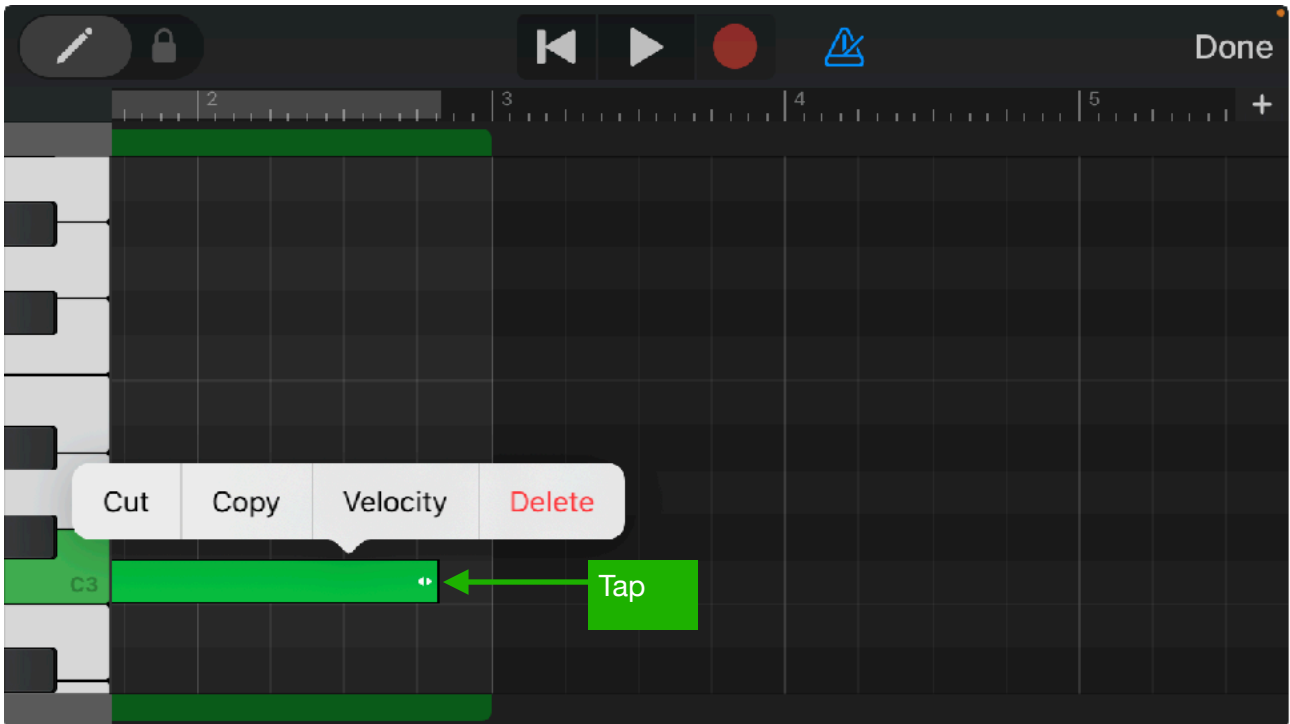

Save Project

Tap document icon to save the song.

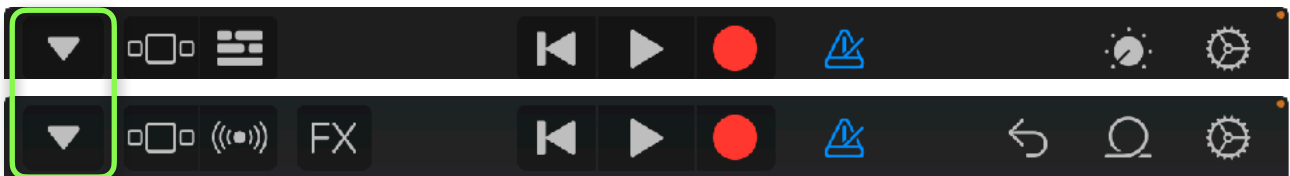

Host Sync

Tap Host Sync button to sync transport and tempo to host application.

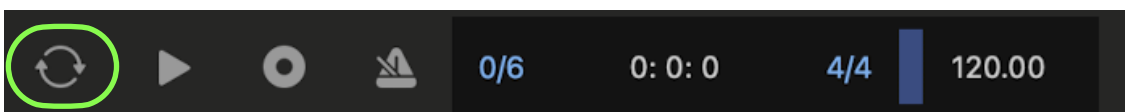

To disable transport sync, tap and hold sync button and select “Disable Transport Sync” from menu.

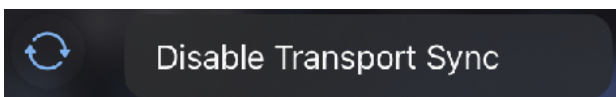

System Interruptions (iOS)

It is important to aware that system may interrupt playback in the following situations. Please make sure to test and make a plan to handle the situations.

1. Incoming calls or activating Siri

When receiving an incoming call or when activating Siri, it interrupts playback and send App to background. In order to avoid it occurs, turn off the followings in the Setting App.

- Do Not Disturb > Do Not Disturb > turn on.
- Siri & Search > Listen for “Hey Siri” > turn off.
- Siri & Search > Press Home for “Siri” > turn off.

2. Connecting or disconnecting a headphone

Headphone output has own DAC⁴ and own sample rate. The sample rate may be different form the sample rate of the audio engine. What will happens when connecting or disconnecting a headphone depends on the sample rates.

If the sample rates are same, playback continues when headphone is connected. When headphone is unplugged, playback will stop. You can change this behavior by turn Resume when headphone is unplugged on in Settings.

If sample rates are different, when connecting headphone or when disconnecting headphone stops playback and system will re-configure audio engine for the new sample rate.

The sample rate of the audio engine is set by an application or an audio interface. For example, when connecting an iOS device to Mac using a cable that came with your device, Inter Device Audio and MIDI on macOS uses 44.1KHz but Quicktime player app on macOS uses 48KHz.

If you are planning to connecting or disconnecting headphone for monitoring during playback, please make sure to test and learn what will occurs.

3. Changing sample rate setting

As described above, if sample rate of the audio engine is changed for any reasons, playback stops.

4. Media Reset

Under rare circumstances, the system terminates and restarts its media services daemon. When it occurs playback stops.

5. Pressing the Home button or sending App to background

When app is sent to background by pressing home button, showing notification center or any other reasons, playback stops. You can change this behavior by turn Run in Background on in Settings.

Additional Settings

Followings are other settings in the Settings App which you may want to adjusted.

- Display & Brightness > Auto-Lock > set to Never
- Sounds > turn off all system sound
- Notifications > Show Previews > set to Never
- Home Screen & Dock > Multitasking > Gestures > turn off

If you have installed apps that may send you a notifications or may interrupt playback, make sure to adjust settings of the apps to disable the functions.

If you are using Ableton Link, make sure that Local Network in Privacy is turned on. If you are using Bluetooth MIDI, make sure that Bluetooth in Privacy is turned on.

⁴ Digital to Analog Converter

Specification

Synthesizer

- Bitimbral Polyphonic Synthesizer

Oscillator 1, 2 & 3

- Continuously variable wave shape (triangle, sawtooth, square)
- Pulse width for square
- Tuning +/- 24 semitones
- Fine tuning +/- 50 cents
- Frequency Modulation (Exponential)
- Pulse Width Modulation
- Cross Modulation (Through Zero FM, oscillator 1 to oscillator 2 & 3)
- Hard Sync (oscillator 1 to oscillator 2 & 3)
- Transpose: +/- 24 semi tones.
- Master Tune: +/- 50 cents
- Key Sync: On/Off
- Transpose: +/- 24 semi tones.
- Detune: +1 cent

Noise Generator

- Noise: Pink or White

Filter

- Low pass filter: -12 dB per octave, -24 dB per octave
- High pass filter: -12 dB per octave
- Frequency modulation: ADSR, LFO, Key Follow

Amplifier

- Envelope: ADSR / Gate
- Amplitude modulation: LFO
- Pan modulation: LFO

LFO

- Wave shape: sine, saw, down saw, square, triangle, random
- Frequency Range: From 0.04Hz to 42.2Hz
- Amplitude modulation: ADSR envelope
- Polyphonic (LFO2)
- Frequency Modulation: ADSR envelope. (LFO2)

ADSR Envelope

- Attack time: From 1ms to 6 sec
- Decay time: From 1ms to 10 sec
- Sustain level: From 0 to 100%
- Release time: From 1ms to 10 sec
- Delay time: From 0ms to 10 sec
- Key Follow: From 100% to 25% (envelope length)

Arpeggio

- Type: Up, Down, Up&Down. Random
- Frequency: From 1 Hz to 20 Hz

Portamento (Glide)

- Time: From 10 ms to 10 second

Step Sequencer (Analog Style)

- 8 Steps
- Sample & Hold

- Clock Frequency: From 1 Hz to 20 Hz
- Note sequencer: 1
- Modulation sequencer: 3

Morph

- Stereo Width: From 0 to 100 %
- Mix: From 0 to 100 %
- LFO: From -100% to 100 %

Ring Modulator

- Attack Time: From 3 ms to 530 ms
- Decay Time: From 7 ms to 4.50 Sec
- Speed: From 0.2 Hz to 220.0 Hz
- Depth: From 0 to 100 %
- Mod: From 0 to 100 %

Effects

- Delay, Chorus, Flanger, Reverb, EQ and Compressor

-

Controllers

- Modulation Wheel, Pitch Bend Wheel, Ribbon Control

Sequencer (Piano Roll)

- Steps: 16 steps per bar
- Loop Length: from 1 bar to 16 bars
- Clip: 8 clips
- Tempo: from 20 BPM to 999 BPM
- Host Sync: On and Off

Delay

Delay Time	Range from 20ms to 1200ms
Feedback	Range from 0% to 100%
Highpass Filter	Range from 20Hz to 500Hz
Lowpass Filter	Range from 1000Hz to 20000Hz
LFO Frequency	Range from 0.01Hz to 10Hz
LFO Intensity	Range from 0.0 to 1.0 (from 0ms to +/- 10ms)
Effect Switch	ON or OFF
Sync Switch	ON or OFF
Frequency Range	From 0Hz to 22.05KHz (effect)

Chorus / Flanger

Delay Time	Range from 1ms to 40ms (chorus), from 1ms to 13ms / 20ms (flanger)
Feedback	Range from 0% to 100% (flanger)
Highpass Filter	Range from 20Hz to 500Hz
Lowpass Filter	Range from 1000Hz to 20000Hz
LFO Frequency	Range from 0.01Hz to 10Hz
LFO Intensity	Range from 0.0 to 1.0 Chorus: from 0ms to +/- 1ms Flanger: from 0ms to 12ms / 19ms / 39ms
Effect Switch	ON or OFF
Sync Switch	ON or OFF
Effect Selector	Chorus or Flanger
Frequency Range	From 0Hz to 22.05KHz (effect)

Reverb

Input lowpass filter	Range from 1KHz to 20KHz
Input high-pass filter	Range from 20Hz to 500Hz
LFO Frequency	Range from 0.01Hz to 10Hz
LFO Intensity	Range from 0.0 to 1.0
Pre Delay	Range from 1ms to 100ms
Size	Range from 0% to 100%
Auto Size Mode	ON or OFF
Decay	Range from 0% to 100%

Damp	Range from 0% to 100%
Output Lowpass Filter	Range from 1KHz to 20KHz
Early/Late Mix	Range from 0% to 100%
Tempo Sync	ON or OFF
Effect Switch	ON or OFF

Equalizer

Low Shelving	Frequency Range	Range from 21Hz to 1092Hz
	Gain	Range from -INF to +12dB
	High Pass Filter response	12dB / Oct
Mid Peak / Notch	Frequency Range	Range from 151Hz to 2389Hz
	Gain	Range from -14dB to +14dB
	Bandwidth	1 octave
High Shelving	Frequency Range	Range from 296Hz to 21096Hz
	Gain	Range from -INF to +12dB
	Low Pass Filter response	12dB / Oct

Compressor

Input Gain	Range from -20dB to 20dB
Input High Pass Frequency	Range from 20Hz to 185Hz
Threshold	Range from -40dB to 0dB
Makeup Gain	Range from 0dB to 20dB
Ratio	2, 4, 10
Attack	0.01ms, 0.1ms, 0.3ms, 1ms, 3ms, 10ms, 30ms
Release	0.1s, 0.3s, 0.6s, 1.2s, Auto
Dry / Wet	Range from 0% to 100%

*Appearance and specification of the product are subject to change without notice.

Release Notes

What's new in version 1.0

- Initial release

What's new in version 1.0.1

- Fixed a problem that frequency for envelope of CV Sequencer Mod Signal is calculated incorrectly.

What's new in version 1.0.2

- Version 1.0.2 contains bug fixes and improvements.

What's new in version 1.0.3

- Version 1.0.3 contains bug fixes and improvements.

What's new in version 1.0.4

- Version 1.0.4 contains bug fixes and improvements.

What's new in version 1.0.5

- Fixed a problem that portamento time can't be changed correctly.

What's new in version 1.0.6

- Version 1.0.6 contains bug fixes and improvements.
- Made a change to apply glissando before fine-tune, detune and vibrato.