

# VAPolyLead

## Polyphonic Synthesizer



## User Guide

Version 1.0

# Table of Contents

Introduction	14
Privacy Settings	14
Main Features	14
System Requirements	14
Use as Stand Alone	15
Use as AudioUnit Extension (AUv3)	15
Factory Preset	15
User Preset	15
State Recovery	15
About MIDI Latency	15
Maximum Number of Touches	15
User Interface	16
Tool Bar	18
Controller	20
OSC1	20
OSC2	20
OSC3	20
VCF	20
VCA	20
Effect	21
OSC1+	22
OSC2+	22
OSC3+	22
HPF	22
EG	22
LFO1	24
LFO2	24
LFO3	24
LFO4	24

LFO5 (Mod Wheel)	25
Mod Wheel	25
Step Sequencer	26
Modulation	27
Sample & Hold	28
Delay	29
Chorus / Flanger	29
Reverb	29
EQ and Mixer	29
Compressor	30
Master Output	30
Chorus / Flanger	31
Reverb	31
Mixer	31
Compressor	31
Key Pad	33
Keyboard	34
Visualizer	35
Sequencer (Piano Roll)	37
Clip Editor	38
Piano Roll Editor	39
Parameter Automation Editor	40
Synthesizer	41
Block diagram	41
Control Signal & MIDI Flow	41
Oscillators	43
Tune	43
Fine	43
PW (Pulse Width)	43
Shape	43

Level	43
FM Amount	43
FM LFO	43
FM Env	43
PWM Amount	44
PWM LFO	44
PWM Env	44
VCF (Low Pass Filter & High Pass Filter)	45
Cutoff	45
Resonance	45
Env Mod	45
LFO Mod	45
Key Follow	45
Key Track Gain	45
Noise	45
VCA (Amplifier)	46
Volume	46
Pan	46
AM	46
Pan Mod	46
AM LFO	46
Pan LFO	46
EFX Send	47
Delay Send	47
C/F Send	47
Reverb Send	47
EG (ADSR Envelope Generator)	48
Attack	48
Decay	48
Sustain	48

Release	48
Velocity	48
Key Follow	48
LFO	49
Tune	49
Shape	49
Delay	49
Tempo Sync	49
Key Sync (Key Re-Trigger)	49
Level	49
Mod Wheel Target	49
Vibrato	49
Tremolo	49
LFO5	49
Output Mixer	50
Delay Level	50
C/F Level	50
Reverb Level	50
Master Output	50
Volume	50
Pan	50
Mute	50
Step Sequencer	51
Step Switch	51
Slide Switch	51
Gate	51
CV	51
Play	52
Mode	52
Rate	52

Tempo Sync	52
Quantize	52
Steps	52
Gate	52
KBD Root	52
Root Key	52
Octave Range	52
Clock Division	53
Mod Amount	53
Target	53
Mod Attack	53
Mod Release	53
Sync	53
Hold	54
LFO1/LFO2	54
Pink/White	54
Sync with Transport Control	55
Effects	56
Delay	56
Signal Flow	56
Delay Time	56
Regeneration	56
Modulation	56
Chorus / Flanger	57
Signal Flow	57
Input Signal Level	57
Effect Type	57
Modulation Speed	57
Modulation Width	57
LFO Shape	57

Stereo Width	57
Regeneration	57
Filters	58
Reverb	59
Signal Flow	59
Input Filter	59
Pre Delay	59
Modulation Speed	59
Modulation Width	59
Size and Decay	59
Damping	59
Output Filter	59
Early / Late Mix	60
Equalizer	61
Low Shelving	61
Mid Peak / Notch	61
High Shelving	61
Compressor	62
Overview	62
Threshold and Ratio	62
Attack and Release	63
Side Chain High Pass Filter	65
Makeup Gain	65
Gain Reduction Meter	65
Input Gain	65
Dry / Wet	65
Peak Limiter	66
Key Pad	67
Select Keyboard	67
Select Octave	67

Select Pitch Shift	67
Select Preset Type	67
Select Preset Bank	68
Select Top Panel	68
Select Mid Panel	68
Enable Play Switch for Step Sequencer	68
Ribbon Controller	68
Keyboard	69
Select Keyboard	69
Select Key Range	69
Use Modulation Wheel	69
Use Pitch Wheel	69
Set Velocity	70
Use Key Hold	70
Scroll Keyboard	70
Ribbon Controller	70
Assignable Controllers	71
Sequencer (Piano Roll)	72
Clip Editor	73
Load Clip	73
Play/Stop Clip	73
Edit Piano Roll	73
Add edit button	73
Set Loop Mode	73
Auto Select Editor	73
Piano Roll Editor	74
Select Time Range and Loop Length	74
Select Note Range	74
Add Note	74
Delete Note	74

Scale Menu	74
Edit Menu	74
Chromatic Scale	75
Heptatonic Scale	75
Root Key	75
Set Length	76
Quantize	76
Set Velocity	76
Copy	76
Paste	76
Delete	76
Velocity Editor	77
Parameter Automation Editor	78
Play Sequence	79
1. Set host sync	79
2. Set tempo	79
3. Set loop	79
4. Set swing	79
5. Set metronome switch	80
6. Play	80
Record Sequence	80
1. Set recording mode	80
2. Play sequence	80
3. Record notes	80
4. Record parameters automation	80
5. Stop recording	80
Preset	81
File Menu	81
New...	81
Open...	81

Save	81
Preset Browser	82
Load Factory Preset	82
Load User Preset	82
Delete User Preset	82
Save User Preset	82
Backup/Restore User Presets stored in the device	82
Close File Browser	83
Setting Panel	84
General	84
Full Screen	84
Open User Guide	84
Open Host Setting	84
Version	84
Color	84
Font Size	84
Show Piano Roll	84
CVSEQ Play Override	84
Voice Count	84
MIDI Global	85
MIDI Thru	85
MIDI Monitor	85
Musical Typing	85
All Notes Off	85
Map MIDI CC	85
Reset MIDI CC Map	85
MIDI Synth	86
OMNI	86
Input	86
Output	86

MIDI Local	86
MIDI Send	86
MIDI Receive	86
Sustain Pedal	86
Min	86
Max	86
Stand Alone Setting	87
AbletonLink	87
Ableton Link	87
In-app notification	87
Sync Start/Stop	87
Connected Apps	87
Export Audio	88
Save As	88
Location	88
Length (Bars)	88
File Type	88
Sample Rate	88
Bit Depth	88
Export	88
Cancel	88
General	89
Run in Background	89
Resume Headphone Removed	89
Hardware Latency	89
Frame Size	89
MIDI	90
Input	90
Output	90
Bluetooth (BLE) MIDI	91

Central	91
Peripheral	91
Export Audio	92
Prepare for exporting audio	92
1. Stop playback	92
2. Select the first clip to play	92
3. Turn off metronome	92
Adjust export settings	92
1. Save As	92
2. Length	92
3. Location	92
4. File Type	92
5. Sample Rate	92
6. Bit Depth	92
Export Audio File	92
Map MIDI CC	93
MIDI Program Change	93
Use External MIDI Keyboard with Stand Alone	94
Use MIDI Foot Pedal	94
Undo / Redo	95
macOS	96
Menu Bar	96
Application	96
File	96
Edit	97
View	97
Export	97
Window	98
Help	98
Preference	99

Enable Help Section	99
Disable State Recovery	99
Touch Bar (MacBook Pro)	100
1. Play / Stop	100
2. Tempo	100
Use Computer Keyboard as MIDI Keyboard	101
Keyboard Shortcut	102
AUv3 on Apple Garage Band (Mac)	103
Load Plug-in	103
Activate Plug-In	105
Offline Renering	105
Known Limitations	105
AUv3 on Apple Garage Band (iOS)	106
Load Plug-in	106
Change Plug-in Window Size	107
Record Notes	108
Edit Notes	108
Save Project	109
Host Sync	109
System Interruptions (iOS)	110
Specification	111
Release Notes	114
What's new in version 1.0	114
What's new in version 1.0.1	114

# Introduction

Thank you for purchasing VAPolyLead. To help you get the most out of this product, please read this manual carefully.

VAPolyLead features 3 channel analog style step sequencer and a VCF modeled on sellen-key filter of iconic monophonic synthesizer in 1970's. This polyphonic synthesizer consists of three oscillators, resonant low pass filter resonant high pass filter, amplifier, ADSR envelope and five LFOs.

VAPolyLead operates as a stand alone or as an AudioUnit Extension (AUv3) for iPhone, iPad and Mac. Stand Alone supports Ableton Link, MIDI and audio file export. Built-in Effects include delay, chorus, flanger, reverb, eq and compressor. Project files can be saved in iCloud Drive, so that the project can be accessed from iPhone, iPad or Mac.

## Privacy Settings

VAPolyLead uses local area network to connect Ableton Link enable devices and it uses bluetooth to connect with bluetooth MIDI keyboard and controllers. When dialogue appears to confirm use of the local network or the bluetooth, tap OK to give a permission to use them. These settings can be edited in Privacy section of the Setting App.

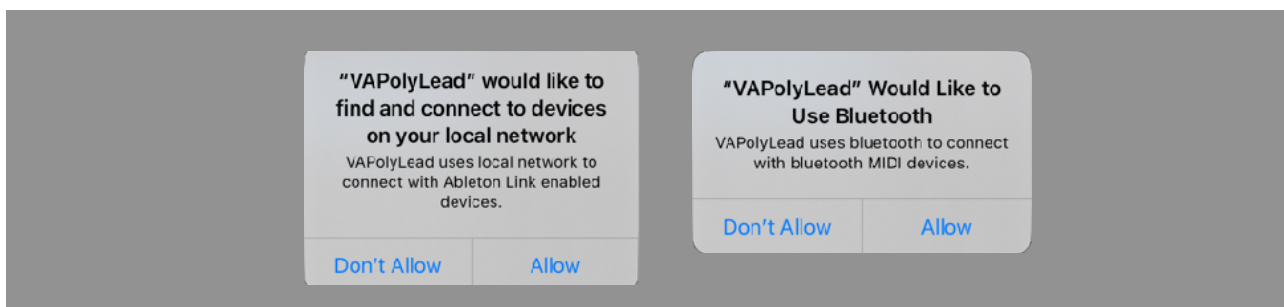

## Main Features

Polyphonic Synthesizer.  
Lowpass filter modeled on -12dB per oct sellen-key filter.  
3 channel analog style step sequencer.

Maximum 8 voice polyphony. it depends on performance of the device it is running.  
Built-in effects and piano roll sequencer.  
Audio Export. Linear PCM format (AIFF, WAV and CAF) and compressed format (AAC)  
Support Audio Unit Extension (AUv3).  
Support MIDI 2.0. Support Foot Pedal.  
Support Ableton Link, Bluetooth MIDI, MIDI In / Out.  
Works on iPhone, iPad and Mac. Support iCloud Drive to share project files between the platforms.

## System Requirements

iOS 17.0 or later  
macOS 14.0 or later  
Devices with Apple Silicon are recommended. A13 Fusion or above is highly recommended.  
AudioUnit Extension (AUv3) requires host application which support AudioUnit Extension.  
AudioUnit Extension is supported by Apple Logic and Apple Garage Band on iOS and macOS.  
For any other DAW, it depends on the application and some of them don't support AudioUnit Extension.

Sound may be distorted if CPU of the device doesn't have enough power. If it happens reduce number of voices.

## **Use as Stand Alone**

Stand Alone mode features Audio Export, Ableton Link, MIDI input / output and bluetooth MIDI. Sequencer can be synced with Ableton Link enabled devices and softwares.

## **Use as AudioUnit Extension (AUv3)**

VAPolyLead supports AudioUnit Extensions. VAPolyLead works with host applications which support AUv3 plug-ins. By enabling host sync mode, VAPolyLead can be synced with tempo and transport state of the host application. VAPolyLead can send and receive MIDI message to/from the host, if the host supports midi in/out of AUv3.

## **Factory Preset**

Factory presets contains only values of parameters of the synth and the effects. It doesn't contain any sequence data. When loading the preset, it will change the value of the parameters but sequence data remains the same.

## **User Preset**

User Preset contains values of the synth parameters and the sequence data. When loading a user preset, value of the synth parameters and the sequence data are both changed.

User Presets can be saved in iCloud Drive or in AUv3 plug-in. User Presets in iCloud Drive can be accessed from iPhone, iPad or Mac. AUv3 Plug-In Preset is stored on the device and saved preset can be accessed from any host application which support AUv3 User Preset.

## **State Recovery**

When VAPolyLead is used as a stand alone, it stores state of the app when the app is terminated. Stored data is recovered when it is launched at the next time. macOS version can disable this feature. The state is stored locally on the device.

## **About MIDI Latency**

Sending or receiving MIDI notes and messages to Software Applications introduces a latency. If you have a problem of latency and DAW or host application has channel delay, adjust the delay time to compensate the latency.

## **Maximum Number of Touches**

Maximum number of touches are varied on devices. Number of notes simultaneously playing on built-in-keyboard are limited to the maximum number of touches.

- \* Apple, Mac and GarageBand are trademarks of Apple Inc., registered in the U.S. and other countries.
- \* Ableton and Link are trademarks of Ableton AG.
- \* All products, companies and standard names are trademarks or registered trademarks of their respective holders.

# User Interface



# macOS

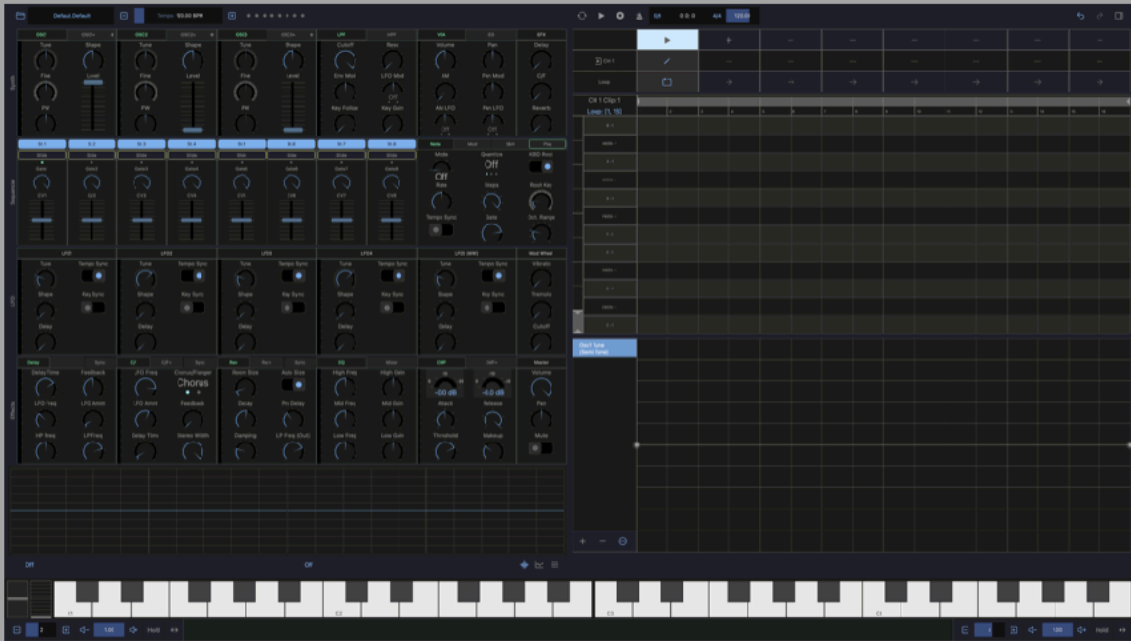

# Tool Bar



## Show Piano Roll Sequencer turned on (Setting Panel)

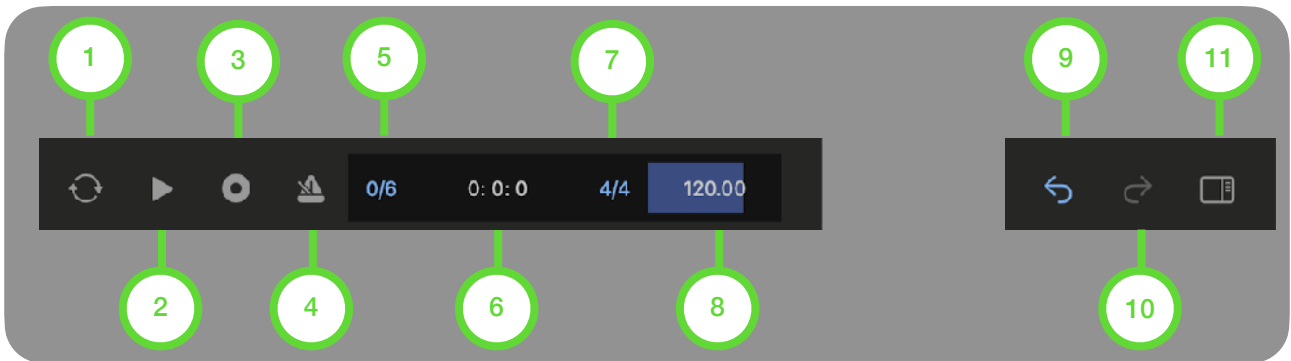

1. Host Sync  
Tap this button to enable / disable host sync. When host sync is enabled, tempo and transport is controlled by the host application.

2. Play/Stop  
Tap this button to play / stop the sequencer.

3. Record  
Tap this button to enable / disable recording mode.

4. Metronome  
Tap this button to enable / disable metronome.

5. Swing  
Tap this button to show Swing menu.



6. Beat Counter  
Indicates current beat time as a format of bar, beat, and sixteenth.

7. Time Signature  
Tap this button to show Time Signature menu.



8. Tempo  
Adjust BPM (Beat Per Minutes).

9. Undo  
10. Redo  
Tap the button to undo / redo.

11. Setting Panel  
Tap this button to open setting panel.

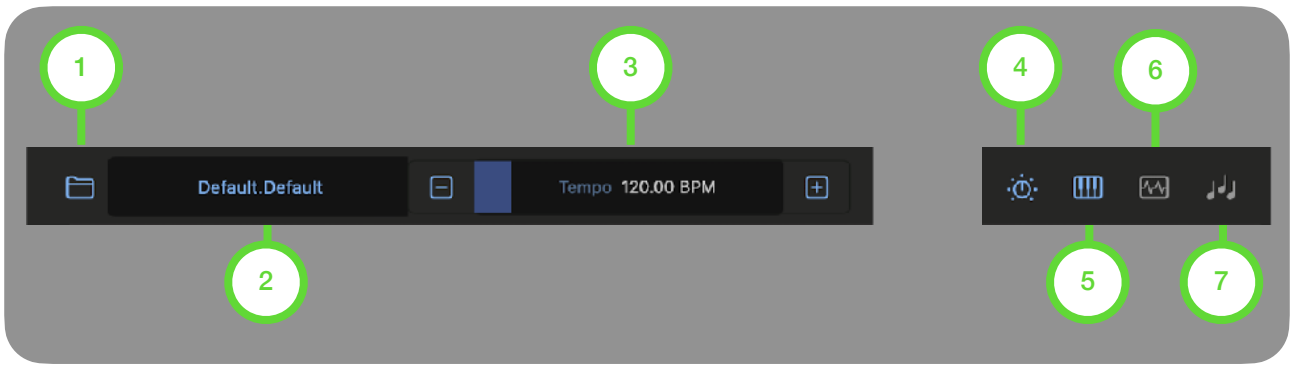

### 1. File

Tap this button to show file menu.

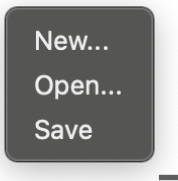

### 2. Preset

Indicates name of the selected preset. Tap this button to show preset browser.

### 3. Parameter

Indicates name and value of the selected parameter. Use plus button, minus button and slider to adjust the value. Double tap to enable menu and tap on the name to show parameter list.

### 4. Synth

Tap this button to show synth menu.

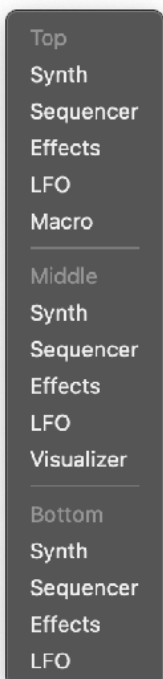

### 5. Keyboard

Tap this button to show keyboard. Hold this button (right click on macOS) to show keyboard menu.

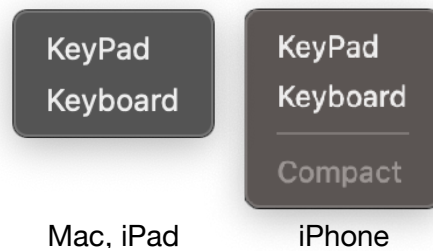

### 6. Visualizer

Tap this button to show audio visualization tool. Hold this button (right click on macOS) to show visualizer menu.

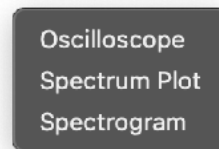

### 7. Sequencer

Tap this button to show sequencer. Hold this button (right click on macOS) to show sequencer menu.

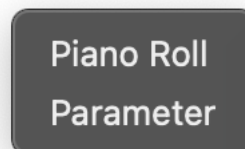

\* Content of the menu is dependent on the platform.

# Controller



---

## OSC1

1. Tune  
Adjust tuning in semi tones.
2. Fine  
Adjust fine tuning in cents.
3. PW  
Adjust pulse width for the pulse wave.
4. Shape  
Adjust shape of the waveform.
5. Level  
Adjust level of the oscillator output.

---

## OSC2

7. Tune  
Adjust tuning in semi tones.
8. Fine  
Adjust fine tuning in cents.
9. PW  
Adjust pulse width for the pulse wave.
10. Shape  
Adjust shape of the waveform.
11. Level  
Adjust level of the oscillator output.

---

## OSC3

13. Tune  
Adjust tuning in semi tones.
14. Fine  
Adjust fine tuning in cents.

15. PW  
Adjust pulse width for the pulse wave.
16. Shape  
Adjust shape of the waveform.
17. Level  
Adjust level of the oscillator output.

---

## VCF

19. Cutoff  
Adjust cutoff frequency of the filter.
20. Env Mod  
Adjust amount of envelope to modulate cutoff frequency.
21. Key Follow  
Adjust amount of key follow. When it is 100%, cutoff frequency is equals to note frequency.
22. Resonance  
Adjust amount of resonance.
23. LFO Mod  
Adjust amount of LFO to modulate cutoff frequency.
24. Key Track Gain  
Adjust amount of key track gain. Turn it clockwise to reduce gain of higher notes.

---

## VCA

25. Volume  
Adjust volume of VCA output.
26. AM  
Adjust amount of amplitude modulation.

27. Pan Mod  
Adjust amount of pan modulation.

28. Pan  
Adjust position of pan.

29. AM LFO  
Adjust amount of LFO1/LFO2 for Amplitude Modulation. Turn the dial counter clockwise to increase amount of LFO1. Turn the dial clockwise to increase amount of LFO2.

30. Pan LFO  
Adjust amount of LFO 1/LFO2 for Pan Modulation. Turn the dial counter clockwise to increase amount of LFO1. Turn the dial

clockwise to increase amount of LFO2. When dial is in center position, pan can be adjusted manually.

---

## Effect

31. Delay  
Adjust level of delay send.

32. C/F  
Adjust level of Chorus/Flanger send.

33. Reverb  
Adjust level of Reverb send.



---

## OSC1+

### 1. FM Amount

Adjust amount of frequency (pitch) modulation.

### 2. PWM Amount

Adjust amount of pulse width modulation.

### 4. FM LFO

Adjust amount of LFO1/LFO2 for frequency modulation. Turn the dial counter clockwise to increase amount of LFO1. Turn the dial clockwise to increase amount of LFO2.

### 5. PWM LFO

Adjust amount of LFO1/LFO2 for pulse width modulation. Turn the dial counter clockwise to increase amount of LFO1. Turn the dial clockwise to increase amount of LFO2.

---

## OSC2+

### 7. FM Amount

Adjust amount of frequency (pitch) modulation.

### 8. PWM Amount

Adjust amount of pulse width modulation.

### 10. FM LFO

Adjust amount of LFO1/LFO2 for frequency modulation. Turn the dial counter clockwise to increase amount of LFO1. Turn the dial clockwise to increase amount of LFO2.

### 11. PWM LFO

Adjust amount of LFO1/LFO2 for pulse width modulation. Turn the dial counter clockwise to increase amount of LFO1. Turn the dial clockwise to increase amount of LFO2.

---

## OSC3+

### 13. FM Amount

Adjust amount of frequency (pitch) modulation.

### 14. PWM Amount

Adjust amount of pulse width modulation.

### 16. FM LFO

Adjust amount of LFO1/LFO2 for frequency modulation. Turn the dial counter clockwise to increase amount of LFO1. Turn the dial clockwise to increase amount of LFO2.

### 17. PWM LFO

Adjust amount of LFO1/LFO2 for pulse width modulation. Turn the dial counter clockwise to increase amount of LFO1. Turn the dial clockwise to increase amount of LFO2.

---

## HPF

### 19. Cutoff

Adjust cutoff frequency of the filter.

### 20. Env Mod

Adjust amount of envelope to modulate cutoff frequency.

### 21. Key Follow

Adjust amount of key follow. When it is 100%, cutoff frequency is equals to note frequency.

### 22. Resonance

Adjust amount of resonance.

### 23. LFO Mod

Adjust amount of LFO to modulate cutoff frequency.

### 24. Noise

Adjust level of white noise.

---

## EG

### 25. Attack

Adjust attack time of the envelope.

26. Decay

Adjust decay time of the envelope.

27. Key Follow

Adjust amount of key follow. Duration of each stages is decreased when higher note is played.

28. Sustain

Adjust sustain level of the envelope.

29. Release

Adjust release time of the envelope.

30. Velocity

Adjust amount of velocity to modulate the level of envelope.



## LFO1

1. Tune  
Adjust pitch of the low frequency oscillator.
2. Shape  
Select shape of the low frequency oscillator waveform.
3. Delay  
Adjust delay time to start the low frequency oscillator.
4. Tempo Sync  
Turn it on to enable Tempo Sync.
5. Key Sync  
Turn it on to enable Key Sync.
6. Level  
Adjust level of LFO signal.

## LFO2

7. Tune  
Adjust pitch of the low frequency oscillator.
8. Shape  
Select shape of the low frequency oscillator waveform.
9. Delay  
Adjust delay time to start the low frequency oscillator.
10. Tempo Sync  
Turn it on to enable Tempo Sync.
11. Key Sync  
Turn it on to enable Key Sync.
12. Level  
Adjust level of LFO signal.

## LFO3

13. Tune  
Adjust pitch of the low frequency oscillator.
14. Shape  
Select shape of the low frequency oscillator waveform.
15. Delay  
Adjust delay time to start the low frequency oscillator.
16. Tempo Sync  
Turn it on to enable Tempo Sync.
17. Key Sync  
Turn it on to enable Key Sync.
18. Level  
Adjust level of LFO signal.

## LFO4

19. Tune  
Adjust pitch of the low frequency oscillator.
20. Shape  
Select shape of the low frequency oscillator waveform.
21. Delay  
Adjust delay time to start the low frequency oscillator.
22. Tempo Sync  
Turn it on to enable Tempo Sync.
23. Key Sync  
Turn it on to enable Key Sync.
24. Level  
Adjust level of LFO signal.

---

## LFO5 (Mod Wheel)

### 25. Tune

Adjust pitch of the low frequency oscillator.

### 26. Shape

Select shape of the low frequency oscillator waveform.

### 27. Delay

Adjust delay time to start the low frequency oscillator.

### 28. Tempo Sync

Turn it on to enable Tempo Sync.

### 29. Key Sync

Turn it on to enable Key Sync.

### 30. Level

Adjust level of LFO signal.

---

## Mod Wheel

### 31. Vibrato

Adjust amount of mod wheel for vibrato.

### 32. Tremolo

Adjust amount of mod wheel for tremolo.

### 33. LFO5

Select a target of LFO5 modulation. Options are LPF, HPF, VCA and Pan.



## Step Sequencer

1. Step1 Switch  
Enable / Disable trigger to the step.
2. Slide Switch  
Enable / Disable accent (trigger on) or slide (trigger off).
3. Gate1  
Adjust amount of Gate signal (Velocity) for the step.
4. CV1  
Adjust Amount of CV signal (Pitch) for the step.
5. Step2 Switch  
Enable / Disable trigger to the step.
6. Slide Switch  
Enable / Disable accent (trigger on) or slide (trigger off).
7. Gate2  
Adjust amount of Gate signal (Velocity) for the step.
8. CV2  
Adjust Amount of CV signal (Pitch) for the step.
9. Step3 Switch  
Enable / Disable trigger to the step.
10. Slide Switch  
Enable / Disable accent (trigger on) or slide (trigger off).
11. Gate3  
Adjust amount of Gate signal (Velocity) for the step.
12. CV3  
Adjust Amount of CV signal (Pitch) for the step.
13. Step4 Switch  
Enable / Disable trigger to the step.
14. Slide Switch  
Enable / Disable accent (trigger on) or slide (trigger off).
15. Gate4  
Adjust amount of Gate signal (Velocity) for the step.
16. CV4  
Adjust Amount of CV signal (Pitch) for the step.
17. Step5 Switch  
Turn it on to enable the step
18. Slide Switch  
Enable / Disable accent (trigger on) or slide (trigger off).
19. Gate5  
Enable / Disable trigger to the step.
20. CV5  
Adjust Amount of CV signal (Pitch) for the step.
21. Step6 Switch  
Enable / Disable trigger to the step.
22. Slide Switch  
Enable / Disable accent (trigger on) or slide (trigger off).
23. Gate6  
Adjust amount of Gate signal (Velocity) for the step.
24. CV6  
Adjust Amount of CV signal (Pitch) for the step.
25. Step7 Switch  
Enable / Disable trigger to the step.

26. Slide Switch  
Enable / Disable accent (trigger on) or slide (trigger off).

27. Gate7  
Adjust amount of Gate signal (Velocity) for the step.

28. CV7  
Adjust Amount of CV signal (Pitch) for the step.

29. Step8 Switch  
Enable / Disable trigger to the step.

30. Slide Switch  
Enable / Disable accent (trigger on) or slide (trigger off).

31. Gate8  
Adjust amount of Gate signal (Velocity) for the step.

32. CV8  
Adjust Amount of CV signal (Pitch) for the step.

33. Mode  
Select operation mode, mono, chord or Unison.

34. Rate  
Adjust frequency of clock to drive the sequencer.

35. Tempo Sync  
Turn it on to enable Tempo Sync.

36. Quantize  
Select a quantize option, Off, Minor or Major.

37. Steps  
Select number of steps

38. Gate  
Adjust pulse width of gate signal.

39. KBD Root Key Switch  
Enable / Disable pressed key on keyboard to set root key.

40. Root Key  
Select a Root Key when KBD Root switch is turned off.

41. Octave Range  
Select an Octave Range

42. Stop/Play  
Turn it on to enable sequencer for playing.  
Tap any key on keyboard to start the sequencer.



## Modulation

1. CV1\_1 ... CV1\_8  
Adjust amount of CV signal for the step.

2. CV2\_1 ... CV2\_8  
Adjust amount of CV signal for the step.

33. Clock Div 1  
Adjust speed of clock. Options are 1, 1/2, 1/4 and 1/8.

34. Clock Div 2

Adjust speed of clock. Options are 1, 1/2, 1/4 and 1/8.

35. Mod Attack  
Adjust attack time of envelope for modulation signal.

36. Mod Amount 1  
Adjust amount of modulation.

37. Mod Amount 2

Adjust amount of modulation.

### 38. Mod Release

Adjust release time of envelope for modulation signal.

### 39. Target 1

Select a target of the modulation. Options are LPF, HPF, VCA and EFX (Delay).

### 40. Target 2

Select a target of the modulation. Options are LPF, HPF, VCA and EFX (Delay).

### 41. Sync

Turn is on to sync phase of note sequencer and modulation sequencers.



## Sample & Hold

### 33. Hold

Select number of steps to hold the sampled CV.

Adjust balance of LFO1/LFO2 signal to be sampled for mod 1.

### 34. Hold 2

Select number of steps to hold the sampled CV for mod 1.

### 38. LFO Amount

Adjust balance of LFO1/LFO2 signal to be sampled for mod 2.

### 35. Hold 3

Select number of steps to hold the sampled CV for mod 2.

### 39. Noise Amount

Adjust amount of pink noise/white noise signal to be sampled.

### 36. LFO Amount

Adjust balance of LFO1/LFO2 signal to be sampled.

### 40. Noise Amount

Adjust amount of pink noise/white noise signal to be sampled for mod 1.

### 37. LFO Amount

### 41. Noise Amount

Adjust amount of pink noise/white noise signal to be sampled for mod 2.



## Delay

1. Delay Time  
Adjust delay time.
2. LFO Frequency  
Adjust frequency of LFO (low frequency oscillator).
3. HP Frequency  
Adjust frequency of high pass filter for the delayed sound.
4. Feedback  
Adjust amount of the feedback.
5. LFO intensity  
Adjust amount of LFO delay time modulation.
6. LP Frequency  
Adjust frequency of low pass filter for the delayed sound.

Sync Switch Tab  
Turn it on to enable tempo sync.

## Chorus / Flanger

7. LFO Frequency  
Adjust frequency of the LFO.
8. LFO intensity  
Adjust amount of LFO for delay time modulation.
9. Delay Time  
Adjust delay time.
10. Chorus/Flanger  
Select Chorus or Flanger.
11. Feedback  
Adjust amount of the feedback.
12. Stereo Width  
Adjust stereo width.

Sync Switch Tab  
Turn it on to enable tempo sync.

## Reverb

13. Room Size  
Adjust room size of the late reflection.
14. Decay  
Adjust decay of the late reflection.
15. Damping  
Adjust absorption of high frequency in the late reflection.
16. Auto Size  
Turn it on to enable auto size mode.
17. Pre Delay  
Adjust pre delay time of the early reflection.
18. Output LP Frequency  
Adjust frequency of output low pass filter.

Sync Switch Tab  
Turn it on to enable tempo sync.

## EQ and Mixer

19. High Frequency  
Adjust frequency of high shelving filter.
20. Mid Frequency  
Adjust frequency of mid peak / notch filter.
21. Low Frequency  
Adjust frequency of low shelving filter.
22. High Gain  
Adjust gain of the high shelving filter.
23. Mid Gain  
Adjust gain of the mid peak / notch filter.
24. Low Gain  
Adjust gain of the low shelving filter.

---

## Compressor

### 25. Reduction Gain Meter

Indicate amount of gain reduction.

### 26. Attack

Adjust time to start compression.

### 27. Threshold

Adjust level of threshold to begin compression.

### 29. Release

Adjust time to end compression.

### 30. Makeup

Adjust amount of makeup gain.

---

## Master Output

### 31. Volume

Adjust amount of master volume.

### 32. Pan

Adjust amount of master pan.

### 33. Mute

Turn it on to mute output signal.



## Chorus / Flanger

### 7. Sine/Triangle

Adjust shape of the LFO waveform, Sine or Triangle.

### 8. HP Frequency

Adjust frequency of high pass filter for the effected sound.

### 9. LP Frequency

Adjust frequency of high pass filter for the effected sound.

Adjust amount of LFO for delay time modulation.

### 18. EFX Input

Adjust amount of input signal from Delay and Chorus/Flanger.

## Mixer

### 19. Delay Level

Adjust level of Delay.

### 20. C/F Level

Adjust level of Chorus / Flanger.

### 21. Reverb Level

Adjust level of Reverb.

## Reverb

### 13. HP Frequency

Adjust frequency of input high pass filter.

### 14. LFO Frequency

Adjust frequency of LFO (Low Frequency Oscillator).

### 15. Early/Late

Adjust amount of the early reflection and amount of the late reflection.

### 16. LP Frequency

Adjust frequency of input low pass filter.

### 17. LFO intensity

## Compressor

### 26. Input Gain

Adjust amount of input gain.

### 27. HP Frequency

Adjust frequency of high pass filter at the input of the compressor.

### 29. Ratio

Adjust compression ratio.

### 30. Dry/Wet

Adjust amount of the dry and wet signal.



### A. Delay Sync Switch Tab

Turn it on to enable tempo sync.

### B. C/F Sync Switch Tab

Turn it on to enable tempo sync.

### C. Reverb Sync Switch Tab

Turn it on to enable tempo sync.

#### 1. Delay: Delay Time

Adjust delay time in note length.

#### 7. C/F: LFO Frequency

Adjust frequency in note length.

#### 13. Reverb: Room Size

Adjust room size in note length.

#### 14. Reverb: LFO Frequency

Adjust frequency in note length.

# Key Pad

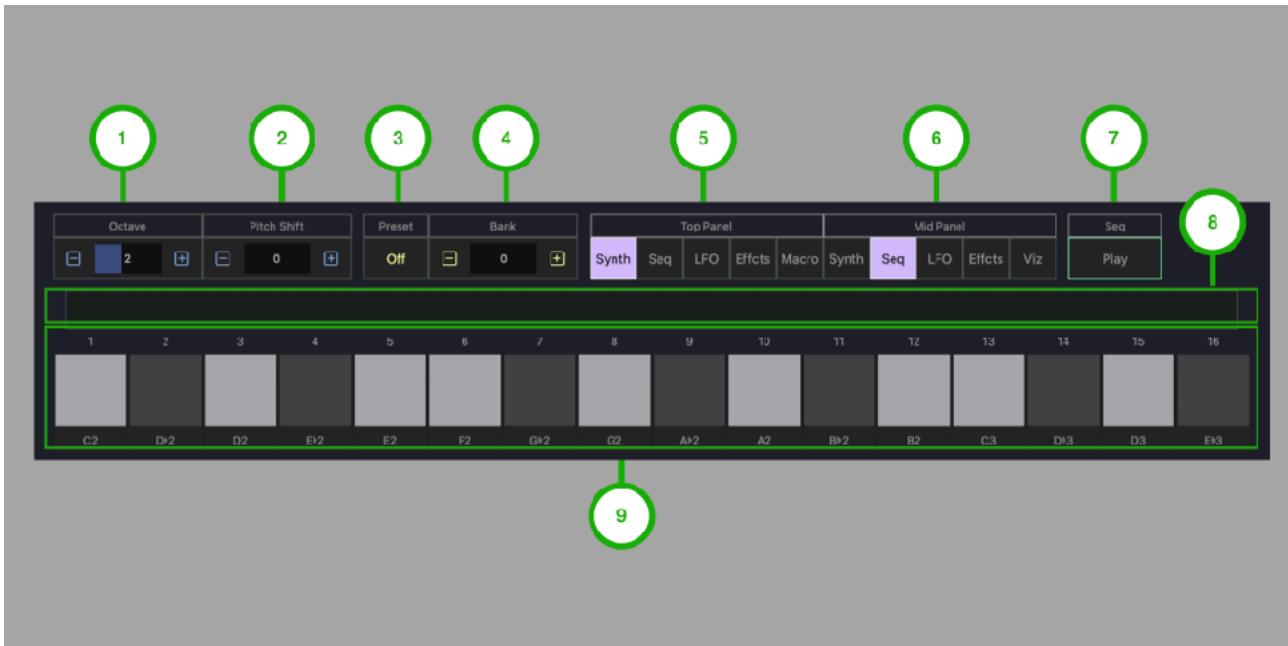

## 1. Octave Range

Use plus / minus buttons to adjust octave range of the key pad. Indicator shows octave of the lowest note of the key pad<sup>1</sup>. When “Midi Monitor” is enabled in Setting Panel, the range is automatically set based on the incoming midi note.

## 2. Pitch Shift

Use plus / minus buttons to adjust note range of the key pad.

## 3. Preset

Select preset type from the menu. Options are Off, Factory and User. Tap on a key pad to select a preset when factory or user is selected.

## 4. Bank

Select a preset bank. Preset number is pad number + bank \* 16.

## 5. Top Panel

Select a module for the top panel.

## 6. Mid Panel

Select a module for the mid panel.

## 7. Sequencer Play

Turn it on to enable sequencer for playing. Tap any key on key pad to start the sequencer.

## 8. Ribbon Controller

Drag on the Ribbon to adjust Pitch in linear scale.

## 9. Key Pad

Tap on the pad to play note or select preset when preset type is factory or user.

<sup>1</sup> Middle C (midi note 60) is C3.

# Keyboard

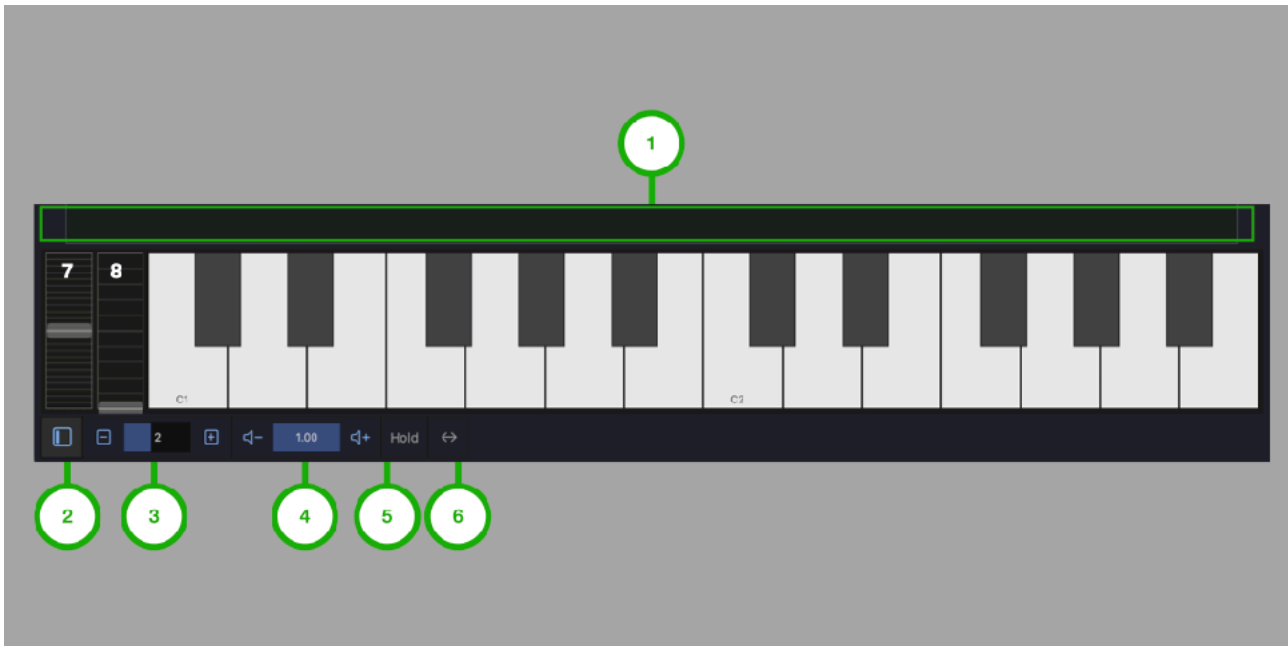

## 1. Ribbon Controller

Drag on the Ribbon to adjust Pitch in linear scale.

## 2. Wheel View Switch

Tap this button to show/hide pitch wheel and mod wheel.

## 3. Octave Range

Use plus / minus buttons to adjust octave range of the keyboard. Indicator shows lowest note of the keyboard<sup>2</sup>. When “Midi Monitor” is enabled in Setting Panel, the range is automatically set based on the incoming midi note.

## 4. Velocity

Use plus/minus button to adjust keyboard velocity.

## 5. Hold

Tap this button to enable /disable key holding.

## 6. Scroll

Tap this button to enable/disable keyboard scrolling.

## 7. Pitch Wheel

Adjust pitch of the oscillators in exponential scale. Range is plus / minus one octave.

## 8. Mod Wheel

Adjust amount of the modulation. Targets of the modulation can be adjusted in LFO Panel.

<sup>2</sup> Middle C (midi note 60) is C3.

# Visualizer

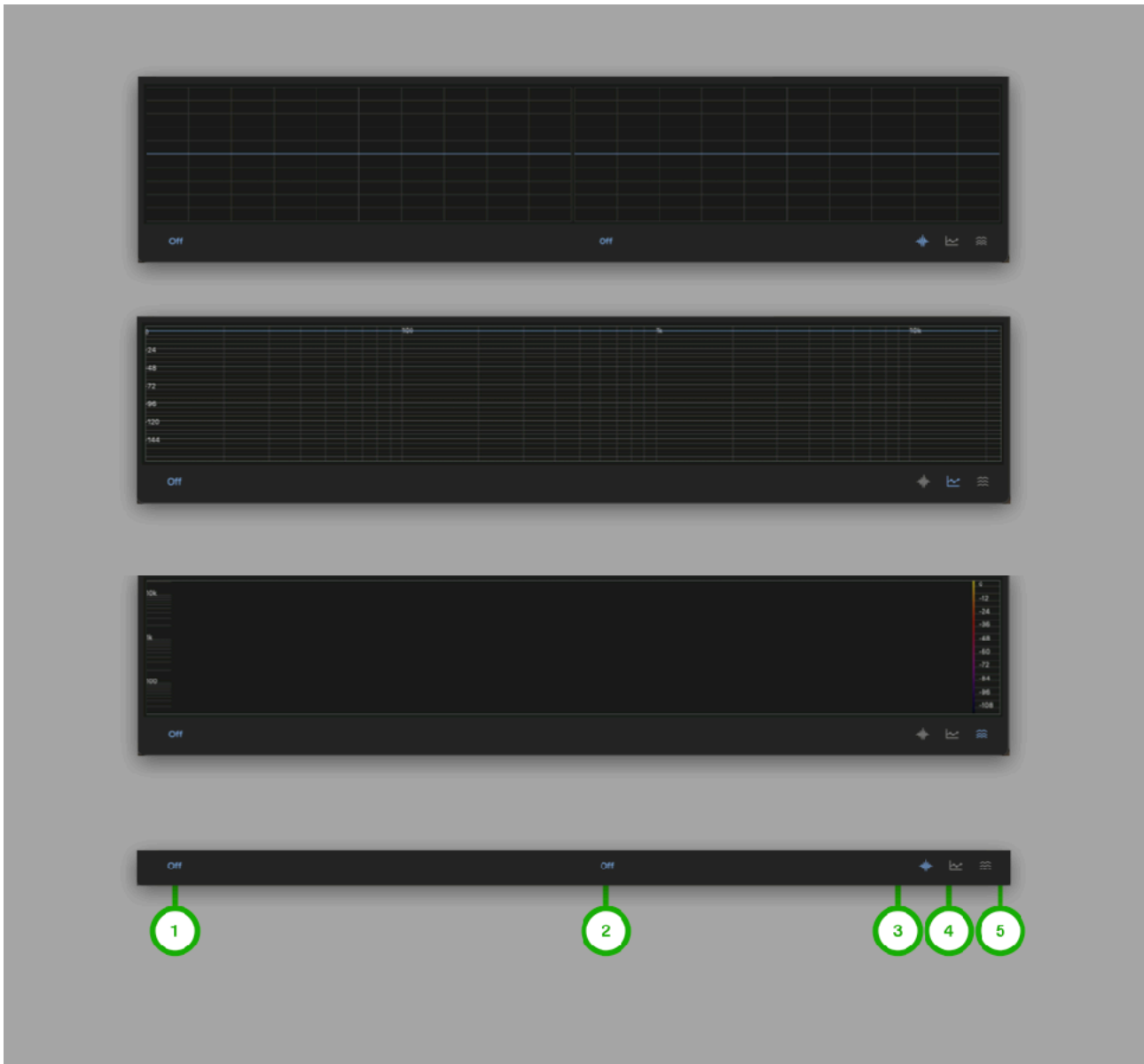

1. Audio Source Selector  
Tap this button to show a list. Select audio source for the visualization.

2. Audio Source Selector  
Tap this button to show a list. Select audio source for the visualization.

3. Oscilloscope Button  
Tap this button to select Oscilloscope.

4. Spectrum Plot Button  
Tap this button to select Spectrum Plot.

5. Spectrogram Button  
Tap this button to select Spectrogram.

Tap and hold (right click on macOS) to show context menu.

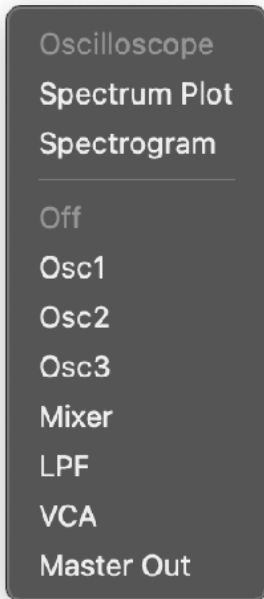

Select a tool for audio visualization. Options are Oscilloscope, Spectrum Plot and Spectrogram.



Select a source of audio for the visualization.

# Sequencer (Piano Roll)

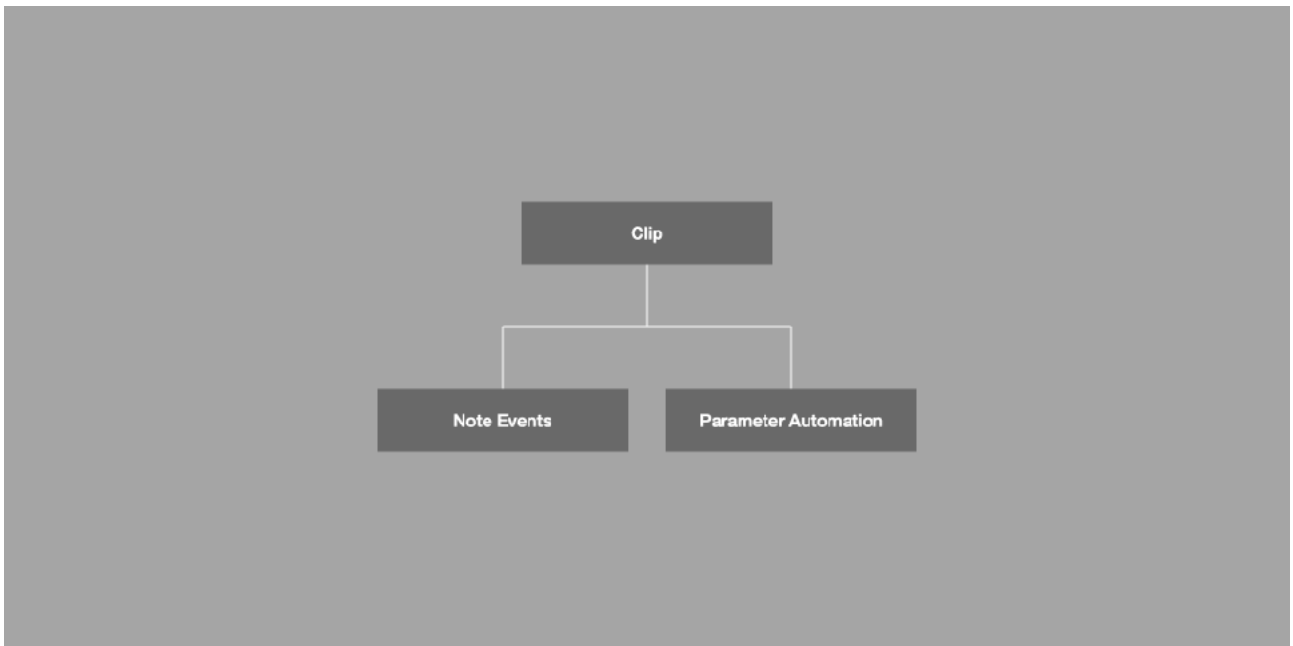
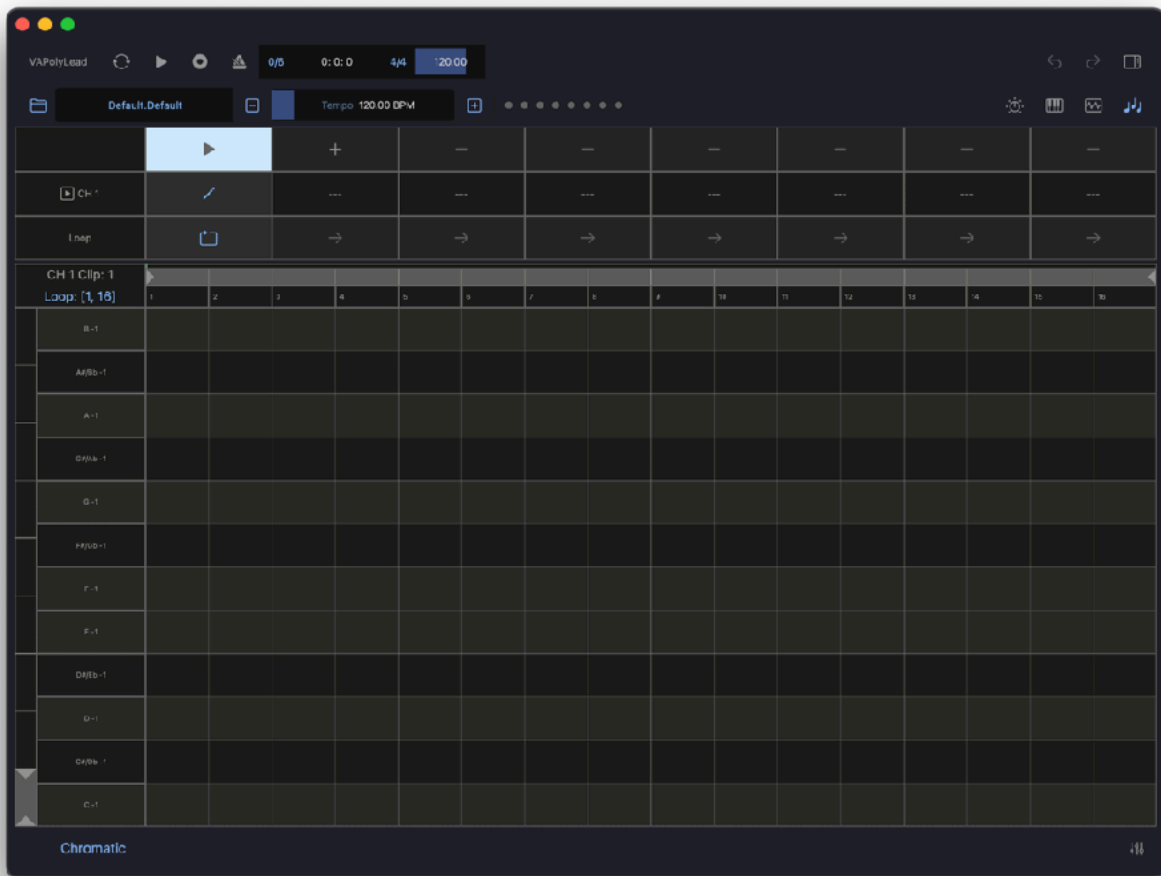

Clip contains note events and parameter automation events for each timbral. Maximum length of clip is 16 bars. Maximum number of clips are 8.

## Clip Editor

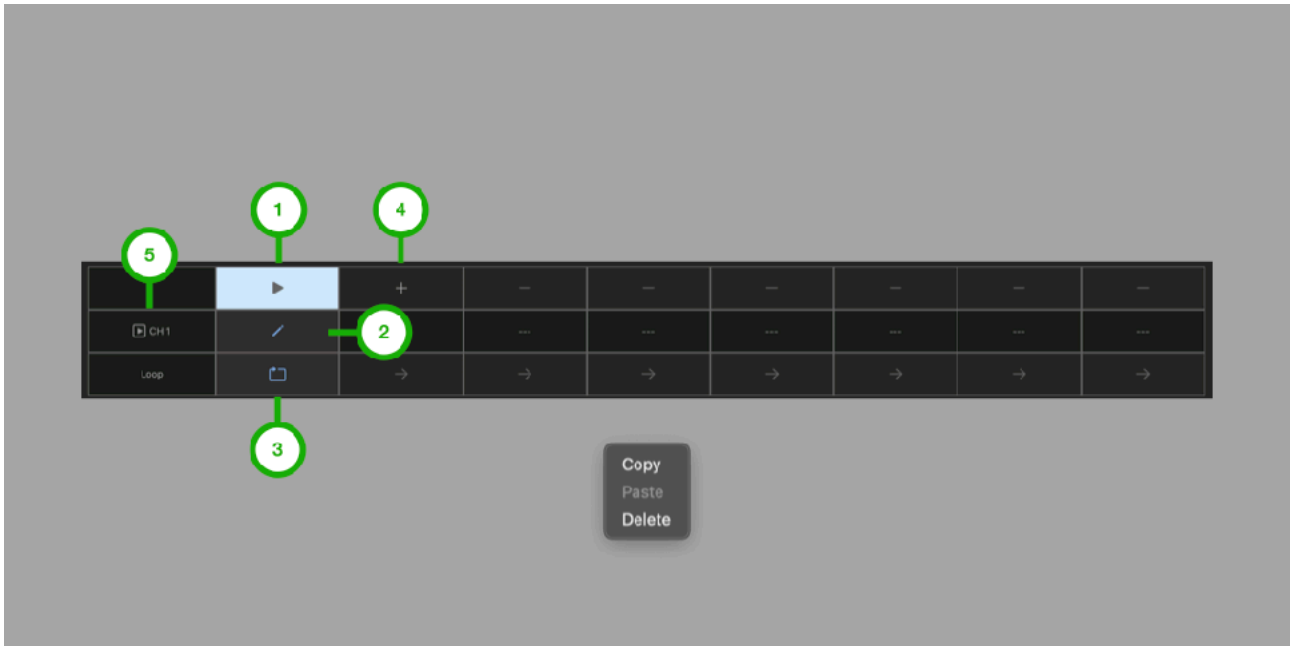

### 1. Launch Button

Tap this button to play/stop clip.

### 2. Edit Button

Tap this button to open piano roll editor.

### 3. Loop Selector

Select loop options.

### 4. Add Button

Tap this button to add edit button.

### 5. Auto Select Button

Enable/Disable Auto Select to select editor while sequencer is playing.

# Piano Roll Editor

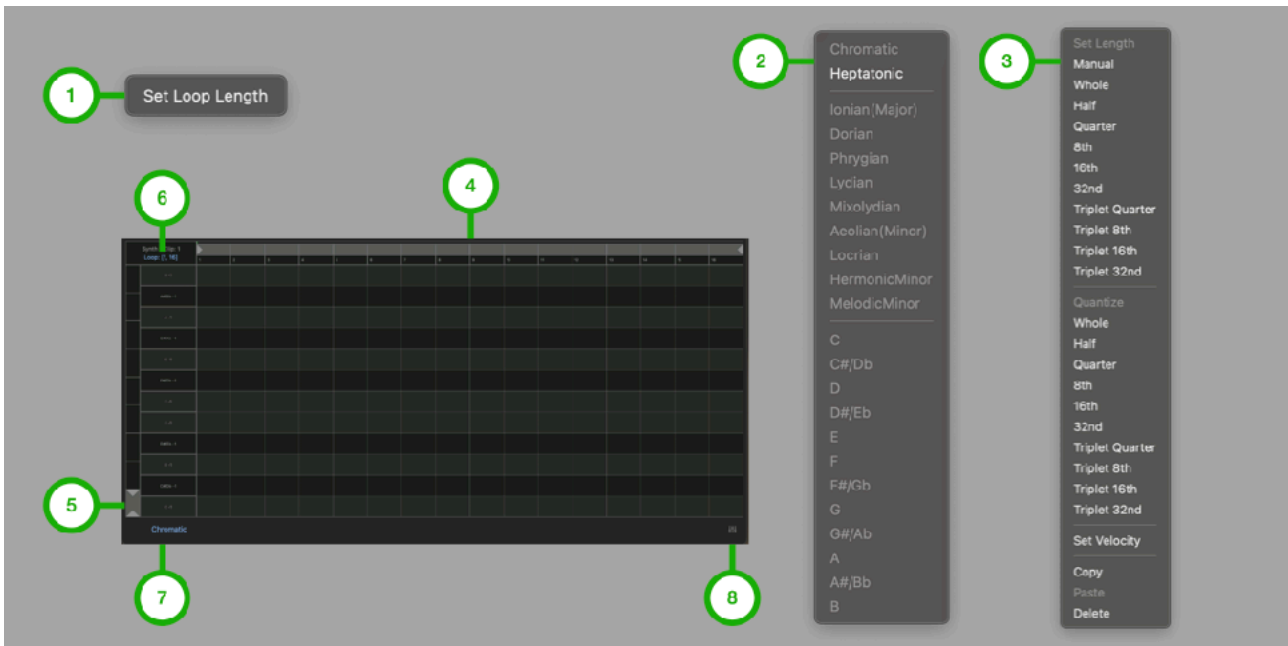

## 1. Loop Menu

Press and hold (right click on macOS) Time Range Selector to show this menu. Tap on “Set Loop Length” to set loop length to current length selected by the Time Range Selector.

## 2. Scale Menu

Press and hold (right click on macOS) editor to show this menu.

## 3. Editing Menu

Press and hold (right click on macOS) note to show this menu.

## 4. Time Range Selector

Select time range for editing and for loop length. On iOS, pinch gesture control zooming and drag gesture control scroll position.

## 5. Note Range Selector

Select note range for editing. On iOS, pinch gesture control zooming and drag gesture control scroll position.

## 6. Loop Range

Tap this button to show Loop Menu.

## 7. Scale

Tap this button to show Scale Menu

## 8. Parameter Automation Button

Tap this button to show Parameter Automation Editor

## Parameter Automation Editor

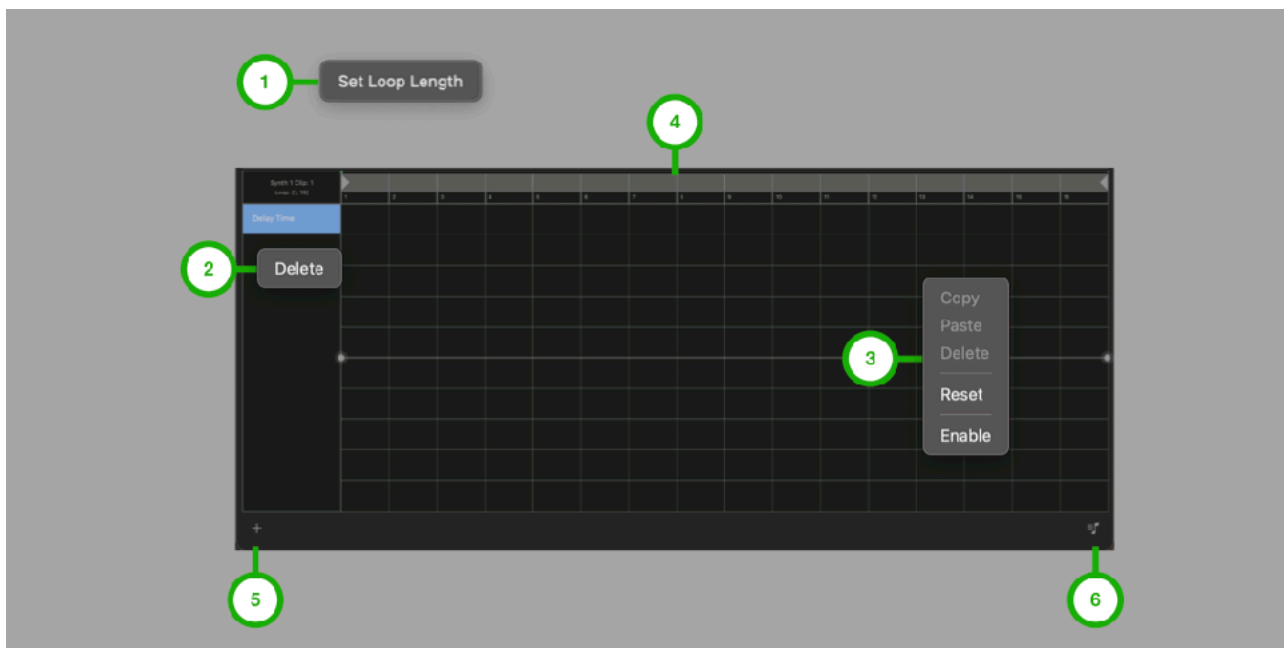
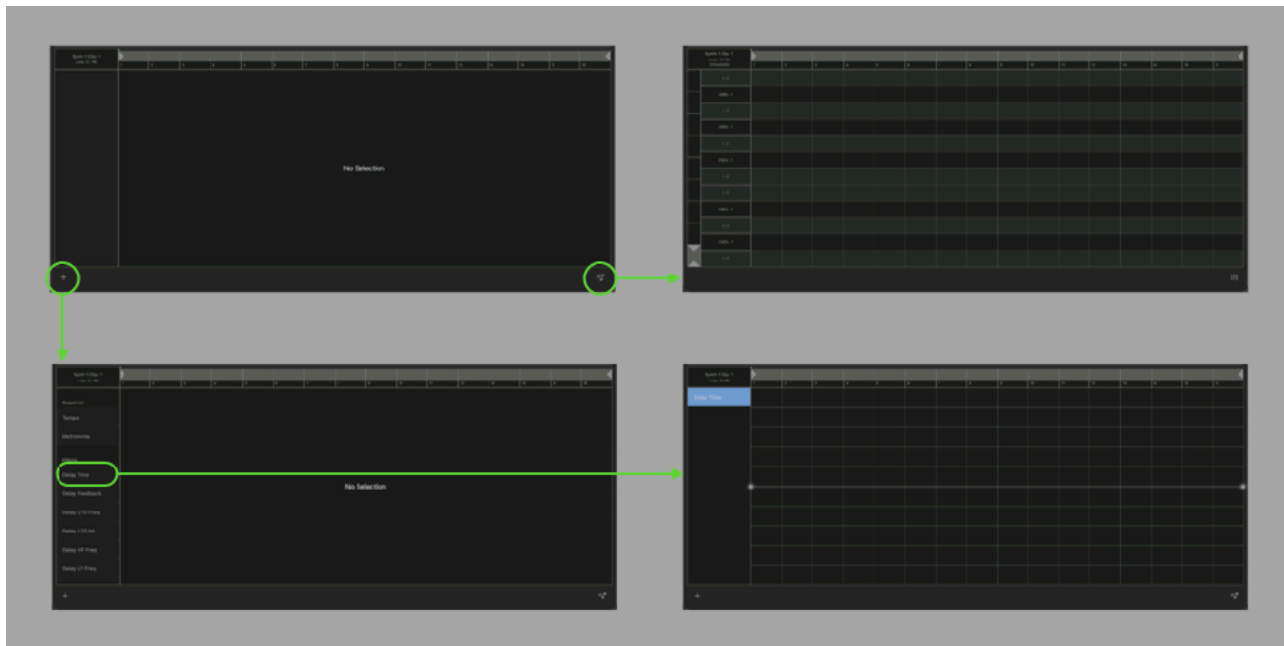

### 1. Loop Menu

Press and hold (right click on macOS) Time Range Selector to show this menu. Tap on “Set Loop Length” to set loop length to current length selected by the Time Range Selector.

### 2. List Menu

Press and hold (right click on macOS) item in parameter list to show this menu.

### 3. Editing Menu

Press and hold (right click on macOS) editor to show this menu.

### 4. Time Range Selector

Select time range for editing and for loop length.

### 5. Add Button

Tap this button to select parameter to edit.

### 6. Piano Roll Button

Tap this button to show piano roll editor.

# Synthesizer

VAPolyLead is polyphonic synthesizer consists of oscillator1, oscillator2, oscillator3, mixer, resonant low pass filter, resonant high pass filter, amplifier, ADSR envelope and five LFOs. Output of the synthesizer is routed to effects, mixer, EQ, compressor and main output amplifier.

## Block diagram

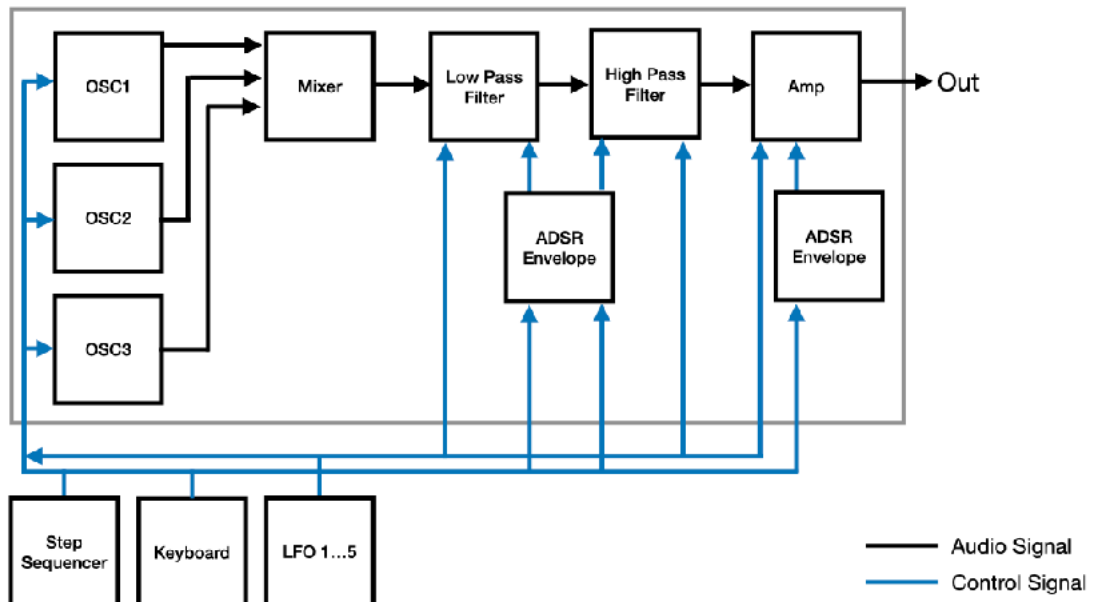
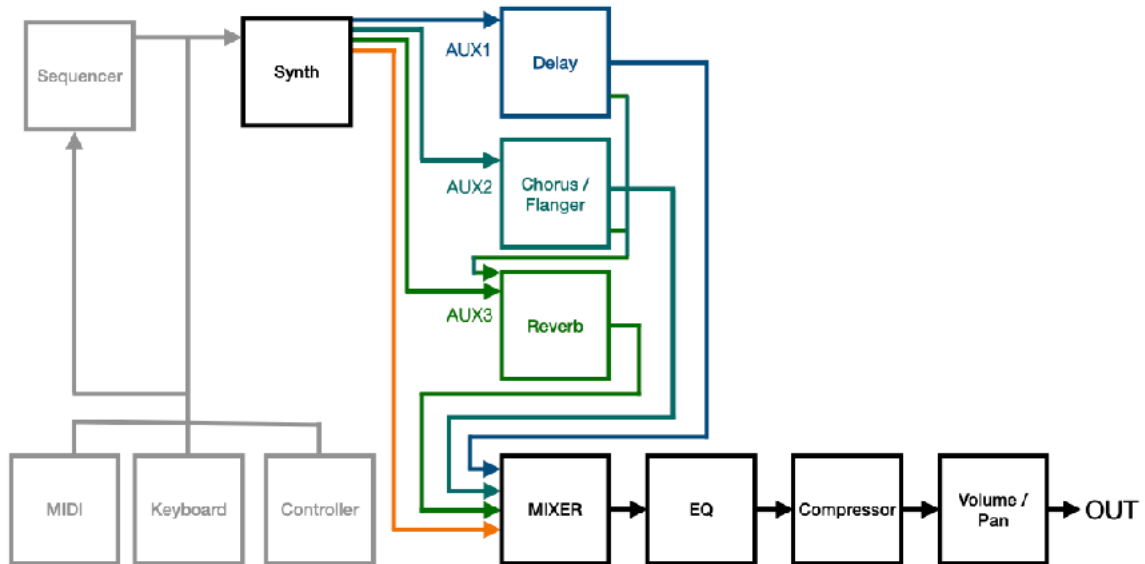

## Control Signal & MIDI Flow

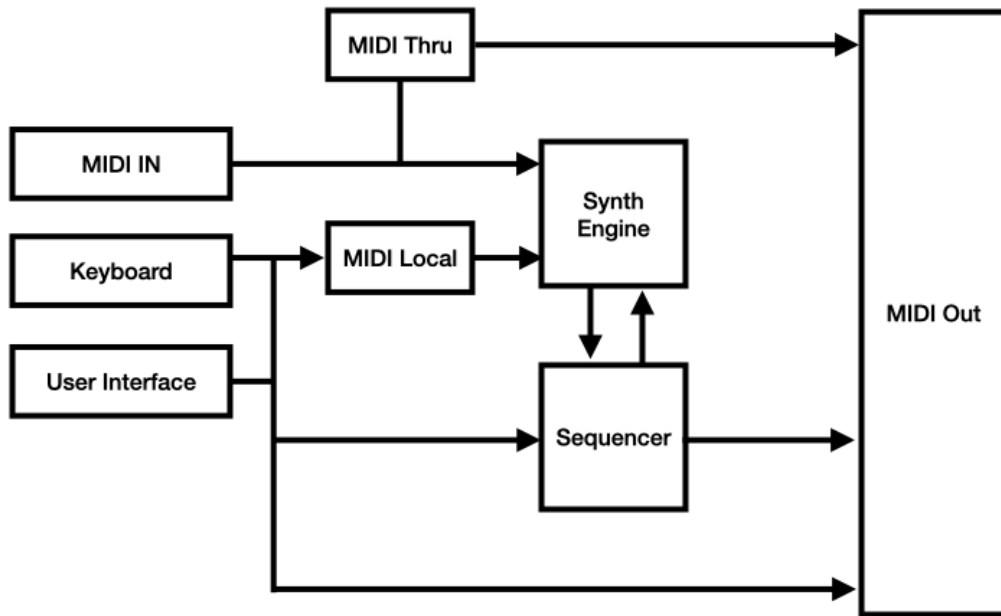

# Oscillators

Oscillator 1, 2 & 3 features continuously variable waveform oscillator.



## Tune

Adjust pitch of the oscillator. (maximum +/- 24 semitones)

When Square wave is selected, pulse width of 0% and 100% produce DC signal<sup>3</sup> resulting no audible output.

## Fine

Adjust pitch of the oscillator. (+/- 50 cents)  
Use Fine Tune to detuning the oscillator relative to the other oscillators.

## Shape

Adjust shape of the waveform. Fully counter clockwise position is Sine, center is Saw, and fully clockwise position is Square.

## PW (Pulse Width)

Adjust pulse width of the square (pulse) wave.

## Level

Adjust output level of oscillator in dB scale from -60 dB to 0 dB.



## FM Amount

Adjust amount of exponential frequency modulation.

octaves. Set the value to 0.5 for +/- 2 octaves and 0.25 for +/- 1 octaves.

## FM LFO

Adjust amount of LFO1/LFO2 signal for frequency modulation. Turn the dial counter clockwise to increase amount of LFO1. Turn the dial clockwise to increase amount of LFO2. Range of the modulation is +/- 4

## FM Env

Adjust amount of envelope signal for frequency modulation.

<sup>3</sup> DC Signal is always positive or always negative and produce no sound.

---

## PWM Amount

Adjust amount of pulse width modulation.

---

## PWM LFO

Adjust amount of LFO1/LFO2 signal for pulse width modulation. Turn the dial counter clockwise to increase amount of LFO1. Turn the dial clockwise to increase amount of LFO2.

---

## PWM Env

Adjust amount of envelope signal for pulse width modulation.

## VCF (Low Pass Filter & High Pass Filter)

Low pass filter is modeled on -12 dB per octave Sallen-Key low pass filter circuit. High pass filter is modeled on -6dB per octave Sallen-Key high pass filter circuit. Cutoff frequency of the filter is modulated by filter envelope. Cutoff can be modulated by LFO3 or LFO4.



---

### Cutoff

Adjusts the cutoff frequency of the filter.

---

### Resonance

Adjusts amount of resonance.

---

### Env Mod

Adjust amount of envelope to modulate cutoff frequency.

---

### LFO Mod

Adjust amount of LFO1/LFO2 signal for cutoff modulation. Turn the dial counter clockwise to

increase amount of LFO1. Turn the dial clockwise to increase amount of LFO2.

---

### Key Follow

Adjust amount of key follow. When it is 100%, cutoff frequency is equals to keyboard note frequency.

---

### Key Track Gain

Adjust amount of key track gain. Turn it clockwise to reduce level of higher notes.

---

### Noise

Adjust level of white noise.

## VCA (Amplifier)

The output signal of the filter is routed to the amplifier. The amount of amplifier gain is controlled by envelope. Amplifier gain and amount of pan can be modulated by LFO3 or LFO4.



---

### Volume

Adjust volume of Output Signal.

---

### Pan

Adjust position of pan.

---

### AM

Adjust amount of LFO to modulate amplitude.

---

### Pan Mod

Adjust amount of LFO to modulate pan.

---

---

### AM LFO

Adjust amount of LFO3/LFO4 signal for amplifier modulation. Turn the dial counter clockwise to increase amount of LFO3. Turn the dial clockwise to increase amount of LFO4.

---

### Pan LFO

Adjust amount of LFO3/LFO4 signal for pan modulation. Turn the dial counter clockwise to increase amount of LFO3. Turn the dial clockwise to increase amount of LFO4.

---

## EFX Send



---

### Delay Send

Adjust level of the signal send to delay effect.

---

### C/F Send

Adjust level of the signal send to chorus / flanger effect.

---

### Reverb Send

Adjust level of the signal send to reverb effect.

# EG (ADSR Envelope Generator)

ADSR is an analog style non-linear envelope generator.



---

## Attack

Adjust the attack time of the ADSR envelope (from 1 ms to 6 sec)

---

## Decay

Adjust the decay time of the ADSR envelope (from 1 ms to 10 sec)

---

## Sustain

Adjust sustain amount of the ADSR envelope (from 0% to 100%)

---

## Release

Adjust release time of the ADSR envelope (from 1 ms to 10 sec)

---

## Velocity

Adjust amount that Keyboard velocity affect level of envelope.

---

## Key Follow

Adjust amount that CV affect length of envelope.

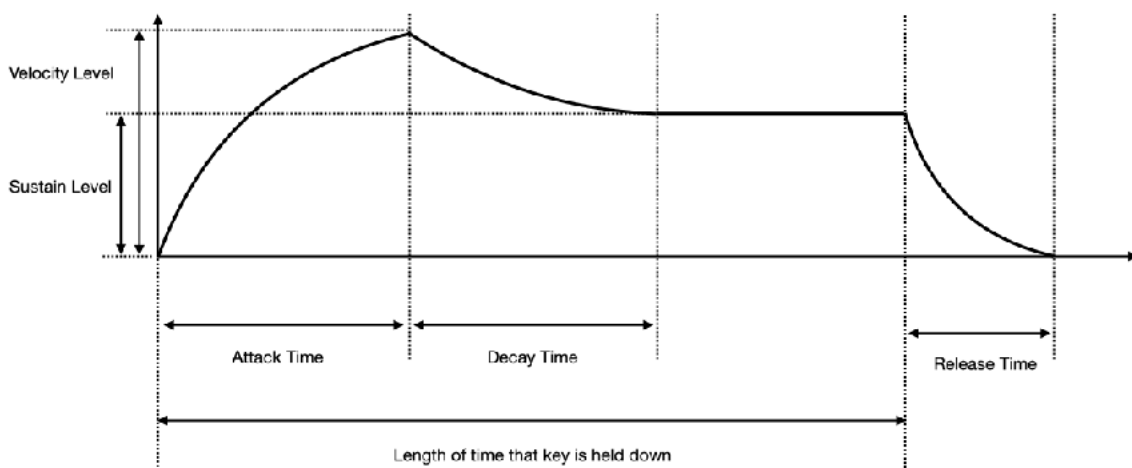

# LFO

LFO (Low Frequency Oscillator) can generate 6 wave shapes and the frequency of the LFO can be set by Hz or note value when LFO is synchronized to tempo.



## Tune

Adjust frequency of the LFO. When sync is off, range of the frequency is from 0.04Hz to 42.2Hz. When sync is on, range of the rate is from 1/64 to 8 bars.

## Shape

Select shape of the LFO waveform. Wave shapes are sine, saw, down saw, square, triangle and random.

## Delay

Adjust delay time to start the LFO signal.

## Tempo Sync

Turn this switch on to sync the rate of the LFO with tempo.

## Key Sync (Key Re-Trigger)

Turn this switch on to restart the LFO cycle every time a new note is played. When step sequencer is running, restart LFO cycle when step is returned to step 1.

## Level

Adjust level of LFO signal.

# Mod Wheel Target



## Vibrato

Adjust amount of mod wheel for vibrato.

## Tremolo

Adjust amount of mod wheel for tremolo.

## LFO5

Select a target of LFO5 modulation. Options are LPF, HPF, VCA and Pan.

## Output Mixer

Output Signals from the effects can be adjusted by output mixer.



---

### Delay Level

Adjust level of delay signal to EQ.

---

### C/F Level

Adjust level of Chorus / Flanger signal to EQ.

---

### Reverb Level

Adjust level of Reverb Signal to EQ.

## Master Output

Level and Pan of the master output can be adjusted in master section.



---

### Volume

Adjust level of the master output.

---

### Pan

Adjust pan of the master output.

---

### Mute

Turn on to mute master output.

# Step Sequencer

3 channel Analog Style 8 Step Sequencer to play notes and modulate parameters.



## Step



Slide is off

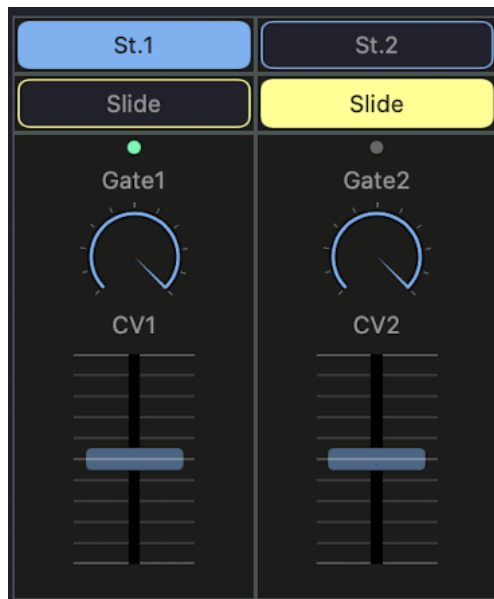

Slide is on

## Step Switch

Enable / Disable trigger to the step.

## Slide Switch

Enable / Disable slide (when trigger is off).

## Gate

Adjust amount of Gate signal (Velocity) for the step. Range is from 0% to 100%.

## CV

Adjust Amount of CV signal (Pitch) for the step. Range is one octave. Note value varies by setting of Root Key and Octave Range.

## Sequencer Options



---

### Play

Turn it on to enable sequencer for playing. Tap any key on keyboard to start the sequencer.

---

### Mode

Select an operation mode. Options are Mono, Chord, Unison and Off. When chord is selected, use Quantize option to select Minor or Major.

---

### Rate

Adjust frequency of clock to drive the sequencer.

---

### Tempo Sync

Turn it on to enable Tempo Sync.

---

### Quantize

Select a quantize option for CV signal. Options are Minor, Major and Off.

---

### Steps

Select number of steps for the loop.

---

### Gate

Adjust pulse width of gate signal.

---

### KBD Root

Enable / Disable pressed note on keyboard to set root key.

---

### Root Key

Select a Root Key of CV signal. Range is from C-2 to C8 (MIDI 0 ... 127).

---

### Octave Range

Select an Octave Range of CV slider. Range is from 1 octave to 10 octaves.

## Modulation

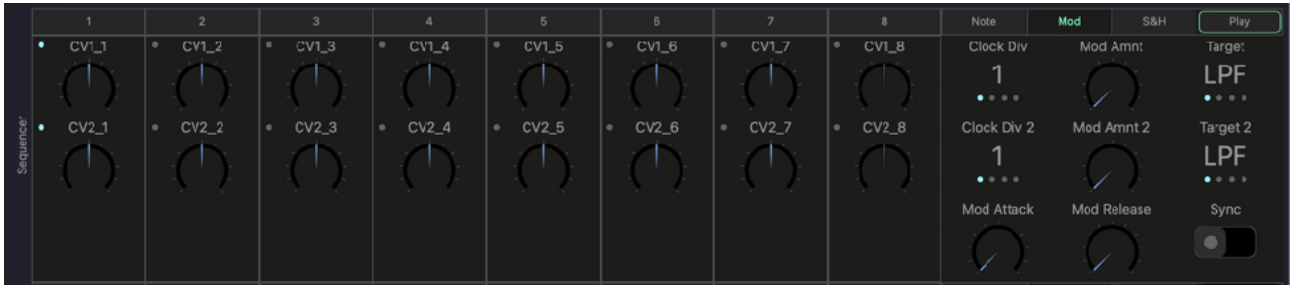

---

### Clock Division

Adjust speed of sequencer for modulation signal. Options are 1, 1/2, 1/4 and 1/8.

---

### Mod Amount

Adjust amount of modulation.

---

### Target

Select a target of modulation. Options are LPF, HPF, VCA and EFX (Delay).

---

### Mod Attack

Adjust attack time of envelope for modulation signal.

---

### Mod Release

Adjust release time of envelope for modulation signal.

---

### Sync

Enable this option to sync phase of note sequencer and modulation sequencers.

## S&H



### Hold

Select number of steps to hold the sampled CV sequences. Options are 8, 16, 32, 64, 128, 256 and off. When the value is 256, 8 steps are repeated 32 times. Length of the loop is depended on the Clock Rate.

### LFO1/LFO2

Adjust balance of LFO1/LFO2 signal to be sampled on active step.

### Pink/White

Adjust amount of pink noise / white noise signal to be mixed with LFO signal to be sampled on the active step.

---

## Sync with Transport Control

Play/Stop button of build-in piano roll sequencer or host application can start and stop step sequencer.

Enable CVSEQ PLAY OVERRIDE in setting panel.

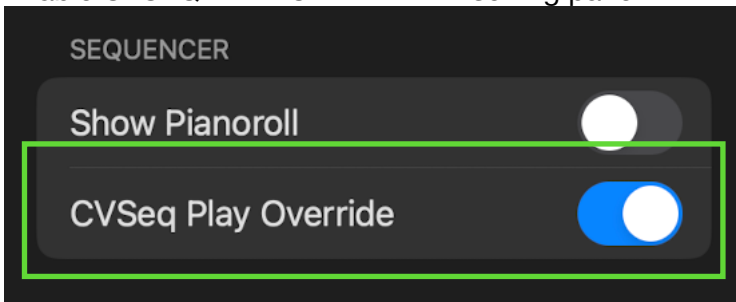

Enable Host Sync to be control by the host application.



Press Play Button of build-in piano roll sequencer or host application starts step sequencer and it is indicated by the play button of the step sequencer.

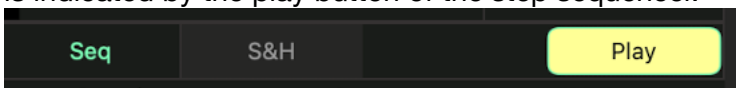

# Effects

## Delay

### Signal Flow

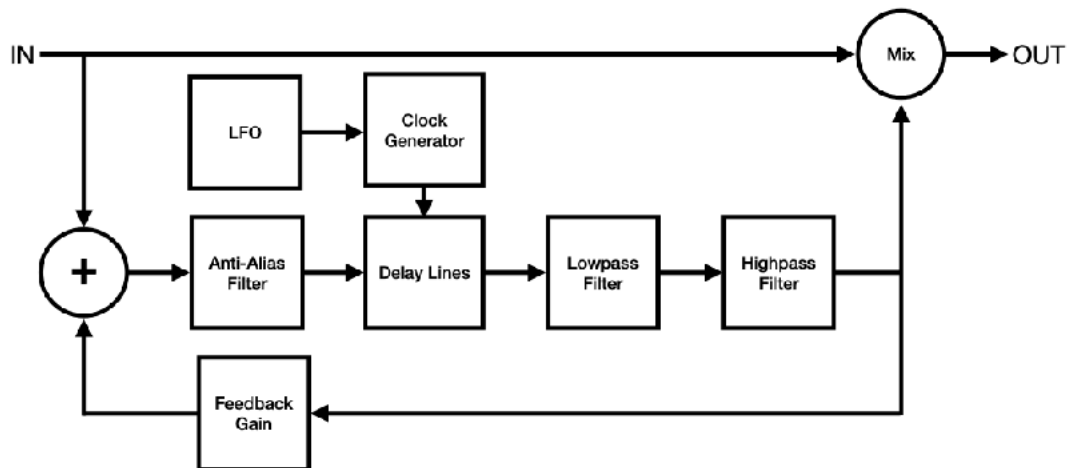

### Delay Time

Adjust delay time from 20 ms to 1200 ms. When sync switch is turned on, delay time can be set as note value which is synchronized to the tempo. Valid range of the note value is automatically adjusted base on the current tempo.

### Regeneration

Adjust feedback from 0 % to 100 %. You can change sound of the feedback by adjusting frequency of the high-pass filter and the low-pass filter.

### Modulation

Modulation can be applied to the delayed signal. LFO (Low Frequency Oscillator) generates sine wave for the modulation.

Adjust LFO frequency from 0.01 Hz to 10 Hz.

Adjust LFO Intensity from 0 to 1.0, which adjust modulation width from 0 ms to +/- 10 ms.

# Chorus / Flanger

## Signal Flow

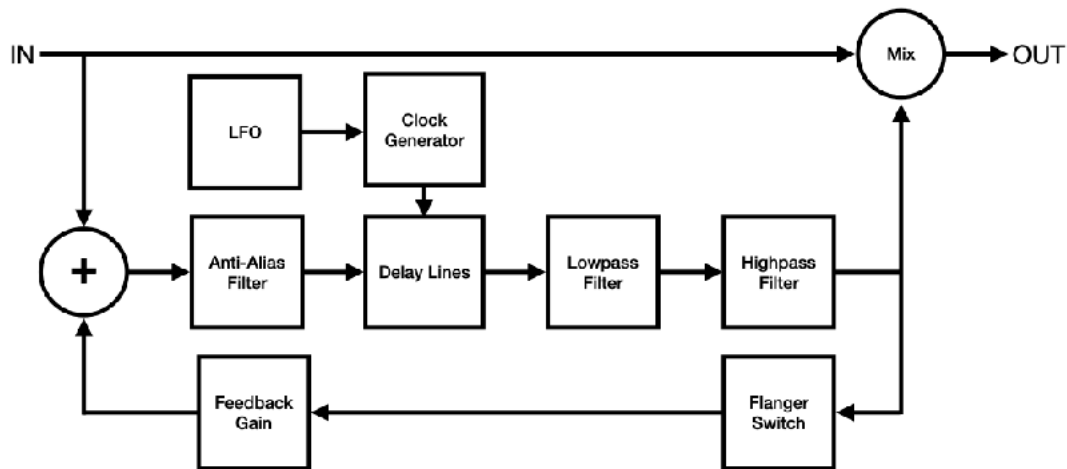

## Input Signal Level

Level of input signal should be about -6dB or less. If the input signal is too hot, it will cause distortion in output signal.

## Effect Type

Select effect type from chorus or flanger. Ranges of the delay time and the LFO Intensity change based on the selected effect type.

## Modulation Speed

LFO Frequency dial controls speed of the modulation. When sync switch is turned on, LFO Frequency can be set as note value which is synchronized to the tempo. Valid range of the note value is automatically adjusted base on the current tempo.

## Modulation Width

LFO Intensity dial controls width of the modulation and delay time dial controls center position of the modulation.

When chorus effect is selected, range of the LFO intensity is from 0 ms to 1 ms and range of the delay time is from 1 ms to 40 ms.

When flanger effect is selected, range of the LFO intensity is from 0 ms to 12 ms and range of the delay time is from 1 ms to 13 ms.

Rotate delay time dial counterclockwise to emphasize higher frequency or clockwise to emphasize lower frequency.<sup>4</sup>

## LFO Shape

LFO shape dial controls shape of the LFO waveform. When the dial is rotated fully counterclockwise, shape of the waveform is sine wave. When the dial is rotated fully clockwise, shape of the waveform is triangle wave.

## Stereo Width

Stereo Width dial controls phase offset of the LFO. When the dial is rotated fully counterclockwise, stereo width is 0%. (phase offset is 0 degree) When the dial is rotated fully clockwise, stereo width is 100%. (phase offset is 180 degree)

## Regeneration

Feedback dial controls amount of regeneration from 0 % to 100 %. Turning the feedback dial clockwise enhances amount of the feedback effect.

<sup>4</sup> If compared with manual knob of the analog flanger guitar pedal, emphasized frequency moves reverse direction.

---

## Filters

Delayed signal is routed to high-pass filter and low-pass filter before mixed with dry signal. HP frequency controls frequency of the high-pass filter. LP frequency controls frequency of the low-pass filter.

# Reverb

## Signal Flow

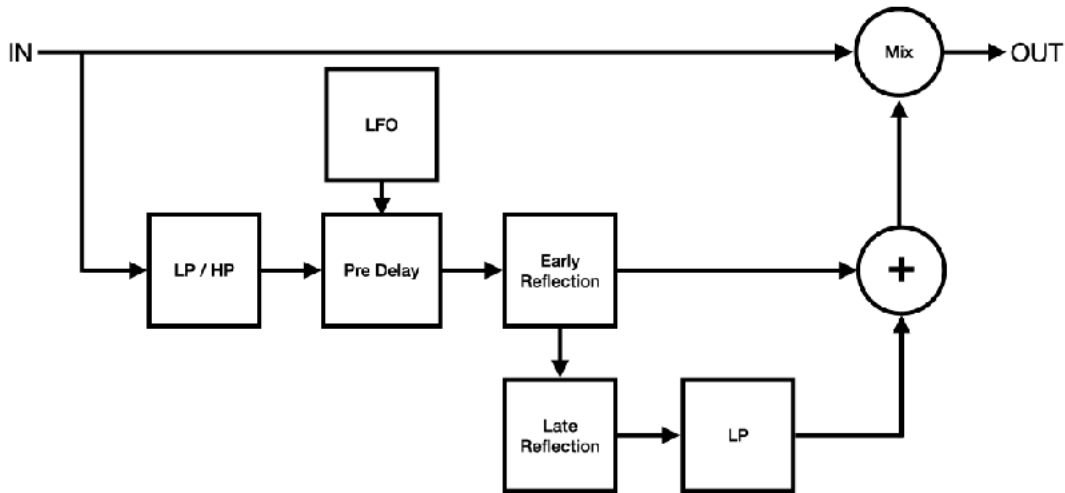

### Input Filter

Use Lowpass filter and high-pass filter to attenuate high frequency and low frequency of the input signal.

### Pre Delay

Use pre delay to adjust amount of the time between the direct signal and beginning of the early reflection signal. This parameter can be used to express size of the space. Reflection takes short time to bounce back in small room and it takes long time in large room. Also this parameter can be used to separate dry signal and reverb signal in the mix.

### Modulation Speed

LFO Frequency dial controls speed of the modulation. When sync switch is turned on, LFO Frequency can be set as note value which is synchronized to the tempo. Valid range of the note value is automatically adjusted base on the current tempo.

### Modulation Width

LFO Intensity dial controls width of the modulation and pre delay time dial controls center position of the modulation. Range of the LFO intensity is from 0 ms to +/- 10 ms.

### Size and Decay

Size dial controls reverb time of late reflection and decay dial controls length of the reverb tail. Decay time can be used to express size of the space and material of the surface. Reflective materials, such as concrete or hardwood, gives longer decay time.

When auto size switch is turned on, size dial controls value of the parameters including size, pre delay, decay, damp, output LP frequency and early/late mix.

When sync switch is turned on in auto size mode, total reverb length, which can be controlled by pre delay, size and decay, is adjusted by note value which is synchronized to the tempo.

### Damping

Damp dial controls amount of high frequency absorption for the late reflection signal. Low damping values produce brighter reverb sound and high damping values produces darker reverb sound.

### Output Filter

Use lowpass filter to cut high frequency of the reverb signal.

---

## Early / Late Mix

Adjust balance of the early reflection signal and late reflection signal from 0% (early reflection ) to 100% (late reflection).

# Equalizer

---

## Low Shelving

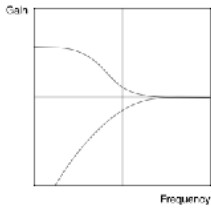

Adjust frequency of the filter from 21 Hz to 1092 Hz.  
Adjust gain from minus infinity to +12 dB  
When gain is turned fully anti clock wise, the filer becomes high pass filter.

---

## Mid Peak / Notch

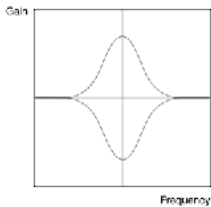

Adjust frequency of the filter from 151 Hz to 2389 Hz.  
Adjust gain from -14 dB to +14 dB  
Bandwidth is fixed to one octave.

---

## High Shelving

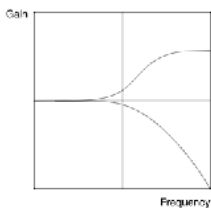

Adjust frequency of the filter from 296 Hz to 21096 Hz.  
Adjust gain from minus infinity to +12 dB  
When gain is turned fully anti clock wise, the filer becomes low pass filter.

# Compressor

## Overview

The compressor reduces dynamic range of audio signal. This is achieved by feedback topology as shown in the diagram below.

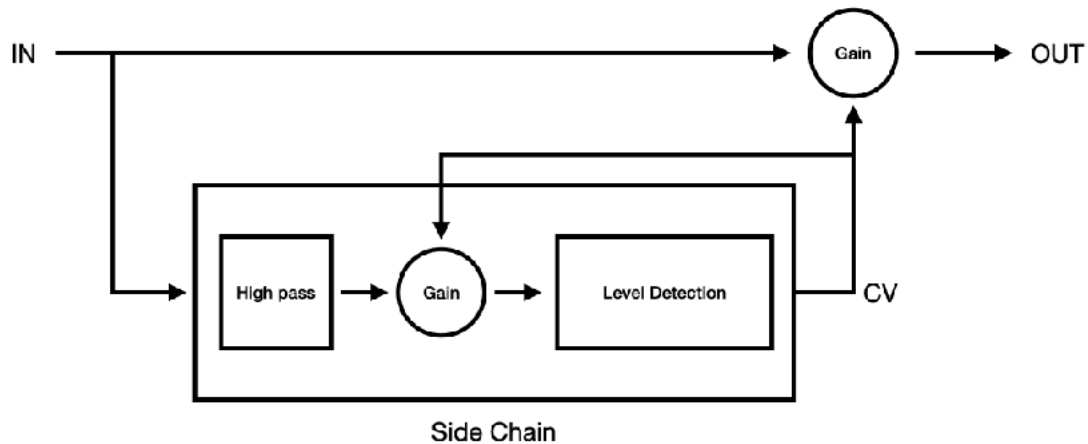

High pass filter is applied to the input of the side chain and the signal is routed to the gain stage in the side chain. The output of the gain stage is routed to the level detection. The level detector detects level of the input signal and generates control signal based on the level of the gain reduction required. The control signal is routed to the amplifier in the gain stage in the side chain to adjust level of the input signal from the high pass filter. The same control signal is also routed to the amplifier of the main gain stage to adjust level of the input signal.

The feedback topology is common in early analog compressors. Although there are several disadvantages to this topology, it is considered more musical than feed-forward design used in modern compressors. The feedback loop is implemented without unit delay to emulate behavior of the analog circuit.

## Threshold and Ratio

When level of the input signal passes above the threshold, the input signal is compressed by the ratio.

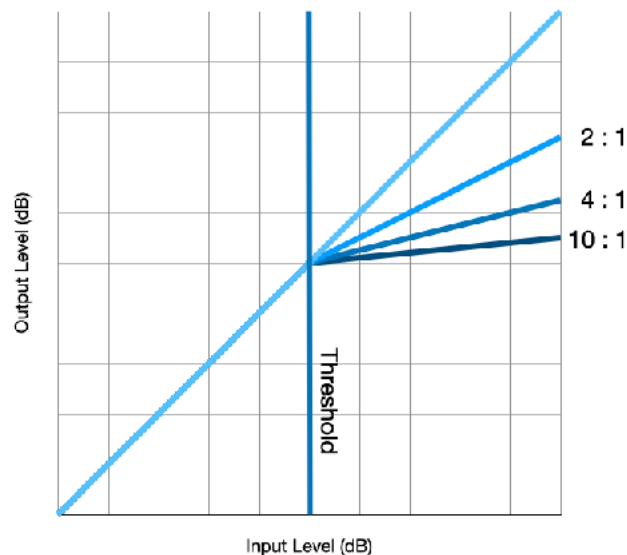

---

## Attack and Release

Attack is the time it takes for the signal to be compressed by the given ratio. Release is the time it takes the gain reduction to return to zero.

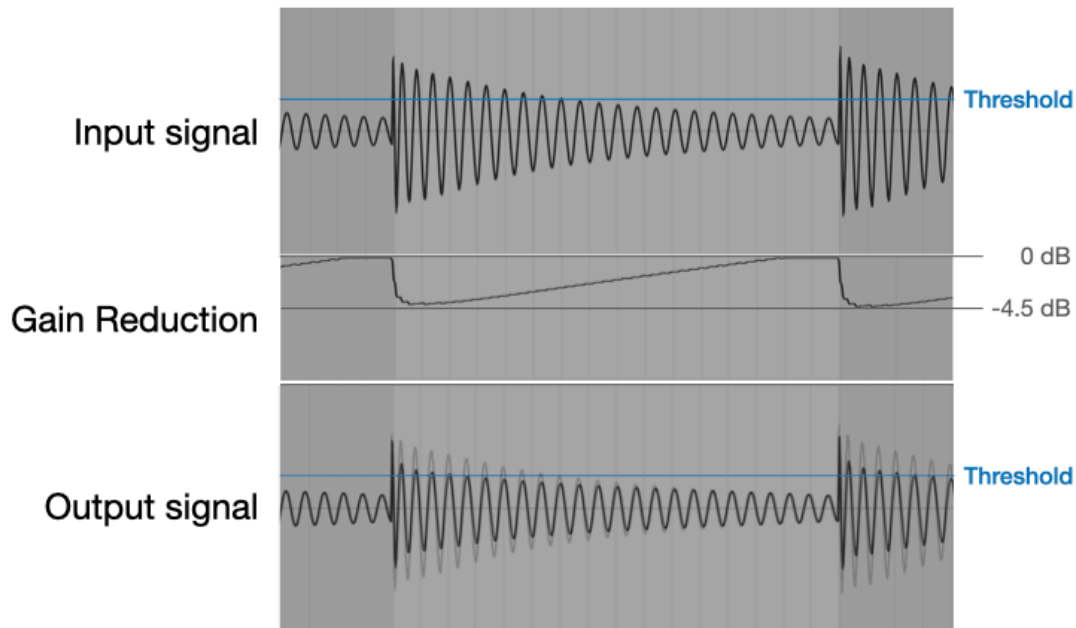

In this example, attack is 1 ms and release is 0.6 s. The initial transient pass through the compressor without gain reduction. It takes a while for the gain reduction to return to 0 dB after the input signal goes below the threshold.

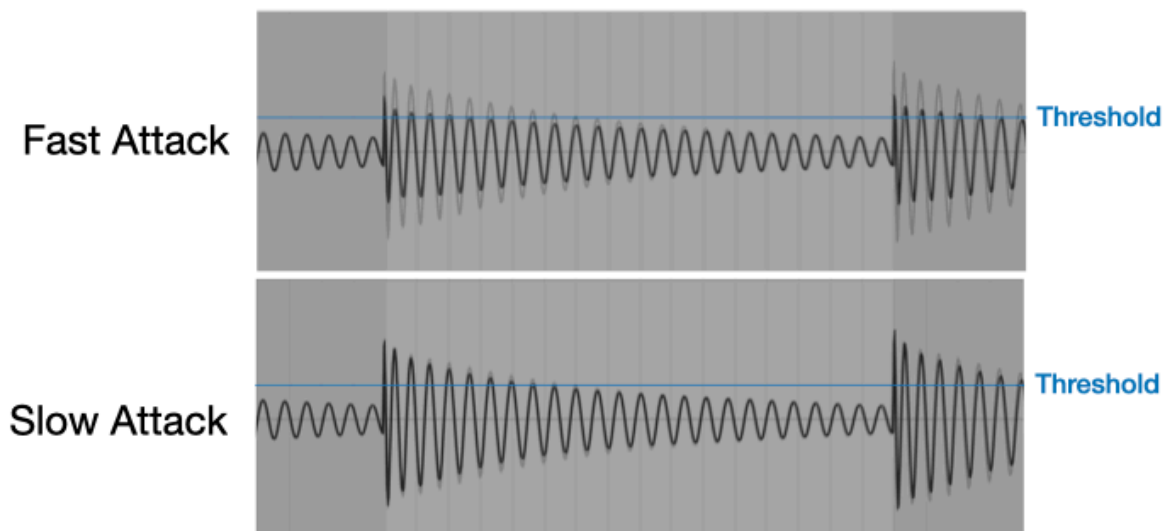

Fast attack makes compressor to start gain reduction immediately after the input signal passes above the threshold. Slow attack, on the other hand, allows many of the transients to pass through compressor without gain reduction.

The figures below illustrate characteristic of the attack and the release. 1KHz Sine wave is used as an input signal (shown as transparent background images). It shows how compressor reacts with various combination of the attack and release settings.

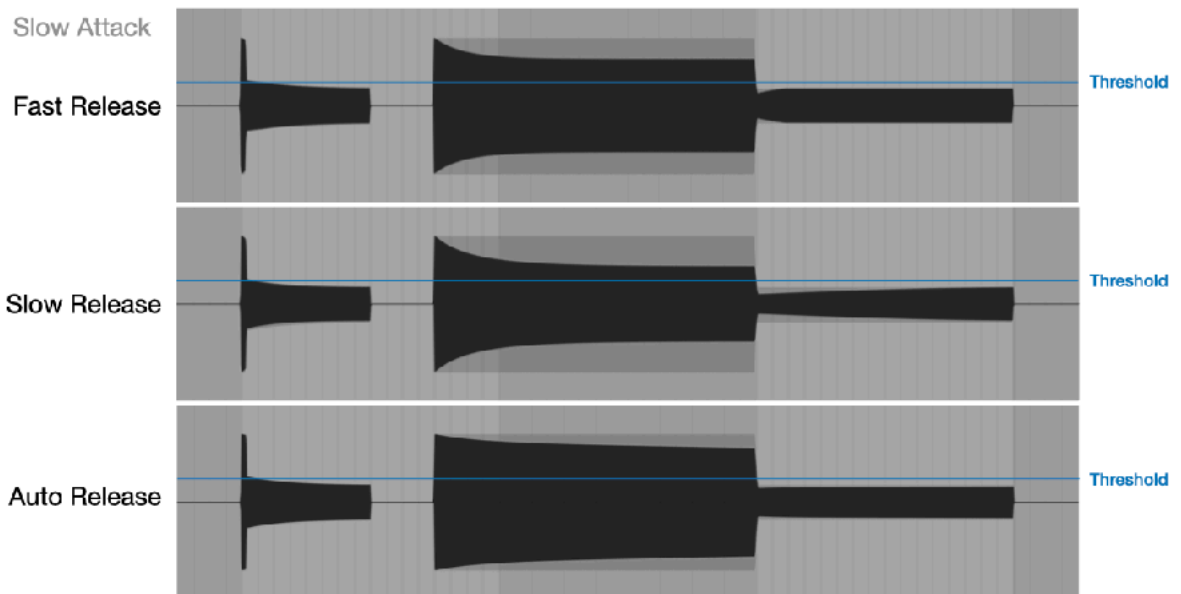
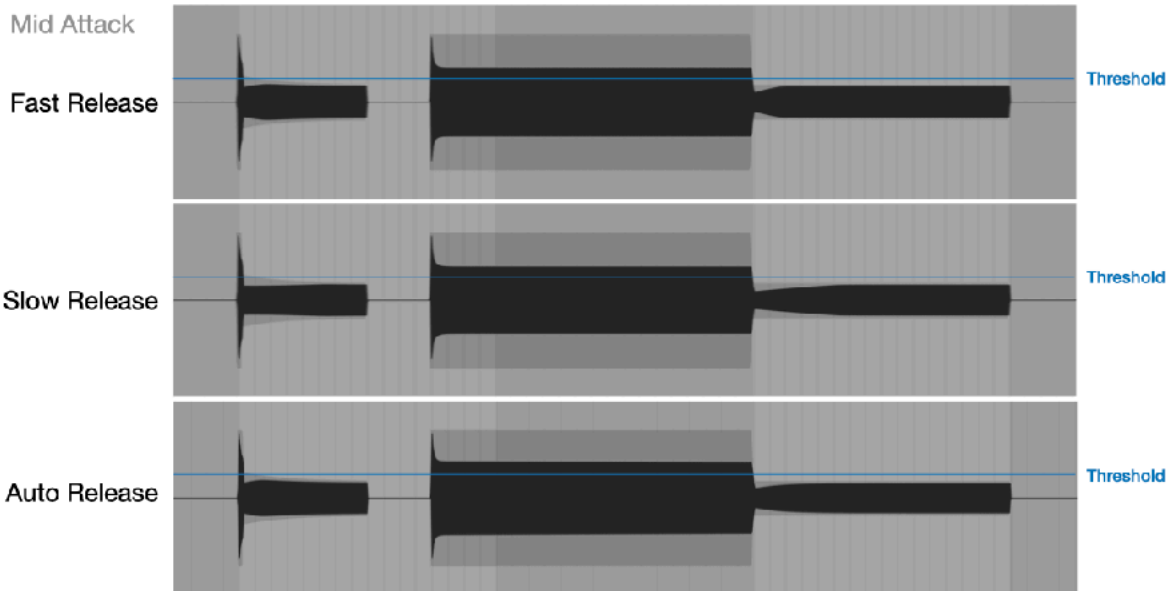
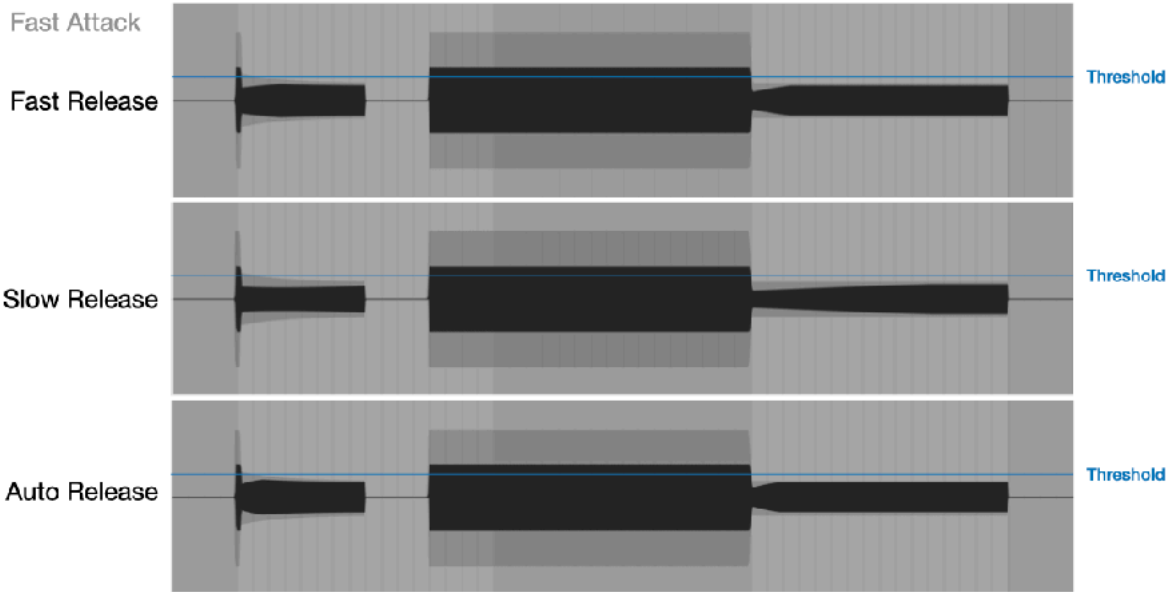

Auto Release uses two time constants for the peak detector. It will react differently for the short transients and the long sustained sound.

Fast attack reduces the level of the transients and make sound soft, slow attack allows transients to pass through and gives a punch to the sound.

Fast release causes pumping and breathing effects. Slow release continues to reduce level for a long period of time after compressing louder part of the sound.

---

## Side Chain High Pass Filter

-6 dB / octave high pass filter is applied to the input signal of the side chain. Frequency range is from 20 Hz to 185 Hz. This filter removes low frequency information from the input signal for the level detector to control excessive gain reduction and pumping effect.

---

## Makeup Gain

Use Makeup to compensate the gain reduced by the compressor. The range is from 0 dB to 20 dB. Gain reduction meters show the amount of the gain reduction. You can use the information to adjust level of the makeup gain.

---

## Gain Reduction Meter

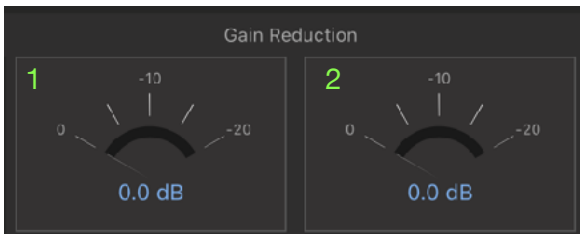

Gain reduction meters show peak level of the gain reductions in dB.

1. Gain reduction for the left channel
2. Gain reduction for the right channel

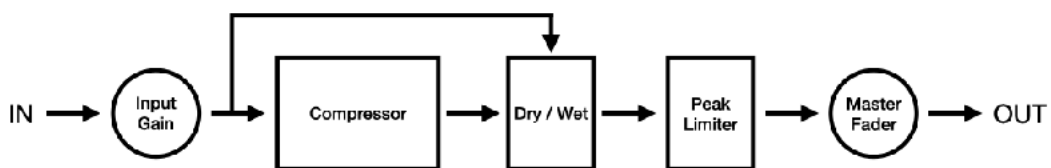

---

## Input Gain

Adjust gain of the input signal routed to the compressor. The range is from -20 dB to 20 dB. When level of input signal is increased, GR meters show gain reductions even if threshold is set to 0 dB.

---

## Dry / Wet

Use Dry / Wet to mix uncompressed signal (dry) and compressed signal (wet). Parallel compression technique, also known as New York compression can be achieved by adjusting amount of the wet signal mixed with the dry signal. When set to 0%, output is the dry signal. When set to 100%, output is the wet signal. When set to 50%, equal amount of the dry and the wet signal are mixed for the output.

---

## Peak Limiter

Peak Limiter is an analog style limiter and provides clean sounding output signal. This limiter is not a lookahead brick wall limiter, so that it can't offer brick wall limiting. However it does not introduced any latency to the output signal.

Frequency response of the peak limiter is illustrated in the figure below. Output signal shows the result of 1 dB gain reduction.

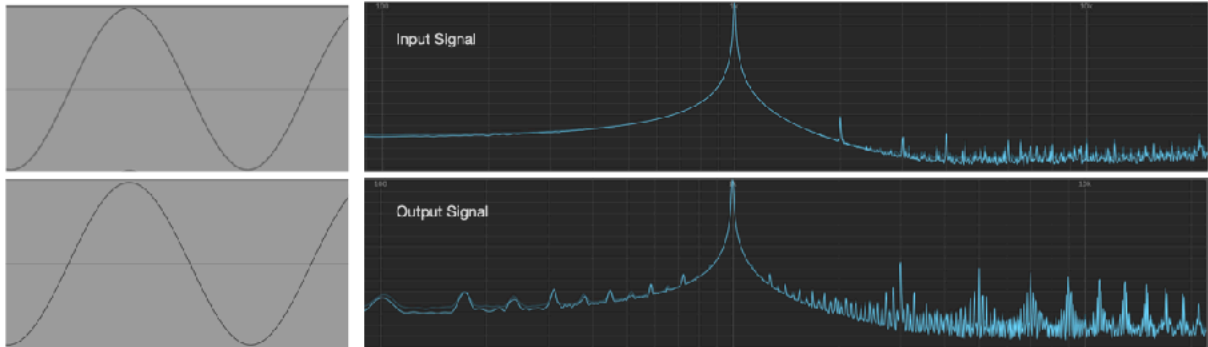

# Key Pad

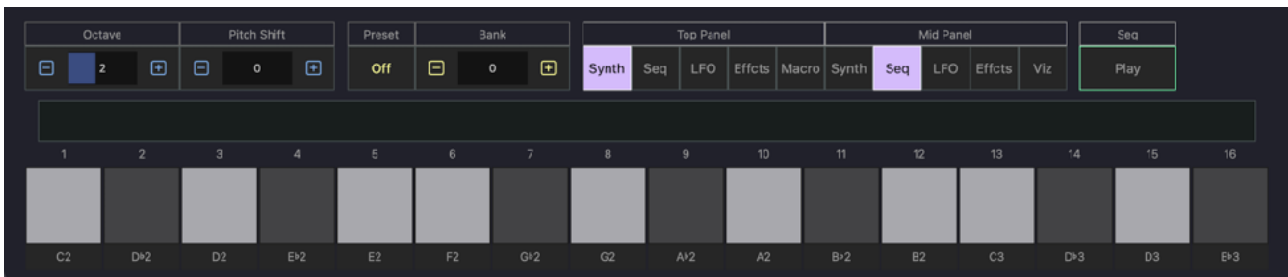

## Select Keyboard

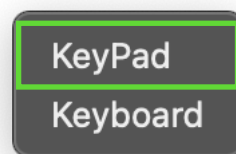

Hold this button (right click on macOS) to show keyboard menu. Select KeyPad. Tap the button in tool bar to show key pad.

## Select Octave

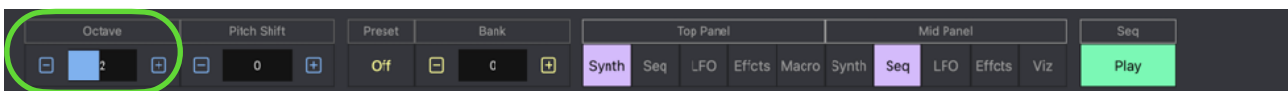

Use plus / minus buttons to adjust octave range of the key pad. Indicator shows octave of the lowest note of the key pad.

## Select Pitch Shift

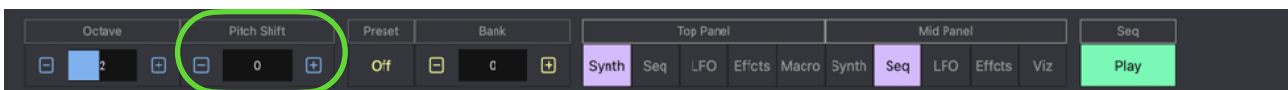

Use plus / minus buttons to adjust pitch range of the key pad.

## Select Preset Type

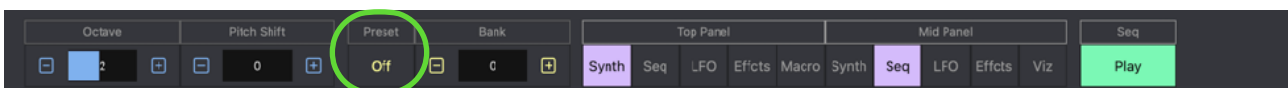

Select a preset type. Options are Off, Factory and User. When factory or user is selected, tap on key pad to select a preset. Play note indicated below the key pad from external keyboard also can select a preset.

---

## Select Preset Bank

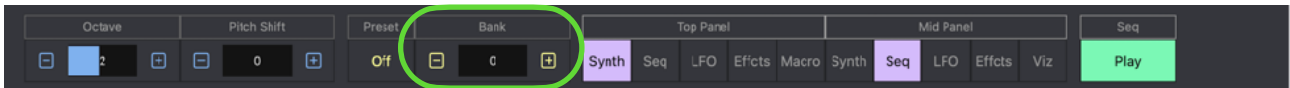

Use plus / minus buttons to select a preset bank. Preset number is sum of the key pad number and bank number \* 16. When triggered from external keyboard or sequencer, pitch also changes. This feature is ignored when exporting audio.

---

## Select Top Panel

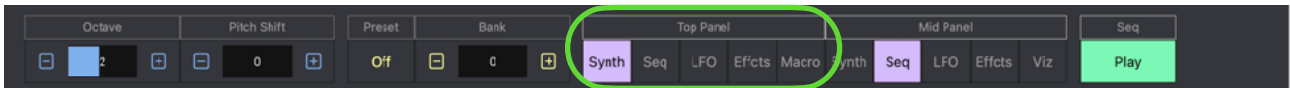

Select a module for the top panel.

---

## Select Mid Panel

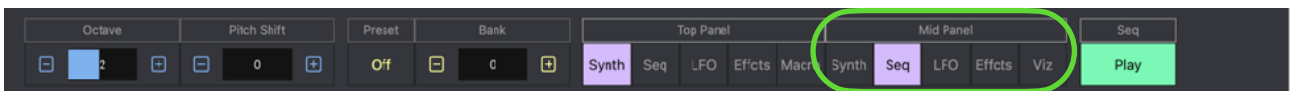

Select a module for the mid panel.

---

## Enable Play Switch for Step Sequencer

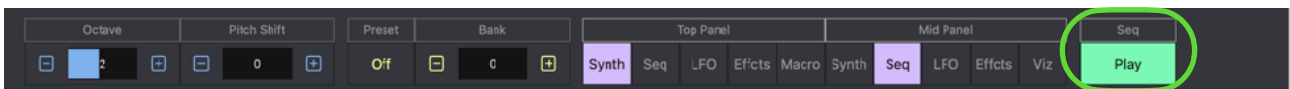

Turn it on to enable sequencer for playing. Tap any key on key pad to start the sequencer.

---

## Ribbon Controller



Dragging the Ribbon Controller applies linear pitch bend.

# Keyboard

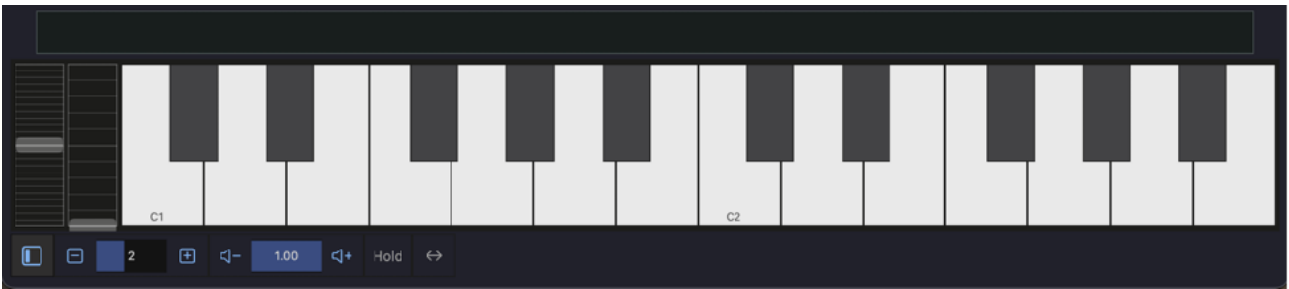

## Select Keyboard



Tap keyboard button in tool bar to show keyboard.

## Select Key Range

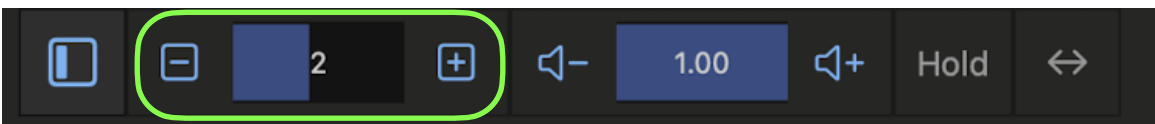

Use plus / minus buttons to adjust range of the keyboard. Indicator shows lowest note of the keyboard.

## Use Modulation Wheel

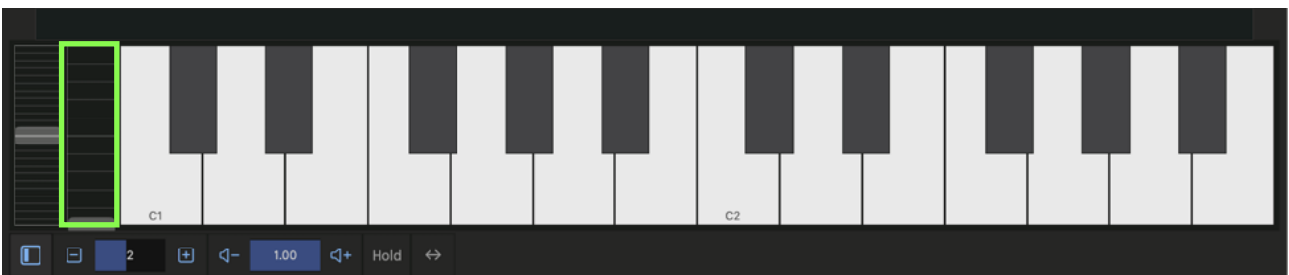

Adjust amount of the modulation when Mod Wheel is selected in modulation source.

## Use Pitch Wheel

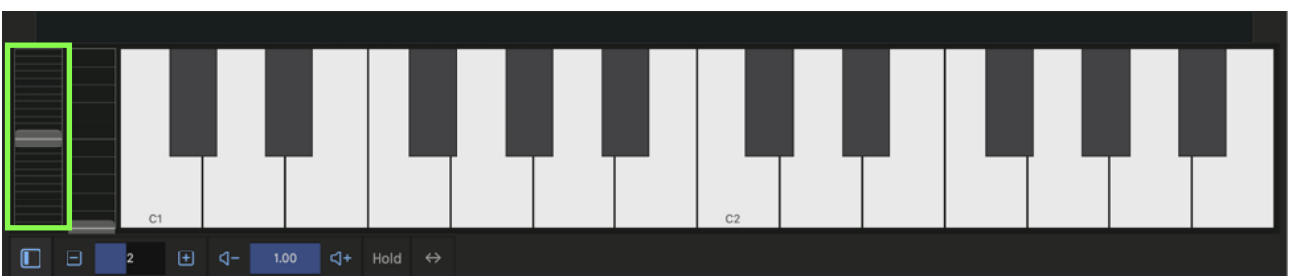

Adjust pitch of the oscillators. Range is plus / minus one octave.

---

## Set Velocity

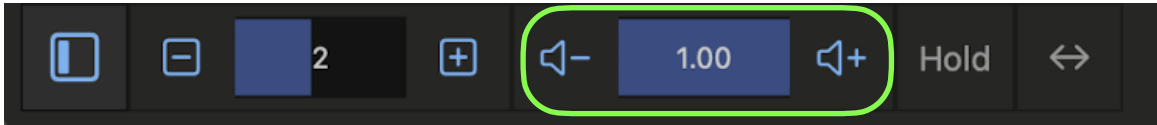

Use plus / minus buttons to adjust velocity.

---

## Use Key Hold

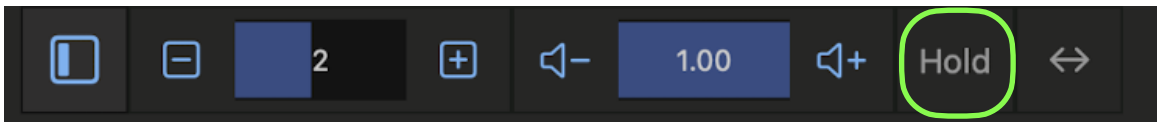

Tap to Enable/Disable Key Hold.

---

## Scroll Keyboard

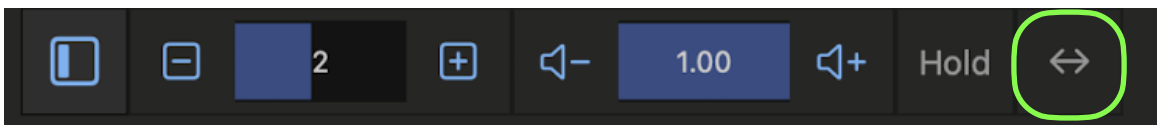

Tap this button to enable/disable keyboard scrolling.

---

## Ribbon Controller

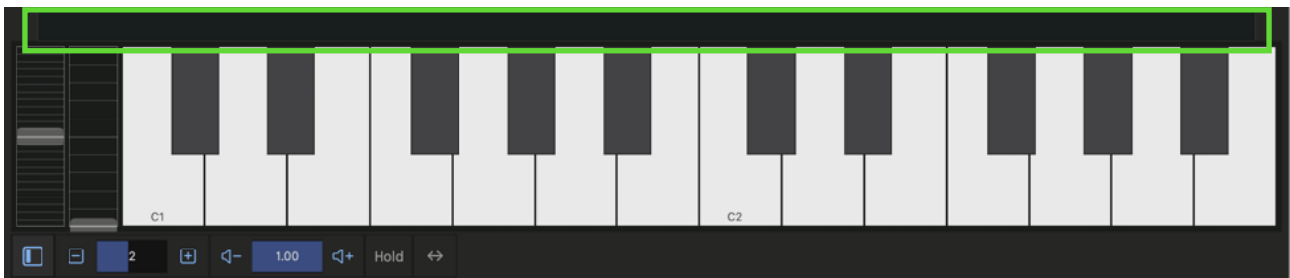

Dragging the Ribbon Controller applies linear pitch bend.

# Assignable Controllers

Tap synth button to show synth menu. Select Macro to show Assignable Controllers (Macro).

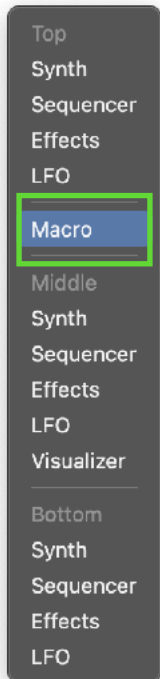

Tap Macro button in KeyPad to show Assignable Controllers (Macro).

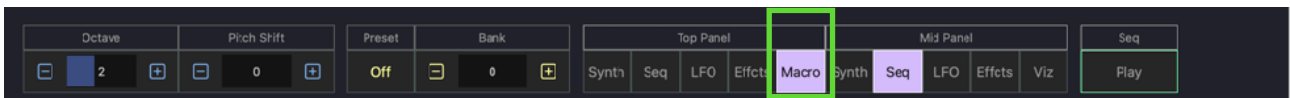

Tap "Assign" button and tap on a selected control to assign the parameter to the control.

## Macro Factory Presets

Five factory presets, Synth, VCA\_Mod&EFX, CF\_Mod, ChannelStrip and Effects, can be used to set parameters to Assignable Controllers.

# Sequencer (Piano Roll)

Enable Piano Roll Sequencer in setting panel to show piano roll sequencer.

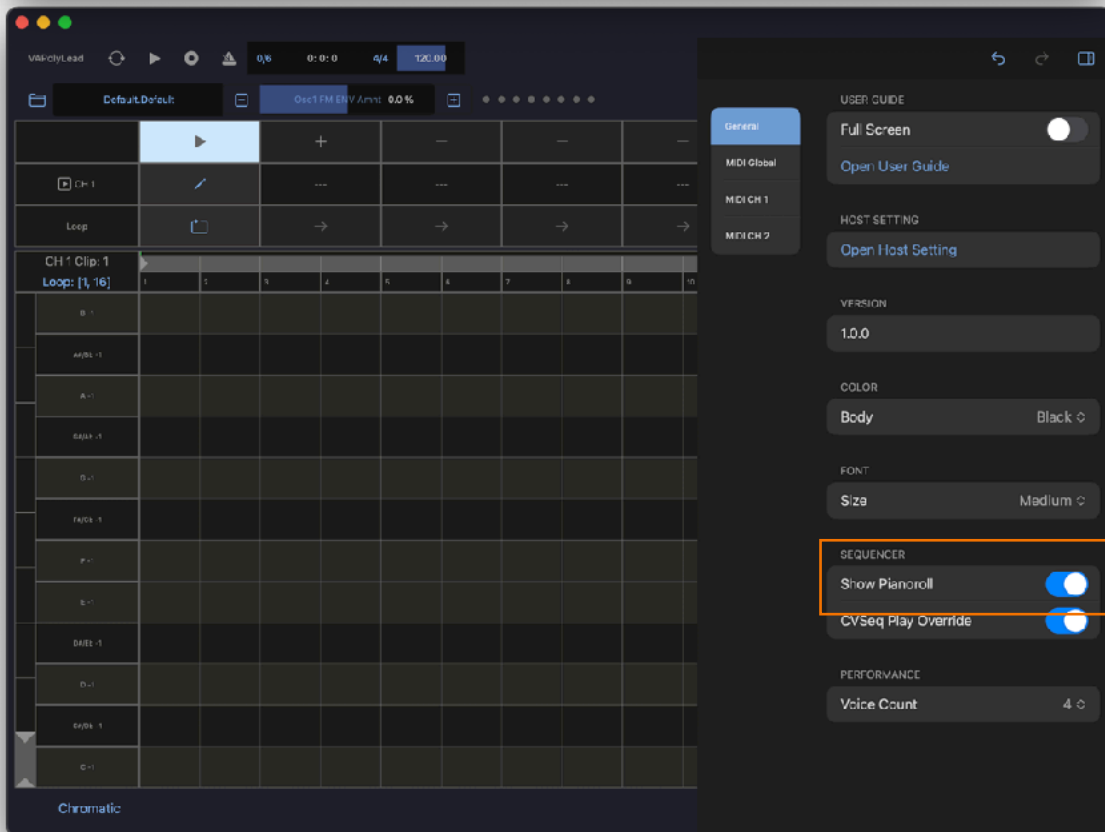
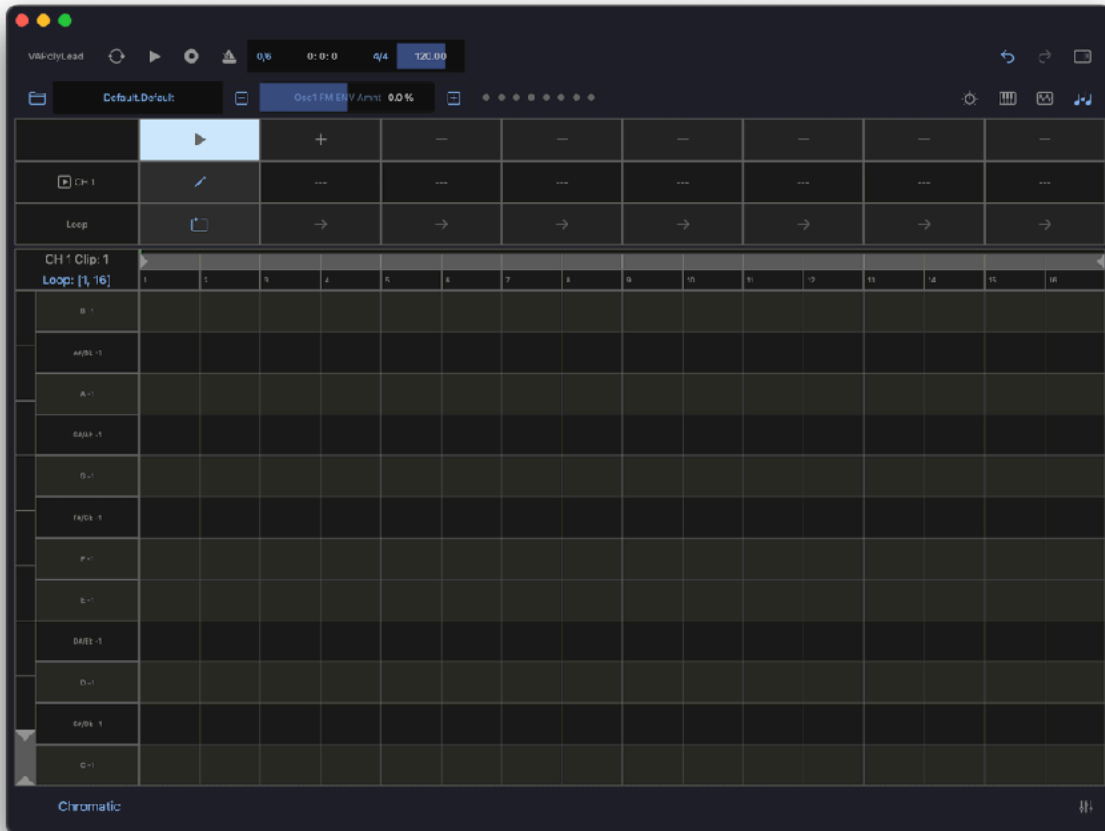

## Clip Editor



Each clip contains note event and parameter automation events for length of 16 bars. Maximum number of clips are 8.

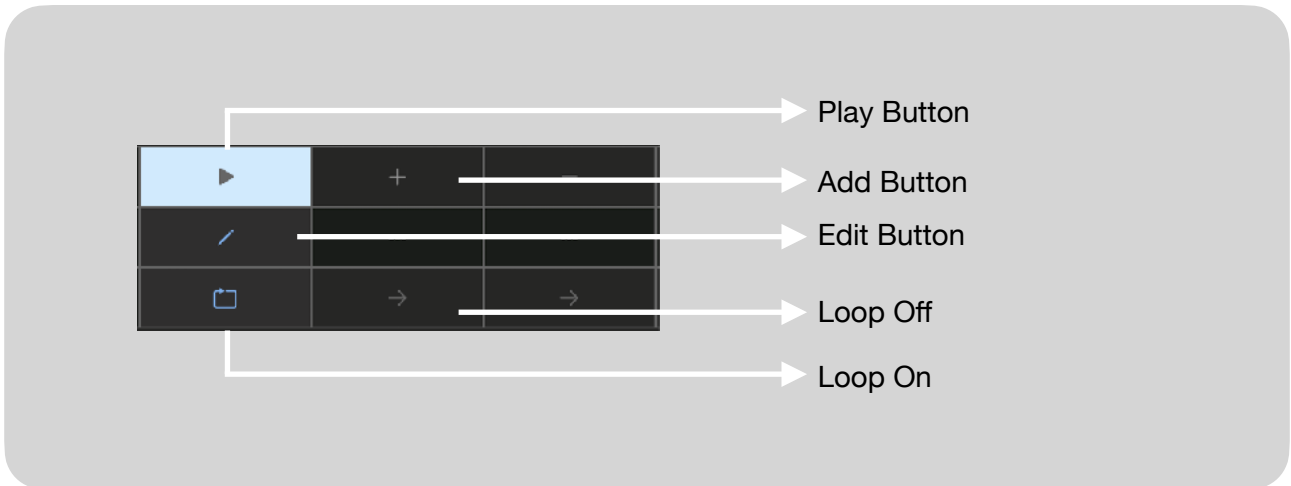

---

### Load Clip

Tap load button to load clip to make it active.

---

### Play/Stop Clip

Tap play button to play/stop clip.

---

### Edit Piano Roll

Tap edit button to open piano roll editor.

---

### Add edit button

Tap plus button to add edit button.

---

### Set Loop Mode

Tap this button to enable/disable loop mode. When loop is off, tap square icon to select a clip to play next.

---

### Auto Select Editor

Tap Synth Row Label to toggle Auto Select Editor Switch. When Auto Select is enabled, editor changes while playing sequence.

# Piano Roll Editor

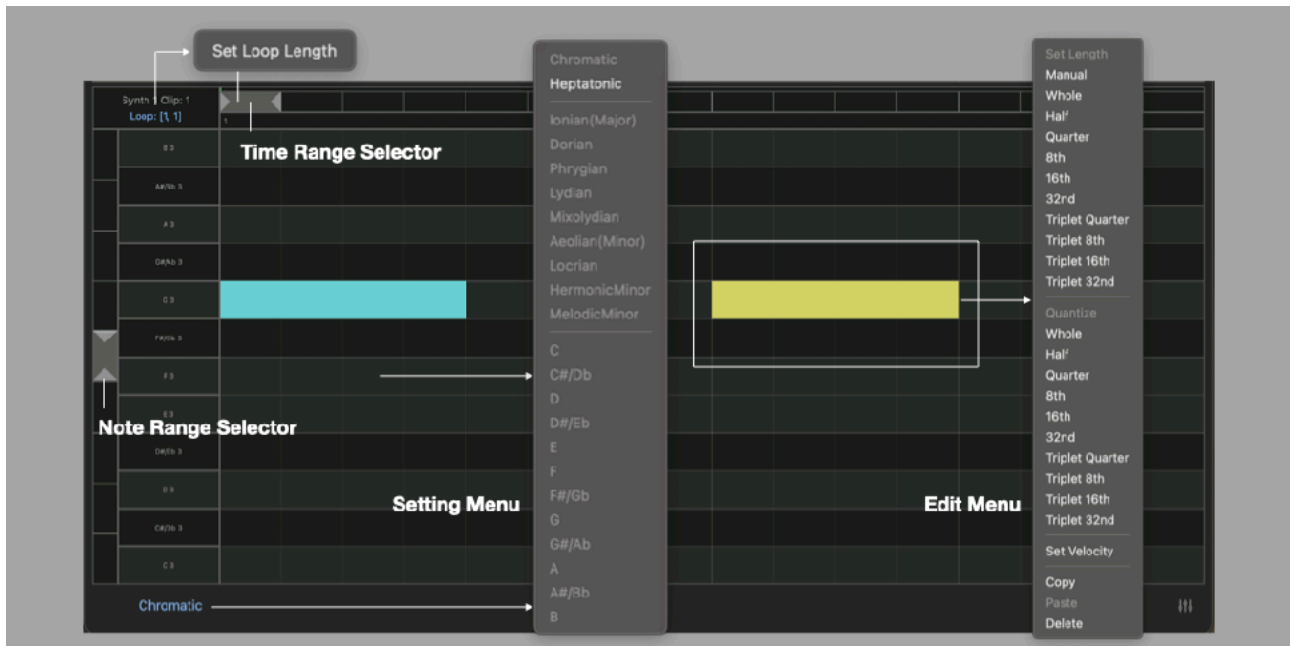

---

## Select Time Range and Loop Length

Use “Time Range Selector” to select Time Range for editing and Loop Length. On iOS, pinch gesture control zooming and drag gesture control scroll position.

To set Loop Length, tap on Loop Length button to show menu and select “Set Loop Length”. Right click on selector on Mac also show the menu.

---

## Select Note Range

Use “Note Range Selector” to select note range for editing. On iOS, pinch gesture control zooming and drag gesture control scroll position.

---

## Add Note

Double tap to add a note.

---

## Delete Note

Select note and select Delete from context menu.

---

## Scale Menu

Press and hold (right click on macOS) editor to show scale menu. Tap on scale button also shows the menu.

---

## Edit Menu

Press and hold (right click on macOS) selected note to show edit menu.

- Chromatic
- Heptatonic**

---

- Ionian(Major)
- Dorian
- Phrygian
- Lydian
- Mixolydian
- Aeolian(Minor)
- Locrian
- HermonicMinor
- MelodicMinor

---

- C
- C#/Db
- D
- D#/Eb
- E
- F
- F#/Gb
- G
- G#/Ab
- A
- A#/Bb
- B

---

### Chromatic Scale

Select Chromatic to edit notes in Chromatic Scale (12 tones).

---

### Heptatonic Scale

Select Heptatonic to edit notes in Diatonic Scale, Harmonic Minor Scale or Melodic Minor Scale (7 degrees).

---

### Root Key

Select a root key, when editing note in Diatonic Scale, Harmonica Minor or Melodic Minor Scale.

- Set Length
- Manual
- Maximum
- Whole
- Half
- Quarter
- 8th
- 16th
- 32nd
- Triplet Quarter
- Triplet 8th
- Triplet 16th
- Triplet 32nd
- Quantize
- Whole
- Half
- Quarter
- 8th
- 16th
- 32nd
- Triplet Quarter
- Triplet 8th
- Triplet 16th
- Triplet 32nd
- Hide Velocity
- Copy
- Paste
- Delete

---

## Set Length

Select an option to set note length.

---

## Quantize

Select an option to quantize note.

---

## Set Velocity

Open velocity editor to edit note velocity.

---

## Copy

Copy selected notes.

---

## Paste

Paste notes.

---

## Delete

Delete selected notes.

## Velocity Editor

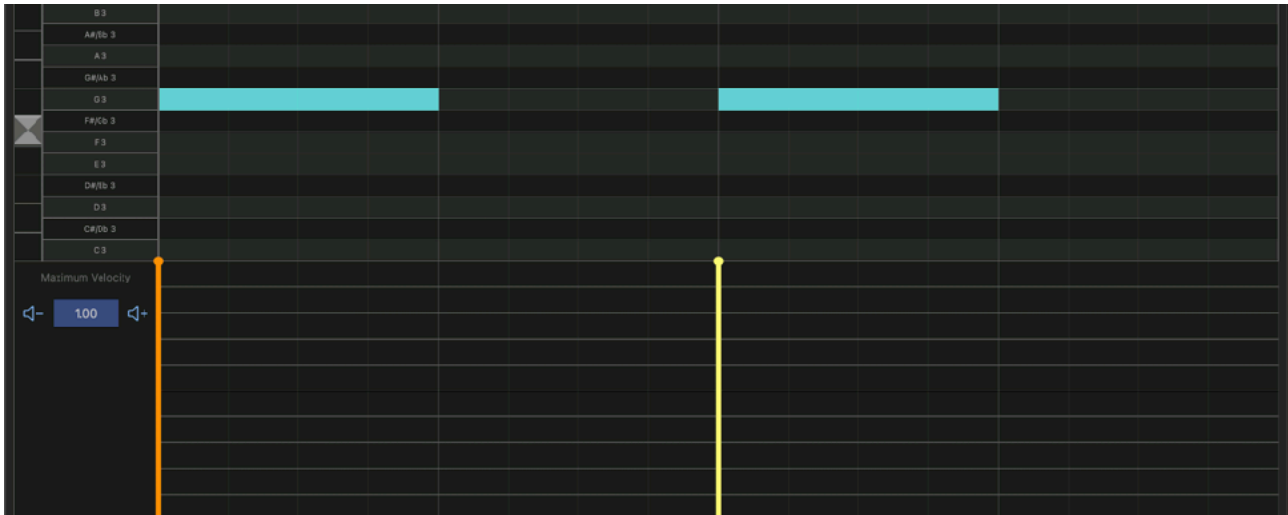

1. Select a note and open context menu.
2. Select "Set Velocity" in context menu
3. Select velocity sliders and adjust the velocity. Indicator in side bar shows maximum velocity in the selection. Maximum velocity value can be adjusted by plus and minus button and slider of the indicator.

# Parameter Automation Editor

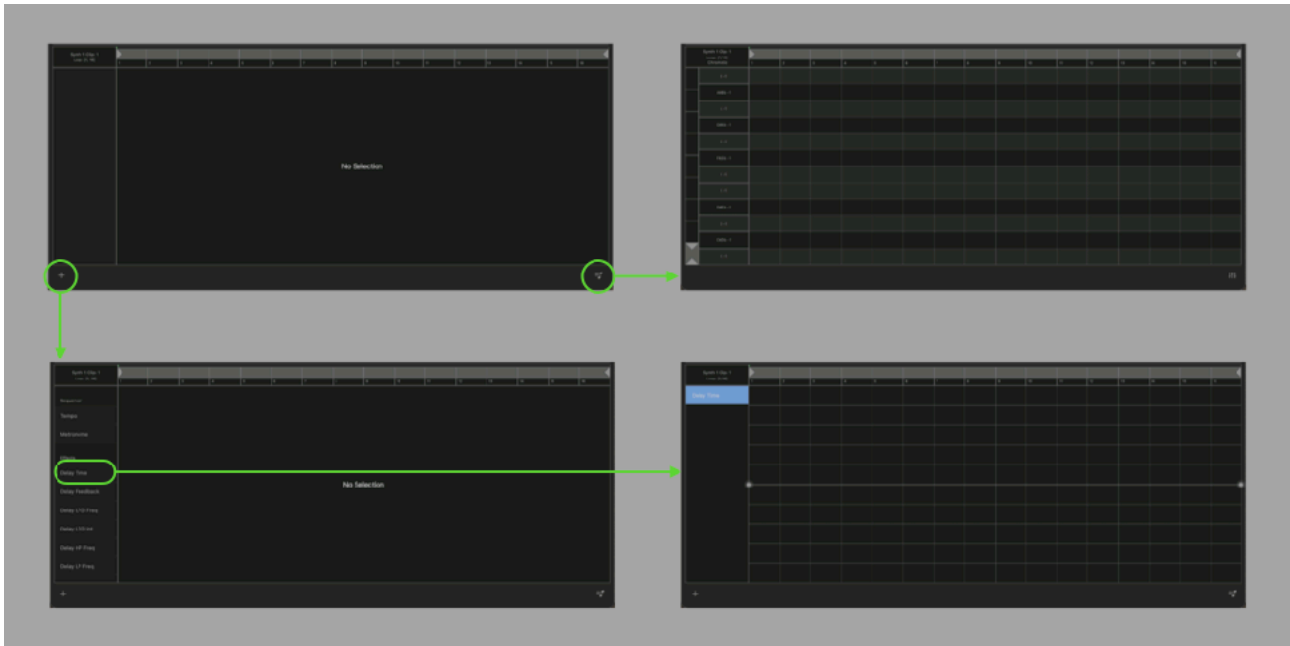

1. Tap plus button to show parameter list.
2. Select a parameter to edit.
3. Press and hold (right click on macOS) on parameter name to show context menu. Tap Delete to delete the parameter form editor.

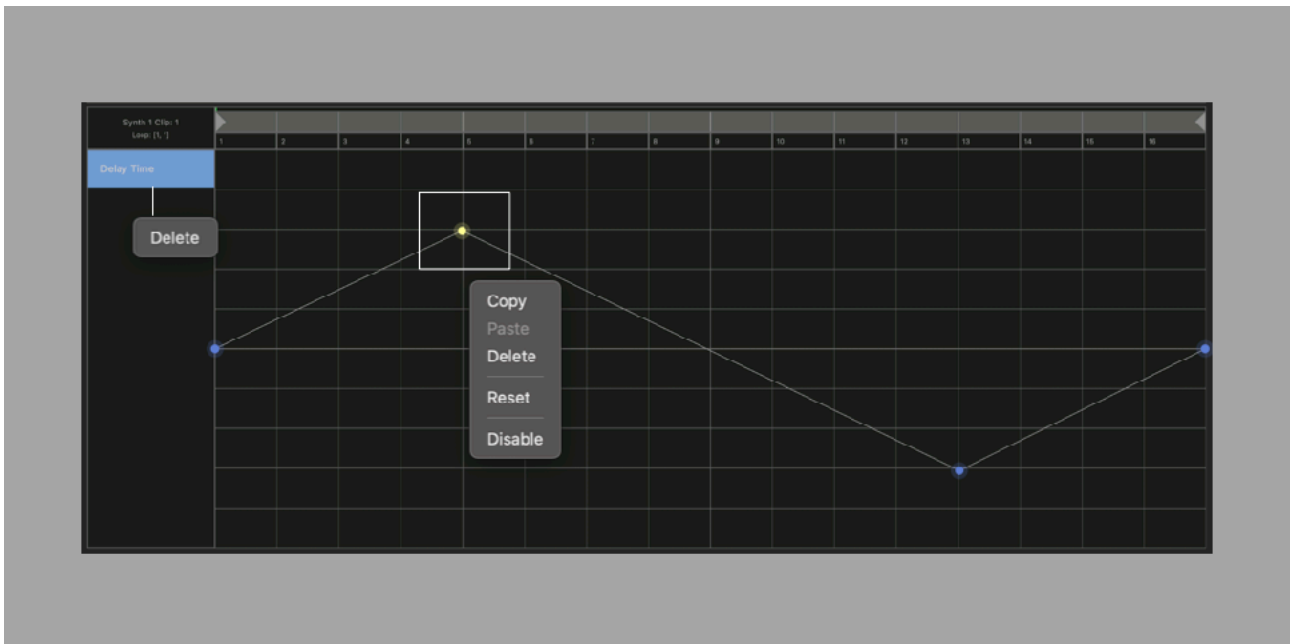

4. Double tap to add an edit point.
5. Select edit points and press and hold (right click on macOS) on editor to show context menu.
6. Select Reset from context menu to reset the parameter.
7. Select Disable to inactivate automation.

# Play Sequence

---

## 1. Set host sync

Tap sync button in transport bar to enable / disable sync mode.

When sync mode is enabled,

### Stand Alone

Sequencer is synced to the clock provided by container application. The container application can use Ableton Link to synchronized with the Link enabled devices. Use buttons in transport bar to play / stop sequence and change tempo.

### Plugin

Sequencer is synced to the clock provided by the host application. Use transport switches of the host application to play / stop the sequence and change tempo.

When sync mode is disabled,

Sequencer is driven by internal clock. Use buttons in transport bar to play / stop the sequence and change tempo.

---

## 2. Set tempo

Tap plus / minus button at the tempo section in the transport bar to open tempo slider. Tempo can be adjusted by the plus / minus buttons and the tempo slider. Tempo slider can adjust tempo by range of plus/minus 20 BPM. Double tap on the slider set center position to the current tempo value. Alternatively tapping on tempo indicator allows you to type in tempo value by computer keyboard.

---

## 3. Set loop

Use Time Range Selector to set loop length.

---

## 4. Set swing

Tap swing button in transport bar to show swing menu. Select an option from the menu to apply the swing.

Swing Type	Delay time	Duration (Ratio)	Note
Swing 0/6	0 (no swing)	50%	Straight
Swing 1/6	1/6 of 16th note	54%	Soft swing
Swing 2/6	2/6 of 16th note	58%	Soft swing
Swing 3/6	3/6 of 16th note	62%	Soft swing
Swing 4/6	4/6 of 16th note	66%	Triplet swing
Swing 5/6	5/6 of 16th note	70%	Hard swing
Swing 6/6	16th note	75%	Dotted hard swing

Delay time is an amount of delay applied to the third 16th note when a beat is divided by four 16th notes.

Duration (ratio) is a ratio of duration from the first 16th note to the third 16th note when a beat is divided by four 16th notes.

Amount of delay for the notes in a beat changes proportionally.

---

## 5. Set metronome switch

Tap metronome button in transport bar to enable / disable metronome.

---

## 6. Play

Tap play / stop button in transport bar or transport switches of the host application to play / stop the sequence.

# Record Sequence

---

## 1. Set recording mode

Tap record button in transport bar to enable recording mode.

---

## 2. Play sequence

Play the sequence by following the steps described above. Recording will start after count-in. When tap recording button while playing, recording start without count-in. To start recording without count-in, play sequence first then tap record button.

---

## 3. Record notes

Play keypads or MIDI keyboard to record notes. Notes are automatically quantized at 16 step position.

---

## 4. Record parameters automation

Before recording parameter values, use edit command “Reset to Dial Value” to reset values of the parameter to the rest position.

Turn a dial or switch to record the parameter values. The color of the control changes to green to indicate the parameter is recorded. The control won't move automatically until disabling the recording mode in order to move the control freely during the recording.

If the synth or the effects is not producing sound, parameter value will not be recorded.

---

## 5. Stop recording

Tap record button in transport bar to disable recording mode or tap play button to stop playback.

## Preset

User Preset contains values of the synth parameters and the sequence data. When loading a user preset, value of the synth parameters and the sequence data are both changed. User Presets can be saved in iCloud Drive or in AUv3 plug-in on the device.

To save user preset in iCloud drive, select Save in File Menu. User Presets in iCloud Drive can be accessed from iPhone, iPad or Mac.

To save user preset in plug-in, tap Add button in Preset Browser. Plug-In Preset is stored on the device and can be accessed from any host application which support AUv3 User Preset.

Factory presets contains only values of parameters of the synth and the effects. It doesn't contain any sequence data. When loading the preset, it will change the value of the parameters but sequence data remains the same.

To load factory presets, select a preset in Preset Browser.

## File Menu

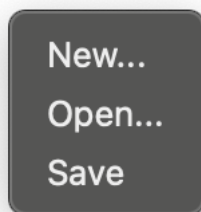

---

### New...

Reset parameters and sequence data.

---

### Open...

Open a preset from iCloud drive.

---

### Save

Save a preset in iCloud drive.

# Preset Browser

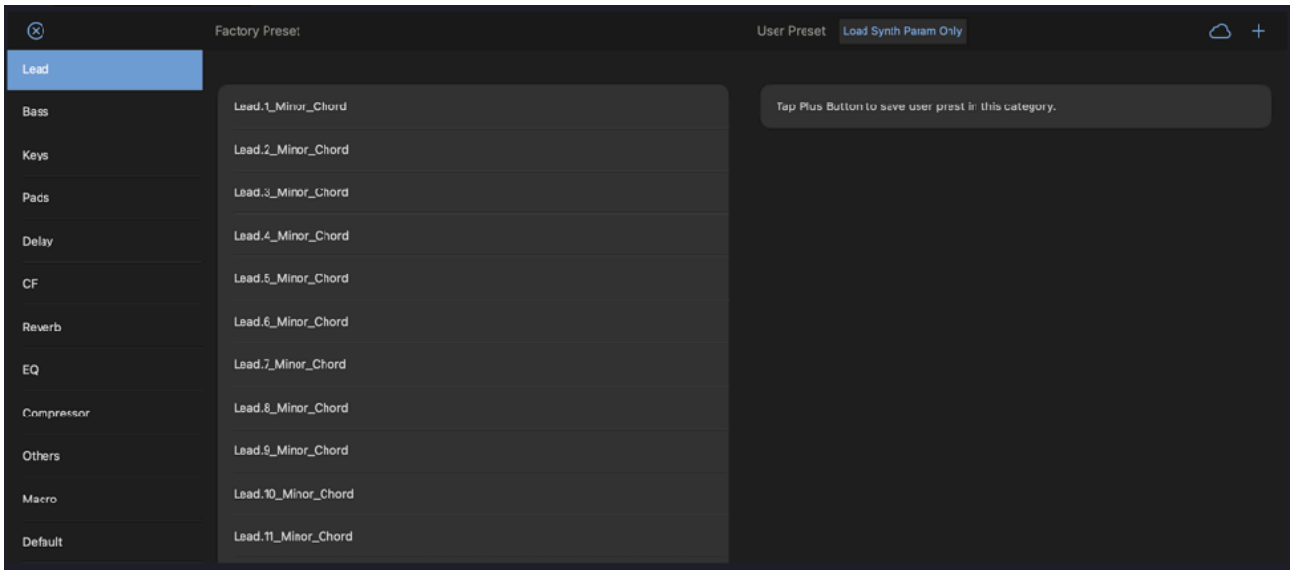

---

## Load Factory Preset

Select a category from a list in the side bar. Tap on the name of the preset in Factory Preset Section to load.

---

## Load User Preset

Select a category from a list in the side bar. Tap on the name of the preset in User Preset Section to load. If “Load Synth Param Only” is on, only synth parameters will be loaded. If the option is off, synth param and sequencer data will be loaded.

---

## Delete User Preset

Tap and hold (right click on macOS) on the name of the preset in User Preset Section to show context menu and select Delete.

---

## Save User Preset

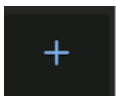

Select a category from a list in the side bar. Tap on plus button to add a user preset.

---

## Backup/Restore User Presets stored in the device



To back up or restore all user presets, tap on the iCloud icon to show export menu.

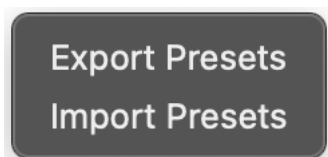

Select Export Presets to back up all of the user presets to iCloud.

Select Import Presets to import saved presets from iCloud.

---

## Close File Browser

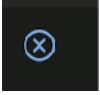

Tap on X icon to close the browser.

# Setting Panel

## General

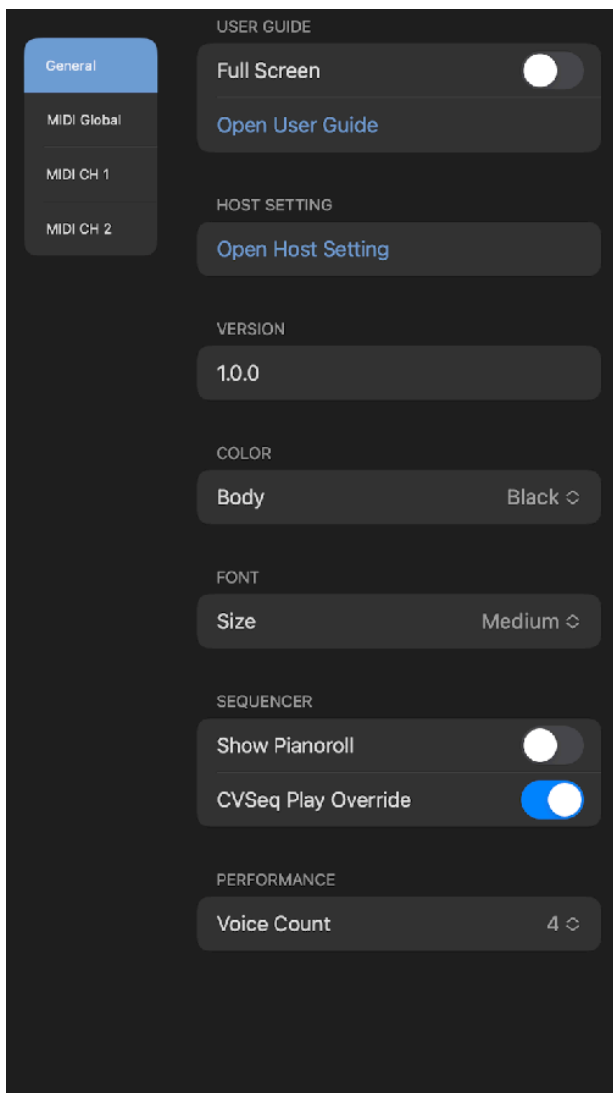

---

### Full Screen

Enable this option to open User Guide in full screen (full window size on macOS).

---

### Open User Guide

Tap this button to open User Guide

---

### Open Host Setting

Tap this button to open Stand Alone Settings

---

### Version

Indicate version number of the installed app.

---

### Color

Select color. Options are black, navy and gray.

---

### Font Size

Select text size of control title. Options are Small, Medium and Large.

---

### Show Piano Roll

Enable to show piano roll sequencer.

---

### CVSEQ Play Override

Enable CVSEQ Play override option.

---

### Voice Count

Set voice count.

# MIDI Global

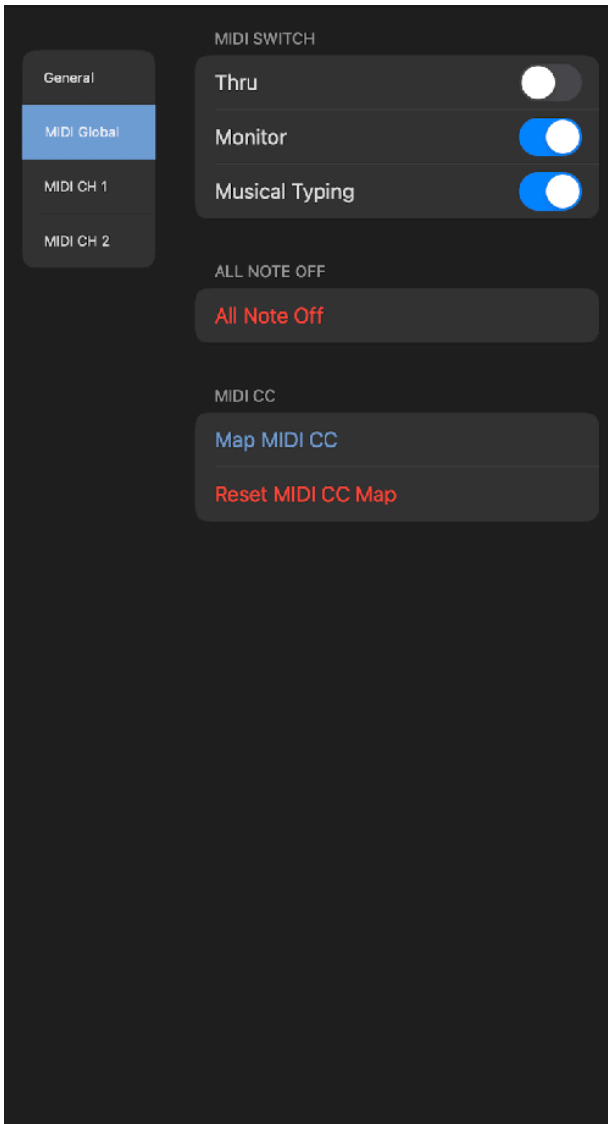

---

## MIDI Thru

When MIDI thru is turned on, MIDI messages received in MIDI input will be send out from MIDI output. This setting is required when connected device's local switch is turned off.

---

## MIDI Monitor

Enable / disable MIDI key input monitoring. Key Range of keyboard and sequencer is automatically adjusted based on the input note.

---

## Musical Typing

Enable / disable computer keyboard to play MIDI notes.

---

## All Notes Off

Send note off message to all notes.

---

## Map MIDI CC

Open or Close Map MIDI CC view.

---

## Reset MIDI CC Map

Remove all MIDI CC Map assignments.

# MIDI Synth

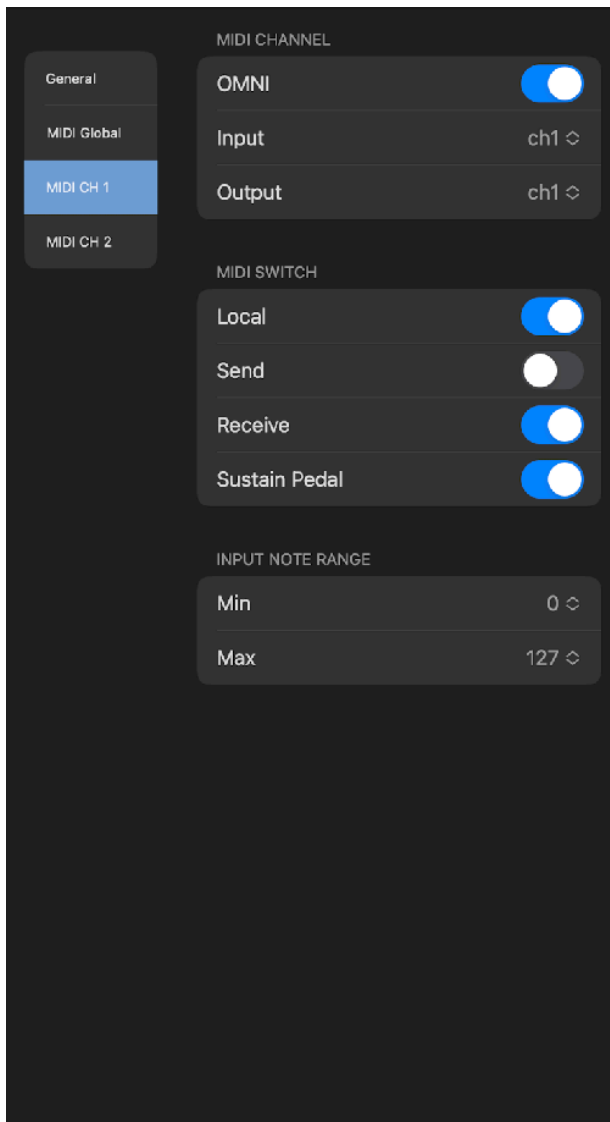

---

## OMNI

Turn this on to connect all channel.

---

## Input

Select input channel

---

## Output

Select output channel

---

## MIDI Local

When sending and receiving MIDI, connected device may send back the MIDI. This causes each notes to play twice. If this problem occurs, turn MIDI Local Switch OFF to disconnect User Interface from the audio engine.

---

## MIDI Send

Enable / disable MIDI output.

---

## MIDI Receive

Enable / disable MIDI input.

---

## Sustain Pedal

Enable / disable to receive Damper Pedal message (MIDI CC #64).

---

## Min

Set min value of MIDI note input.

---

## Max

Set max value of MIDI note input.

---

# Stand Alone Setting

## AbletonLink

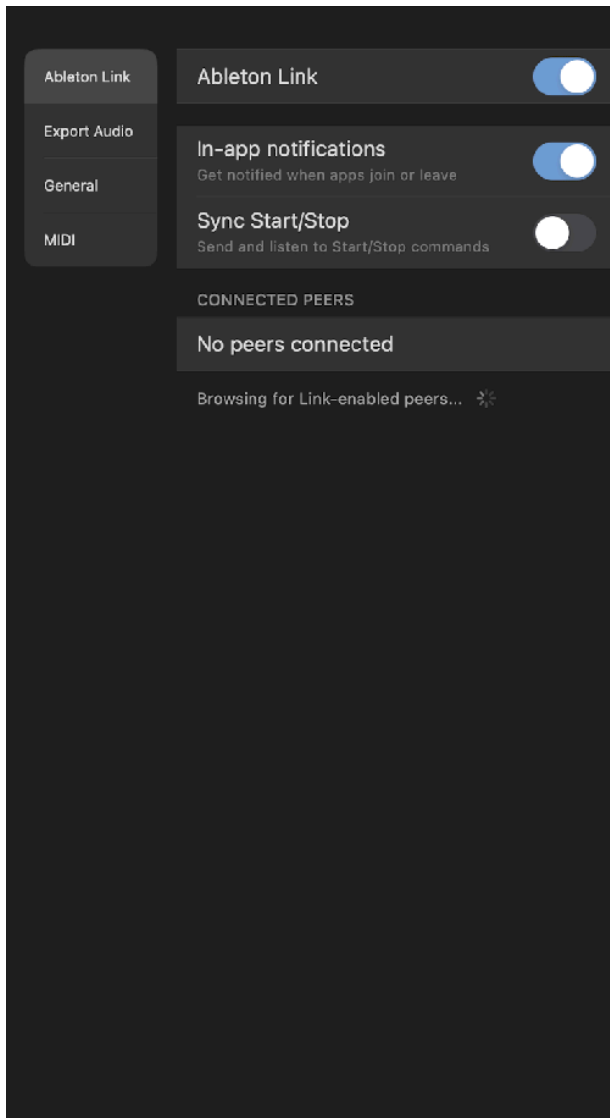

Ableton Link is a new technology that synchronizes beat, phase and tempo of Ableton Live and Link-enabled iOS apps over a wireless network. It lets you play devices together with the freedom of a live band. Anyone can start and stop their part while others keep playing, and anyone can adjust the tempo and the rest will follow. You can use Link to play with several instances of Ableton Live, with Live and iOS apps, or even without Live in your setup: using Link-enabled apps on multiple devices, or multiple apps on the same device.

---

### Ableton Link

Switch on to enable Ableton Link.

---

### In-app notification

Switch on to displays a message when an Ableton Link enabled app is connected.

---

### Sync Start/Stop

Switch on to synchronize start and stop with connected apps.

---

### Connected Apps

Indicate number of currently connected apps.

Ableton Link requires Wireless Local Network Connections. Your device and other Link-enabled devices must be connected to the same local network.

# Export Audio

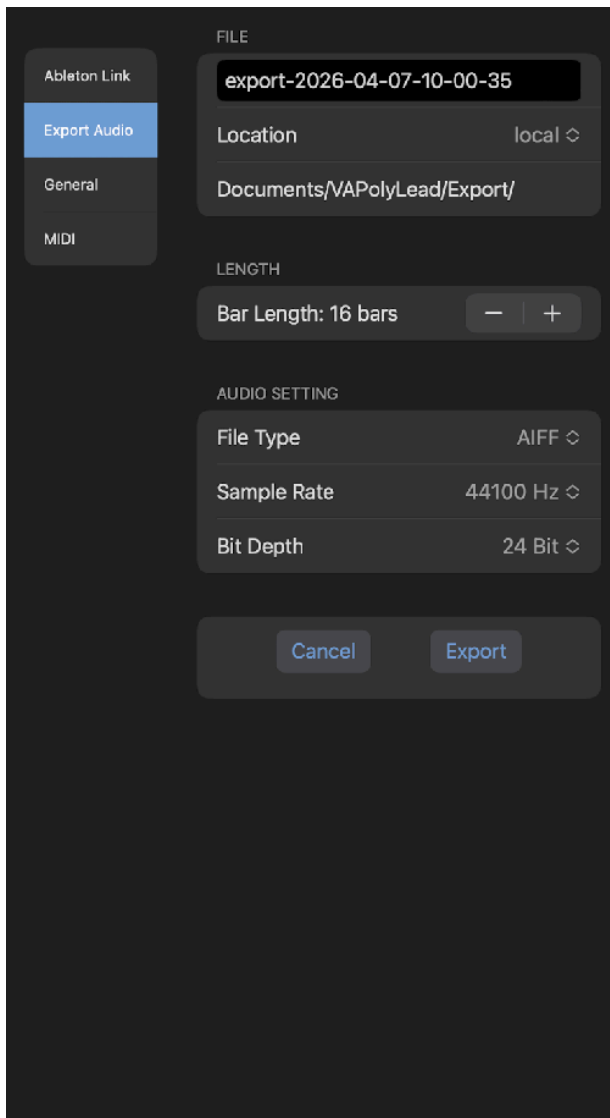

---

## Save As

Specify name of the audio file to export.

---

## Location

Select location for the audio file to be stored. Options are Local or iCloud.

---

## Length (Bars)

Length of the audio to be recorded. Specify the length by number of bars.

---

## File Type

Select file type of the audio file. Options are AIFF, WAV, CAF and ACC.

---

## Sample Rate

Select a sample rate of the audio file. Options are 44.1KHz, 48KHz, 88.2KHz and 96KHz.

---

## Bit Depth

Specify bit depth of the audio file. Options are 16 bit, 24 bit and 32 bit.

---

## Export

Tap export to export audio file.

---

## Cancel

Tap cancel to return to the home page of the setting panel.

# General

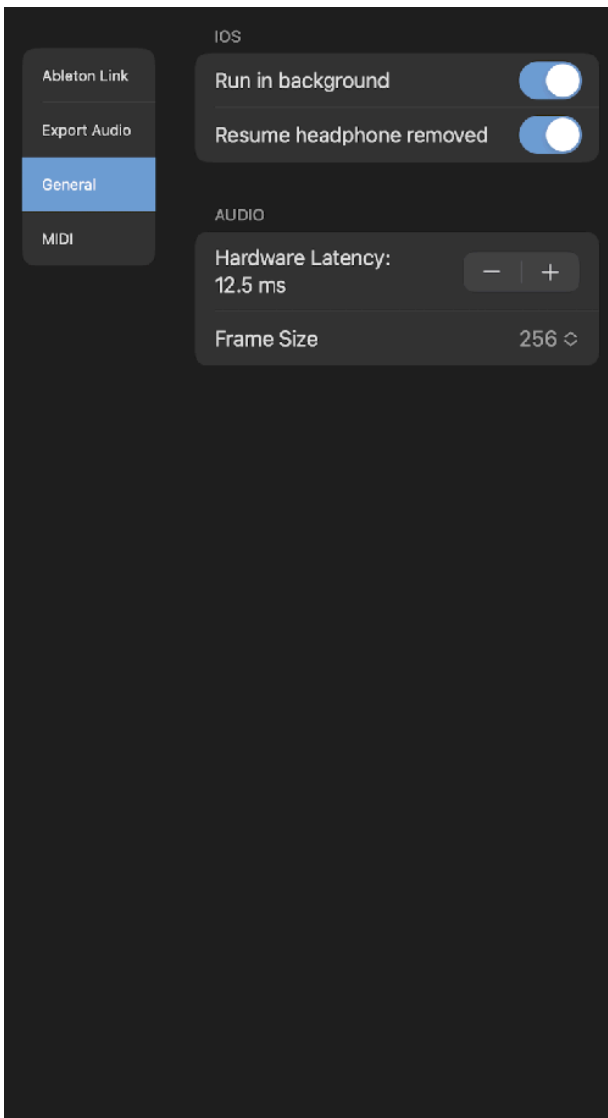

---

## Run in Background

Turn this switch on to allow app to play continuously when the app enters in the background.

---

## Resume Headphone Removed

Turn this switch on to allow app to play continuously when headphone is disconnected.

---

## Hardware Latency

When Ableton Link is enabled, playback is synchronized to the Link-enabled devices. If there is a latency, output signal may not be aligned with the beginning of the each step.

In order to adjust the latency, set time in milliseconds in Hardware Latency. This value is used to compensate the latency of the output signal.

The latency varies on audio Interface and sample rate. Default value is 12.5 millisecond (sample rate is 44.1KHz)

---

## Frame Size

Frame Size (Buffer Size) is a number of samples contained in an audio buffer. Higher frame size increases system performance but increases latency. Lower frame size decrease latency but decreases system performance. If you experience a problem with system performance, set higher frame size to improve the performance. Default setting is 256.

# MIDI

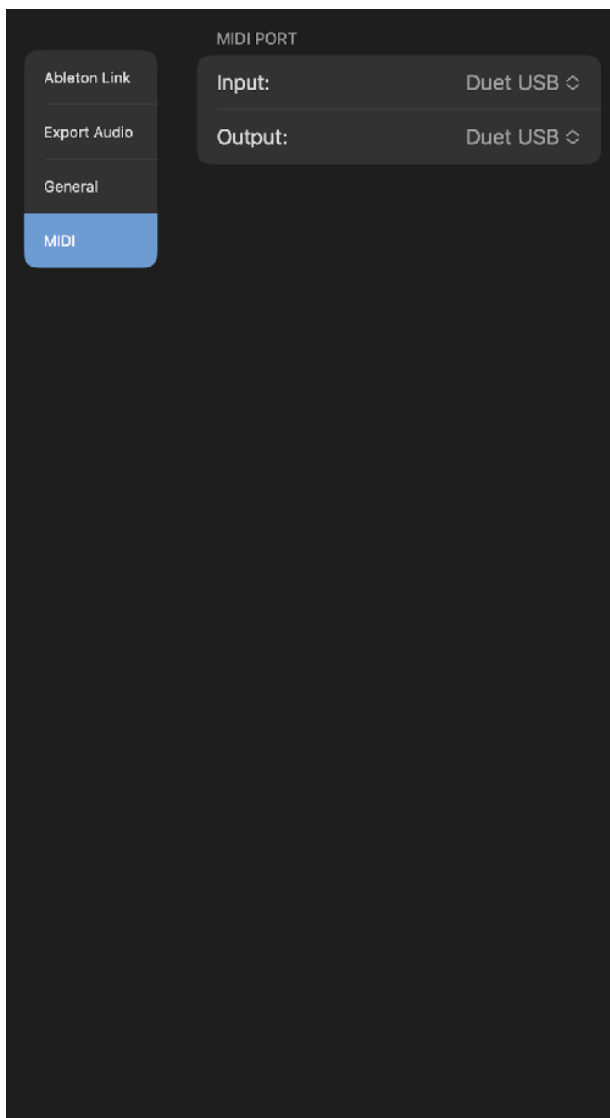

---

## Input

Select MIDI input port

---

## Output

Select MIDI output port

# Bluetooth (BLE) MIDI

## Central

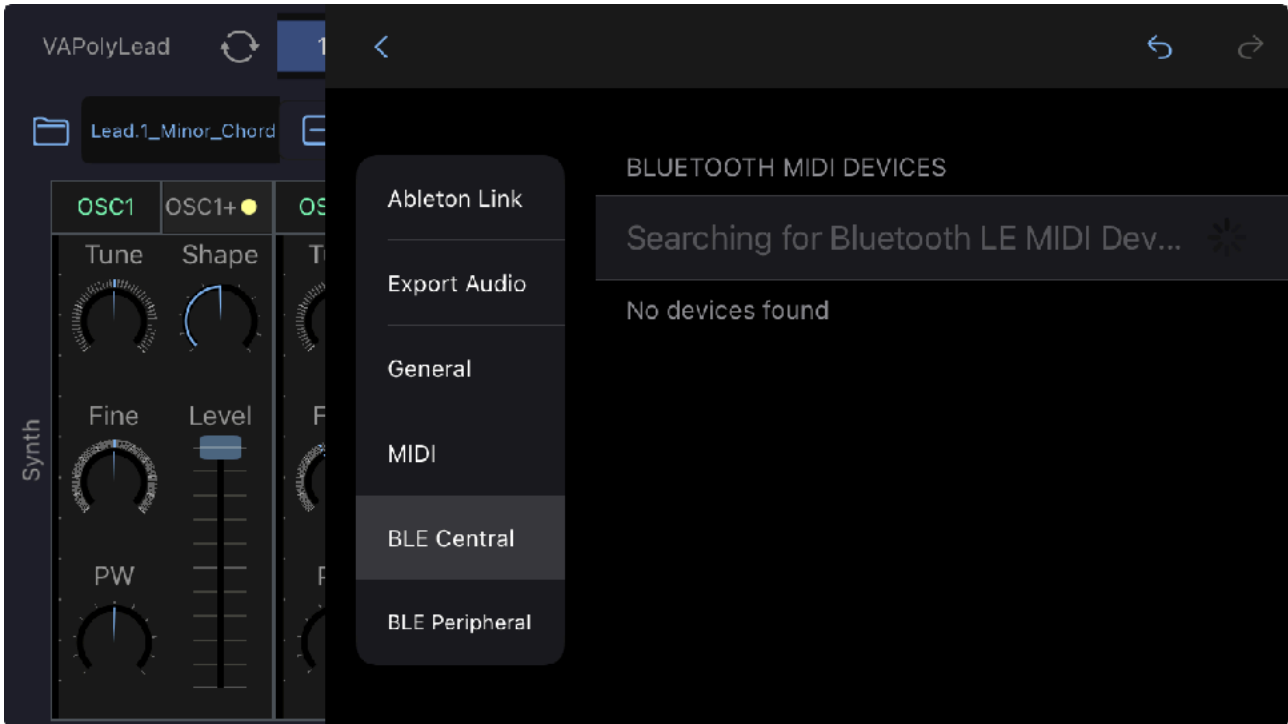

Open Bluetooth MIDI Central, which list available bluetooth devices. Select a name to connect to the device.

## Peripheral

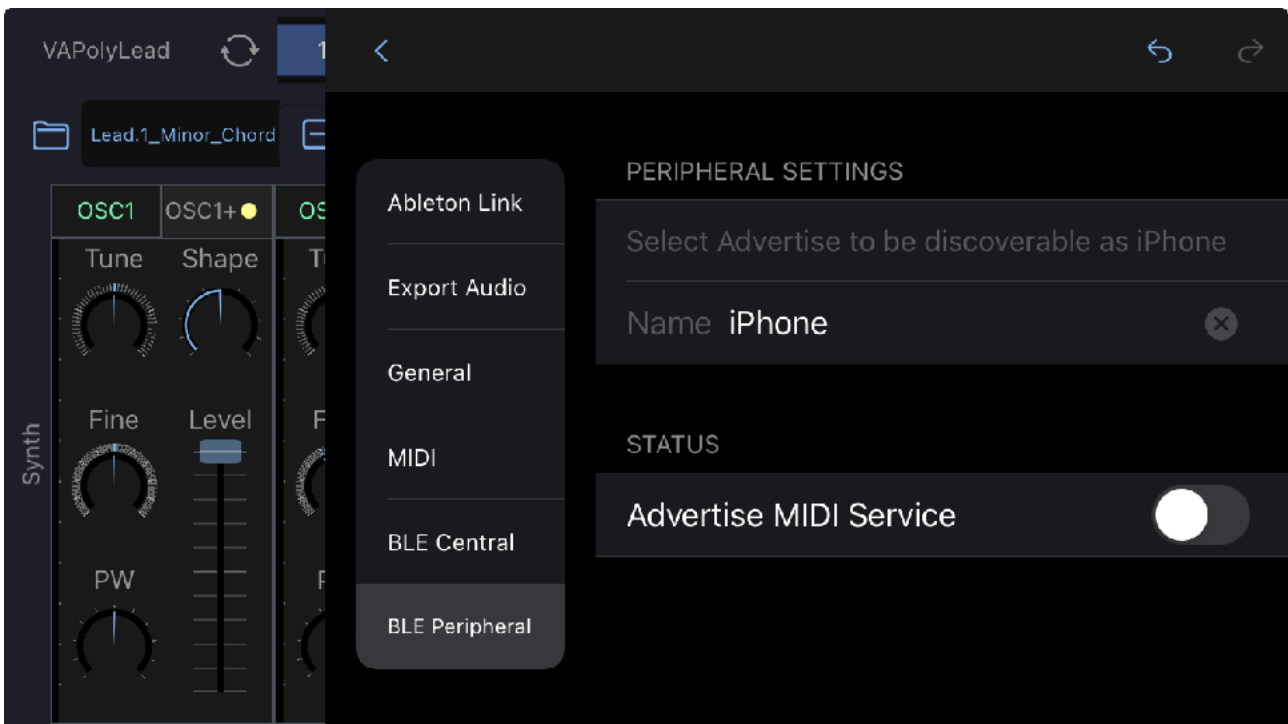

Open Bluetooth MIDI Peripheral. Turn Advertise MIDI Service switch on to makes the device to be discoverable from the other Bluetooth MIDI devices.

# Export Audio

## Prepare for exporting audio

---

### 1. Stop playback

Make sure the playback is stopped.

---

### 2. Select the first clip to play

Open clip editor and select a clip which should be played at first.

---

### 3. Turn off metronome

Make sure that metronome is turned off.

## Adjust export settings

---

### 1. Save As

Type in file name if necessary.

---

### 2. Length

Set total length of the recordings by number of bars. This length should include the length of the delay or reverb tail.

---

### 3. Location

Select location to save the file. Options are local and iCloud.

---

### 4. File Type

Select a file type. Options for linear PCM format are AIFF, WAV or CAF. For compressed audio file, choose AAC. If the exported audio file is going to be edited in a different application, it is recommended to choose linear PCM format.

---

### 5. Sample Rate

Select sample rate. Options are 44.1KHz, 48KHz, 88.2KHz and 96KHz.

---

### 6. Bit Depth

Select bit depth. Options are 16 bit, 24 bit and 32 bit. Higher number results in better quality. If the exported file is going to be used in a different application, make sure that the which bit depth of the selected file type is supported by the application. (\* 32 bit may not be supported in some applications).

## Export Audio File

Tap export button to generate audio file and save the file in the specified location. When exporting the file is completed, browser can be open to audition the exported file.

## Map MIDI CC

Tap “Map MIDI CC” in “MIDI Global” of the setting panel to show MIDI CC Map View. Use “Synth” button in tool bar to select a synth section or effects to map MIDI CC. Tap “Hide MIDI CC” in “MIDI Global” of setting panel to close MIDI CC Map View.



To make a MIDI CC (Continuous Controller) assignment, Tap a button then turn a knob on MIDI controller. The first MIDI CC number detected will be assigned to the parameter.

When CC is assigned, the button shows the CC number.

To cancel the assignment or to remove the mapping, tap the button.

To remove all assignments, select “Rest MIDI CC Map” in MIDI Global of the setting panel.

All the MIDI CC assignments are restored when app is launched in the next time.

## Override Automation

When a parameter is controlled by MIDI controller, it is not possible to automatically override automation. To override, turn off automation switch of the parameter or turn the dial of the parameter on screen that will stop the automation and the parameter can be controlled freely by MIDI controller.

## MIDI Program Change

Program Change is received as following.

Factory: Bank (CC#0) = 0, Sub (CC#32) , Preset Number = Sub \* 128 + Program  
Plugin: Bank (CC#0) = 1, Sub (CC#32) , Preset Number = Sub \* 128 + Program

Presets stored in iCloud Drive can't be selected by the MIDI program change.

## **Use External MIDI Keyboard with Stand Alone**

1. Open host setting
2. Select MIDI from side bar menu. Set input MIDI port and output MIDI port.
3. Close host setting
4. Select MIDI Synth1 from side bar menu. Make sure “Receive” switch is turned on. Adjust channel and note range.
5. To stop hanging note, select MIDI Global from side bar menu, Tap on “All Note Off”.

## **Use MIDI Foot Pedal**

CC#11 and CC#64 are supported for MIDI Foot Pedal. Targets of Expression can be selected in KBD Control Routing Panel. Sustain switch can be used to sustain currently played note.

## Undo / Redo



1. Tap Undo / Redo button. Tap Undo to undo previous operation. Tap Redo to redo previous undo operation.

\* Some operation such as play, stop or record are excluded from undo / redo operation.

\* On macOS, turn on “Musical Typing” to enable keyboard shortcut, command + z for undo and shift + command + z for redo.

# macOS

Stand Alone on macOS supports menu bar, keyboard shortcuts, context menu and touch bar. AUv3 plug-in on macOS supports keyboard shortcuts and context menu.

## Menu Bar



---

## Application

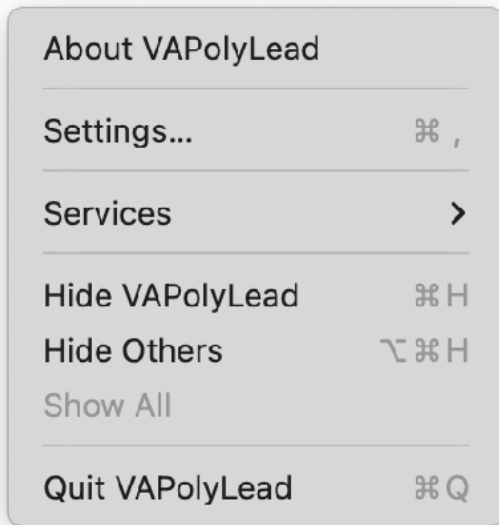

Open a window to display version information.

Open Preference window.

Quit this application.

---

## File

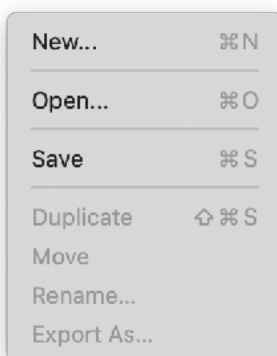

Reset all parameters and sequence data.

Open a preset from iCloud drive.

Save a preset to iCloud drive.

---

## Edit



Edit Commands are enabled when typing text.

---

## View

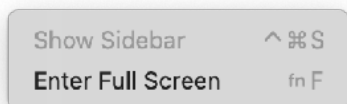

Enable/disable full screen mode.

---

## Export

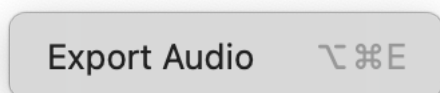

Open Export Audio Page in Setting Panel.

---

# Window

- Minimize ⌘ M
- Zoom
- Tile Window to Left of Screen
- Tile Window to Right of Screen
- Replace Tiled Window

---

- Remove Window from Set

---

- Move to  iPad

---

- Bring All to Front

---

- ✓ VAPolyLead

---

# Help

Search

VAPolyLead Help

## Preference

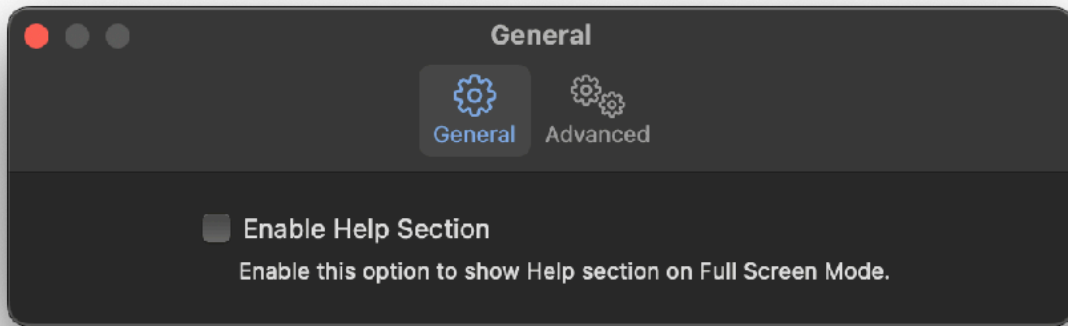

---

### Enable Help Section

Enable this option to show Help Section on Full Screen Mode.

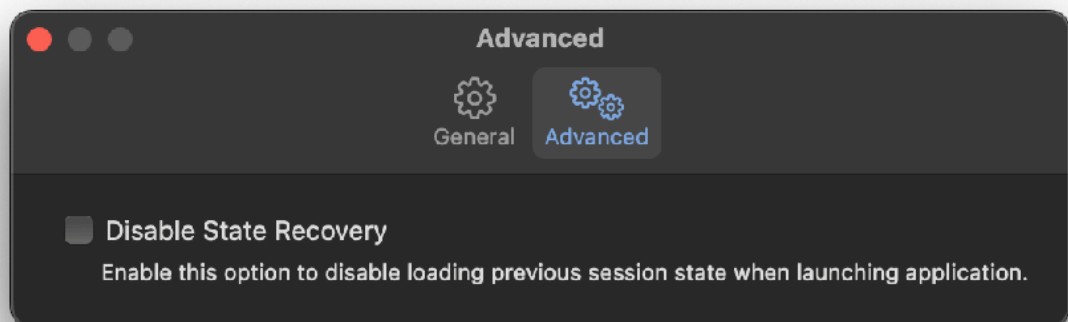

---

### Disable State Recovery

When application is launched, state of the previous session is automatically loaded by default. Check this option to disable state recovery, so the application always start in default state.

## Touch Bar (MacBook Pro)



---

### 1. Play / Stop

Tap to play / stop sequencer

---

### 2. Tempo

Adjust tempo. Range of the slider is from 20 BPM to 240 BPM.

# Use Computer Keyboard as MIDI Keyboard

Enable Musical Typing option in setting.

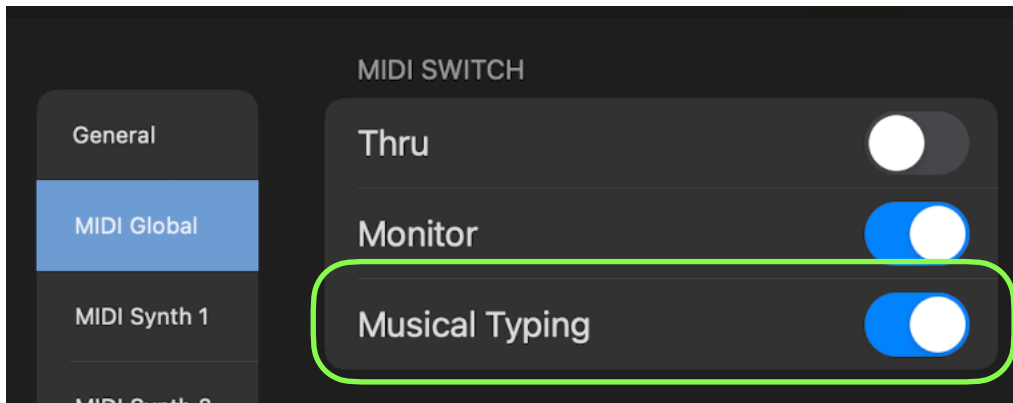

Keys are mapped as shown in the figure below.

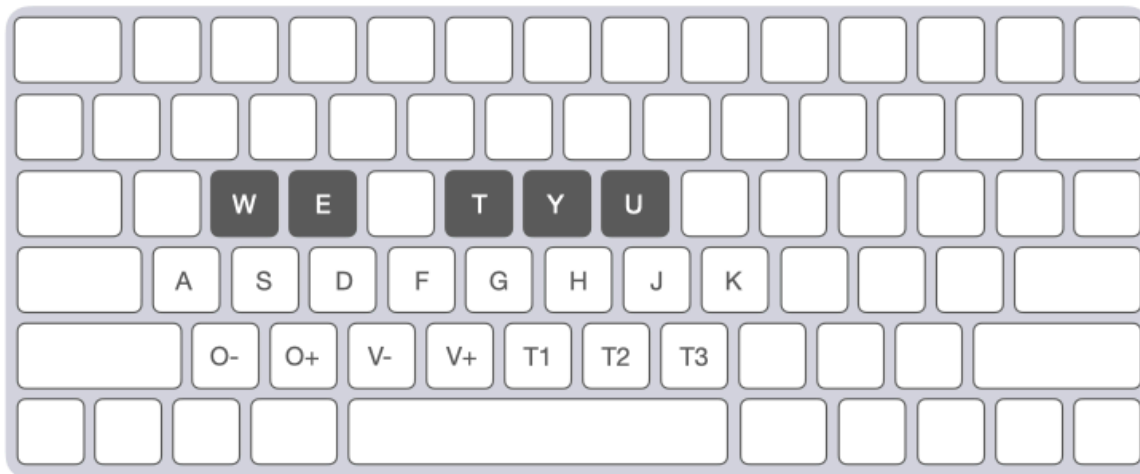

## Change Octave

[O-] Press Z key to select one octave below.  
[O+] Press X key to select one octave above.

## Change Velocity

[V-] Press C key to decrease velocity.  
[V+] Press V key to increase velocity.

## Set Timbral

[T1] Press B key to select Layer.  
[T2] Press N key to select Synth1.  
[T3] Press M key to select Synth2.

## Keyboard Shortcut

Command	Key	AUv3	Note
New	Command-N	N/A	
Open	Command-O	N/A	
Save	Command-S	N/A	
Undo	Command-Z	✓	
Redo	Shift-Command-Z	✓	
Cut	Command-X	✓	Available for Text Input
Copy	Command-C	?	
Paste	Command-V	?	
Delete	Command-Delete	?	
Select All	Command-A	?	
Enter/Exit Full Screen	fn-F	N/A	
Play/Stop	Space	?	
Change Focus	Tab	?	
List Up	Arrow-Up	?	
List Down	Arrow-Down	?	
List Select	Enter	?	

? : (AUv3) Availability is depends on the host application, which can disable these functions.

\* Some of the keyboard shortcut will be available in the future version update.

# AUv3 on Apple Garage Band (Mac)

## Load Plug-in

1. Launch GarageBand.
2. Choose a project dialogue window appears. Select a project and click on Choose.

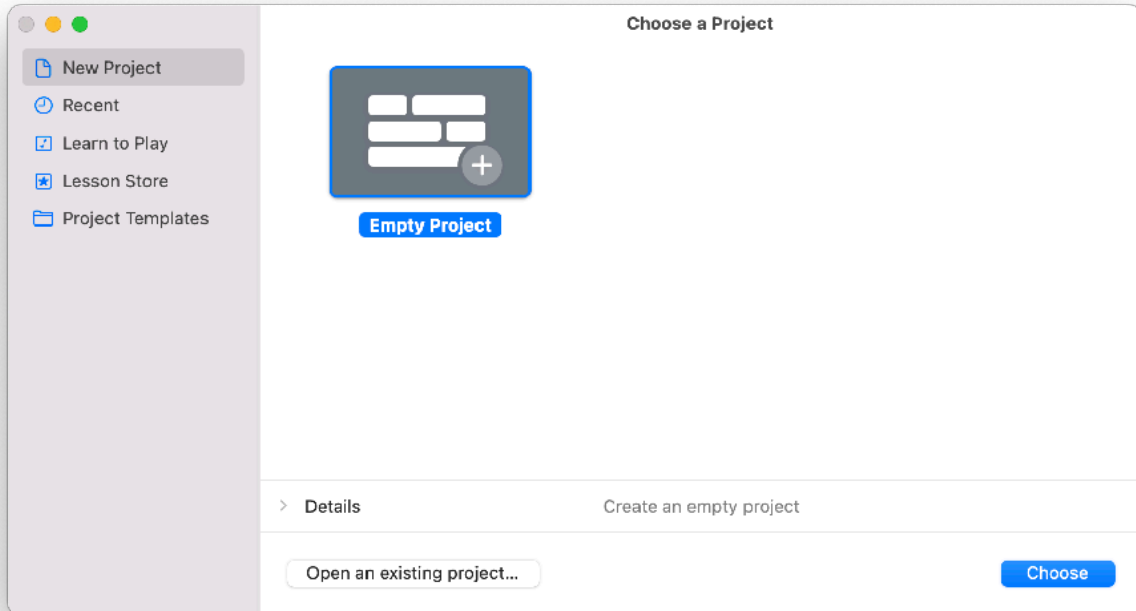

3. Choose a track type dialogue appears. Select Software Instrument and click Create.

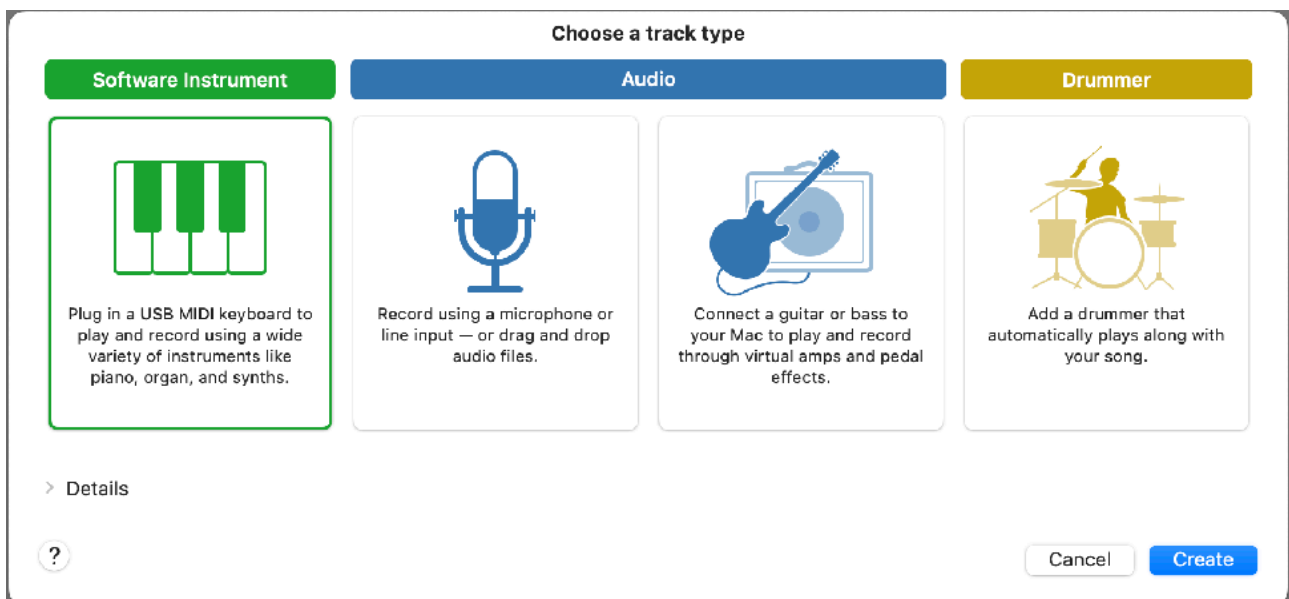

4. Click Plug-ins in Track Section.

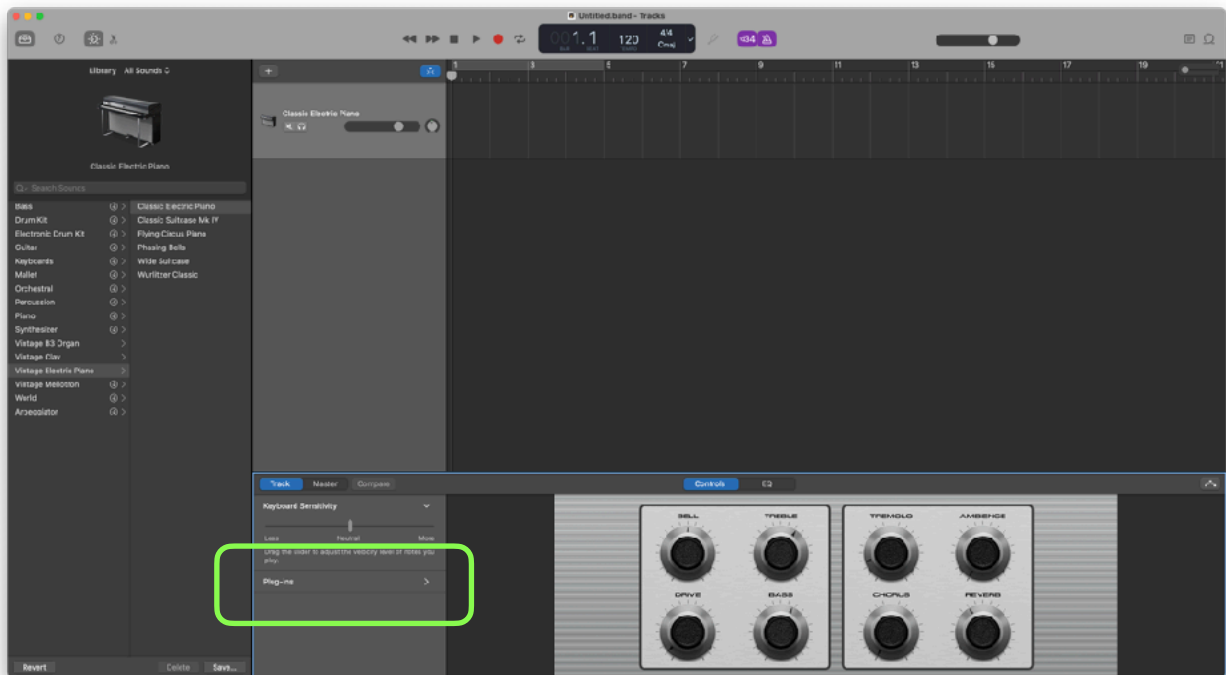

5. Click arrows at the right side of the blue button “E-Piano”.

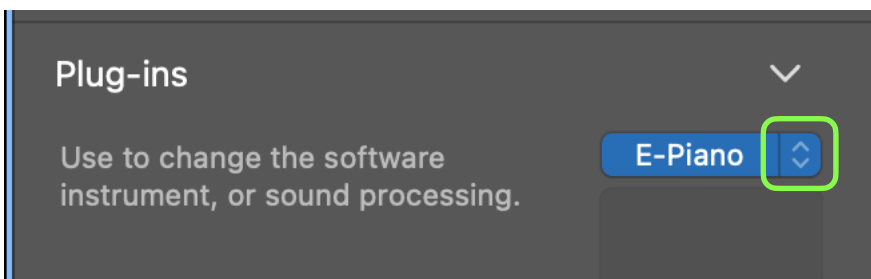

6. Select AU Instruments > RTMS > VAPolyLead

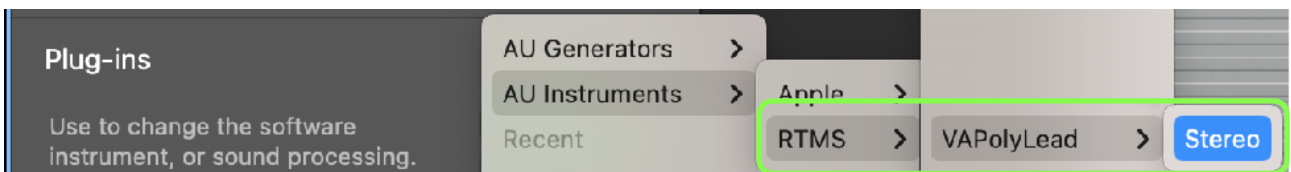

7. If plug-in window doesn't displayed. Tap blue button.

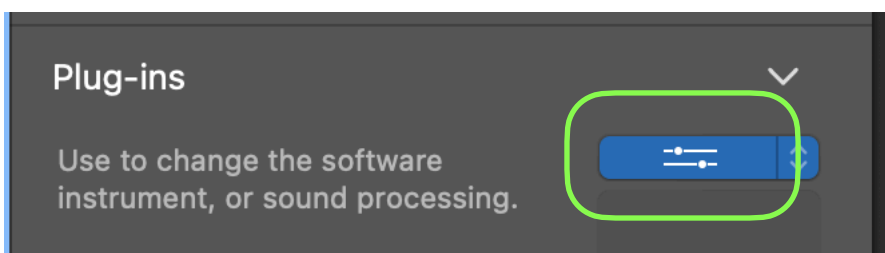

## Activate Plug-In

After loading VAPolyLead or opening a project file, DSP engine of VAPolyLead may not be running.

In order to start the DSP engine, please do one of the followings.

- Press Play button on GarageBand.
- Play MIDI notes from GarageBand.

To play midi note by computer keyboard, select “Window > Show Musical Typing” from menu bar of the Garage Band. While the Musical Typing window is displayed, type A for note C.

## Offline Renering

To start Offline Rendering on Apple Garage Band, select Cycle Range and select “Share > Export Song to Disk” from menu bar of the Garage Band. Selected Cycle Range will be rendered.

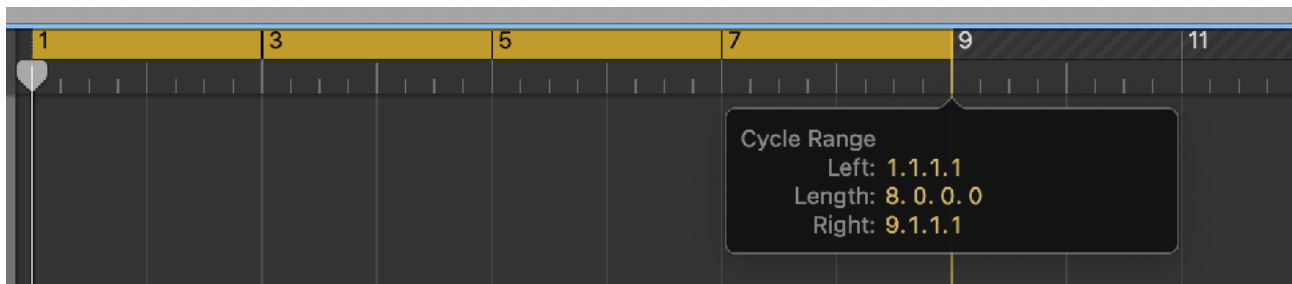

The followings are a few tips for offline rendering on Apple Garage Band.

- Make sure to save your project before performing offline rendering.
- Audition before initiating offline rendering. In order to perform offline rendering, DSP engine of VAPolyLead needs to be running. Please press play on GarageBand and make sure that DSP engine is running.
- If you are using clips, add an empty clip at the end and set the length to INF. Garage Band will stop rendering when audio level is dropped to inaudible level. This helps to record tail of the delay or reverb effect.

## Known Limitations

- DSP Engine doesn't start until a user presses play button or play MIDI notes on GarageBand.
- Touch Bar shows blanc screen when showing button menu or context menu.
- GarageBand doesn't record MIDI notes from keyboards or sequencer of the VAPolyLead plugin.

# AUv3 on Apple Garage Band (iOS)

## Load Plug-in

1. Launch Garage Band
2. Create a new song

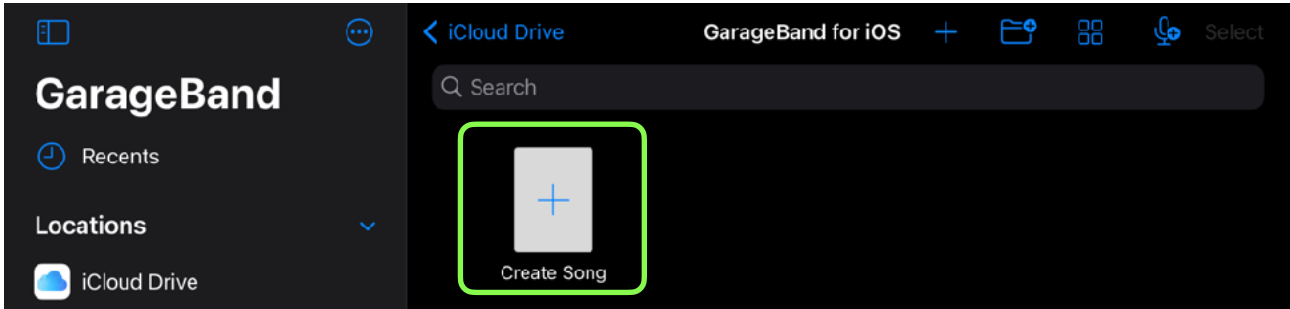

3. Select External > Audio Unit Extension

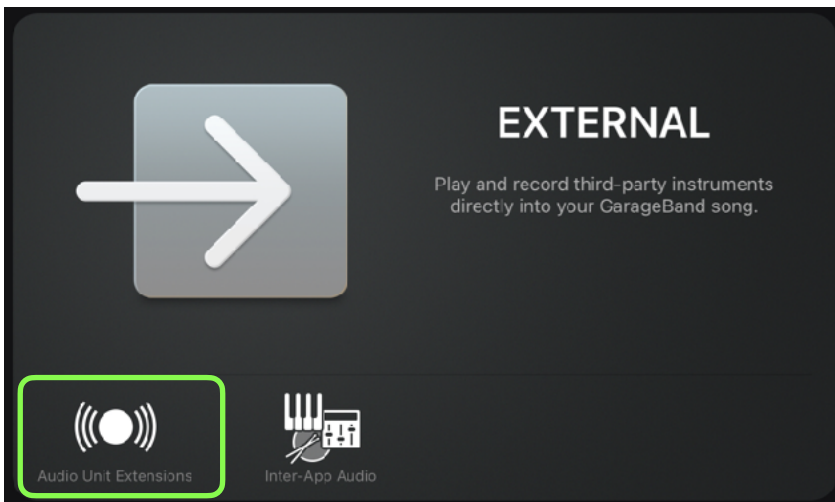

4. Select VAPolyLead

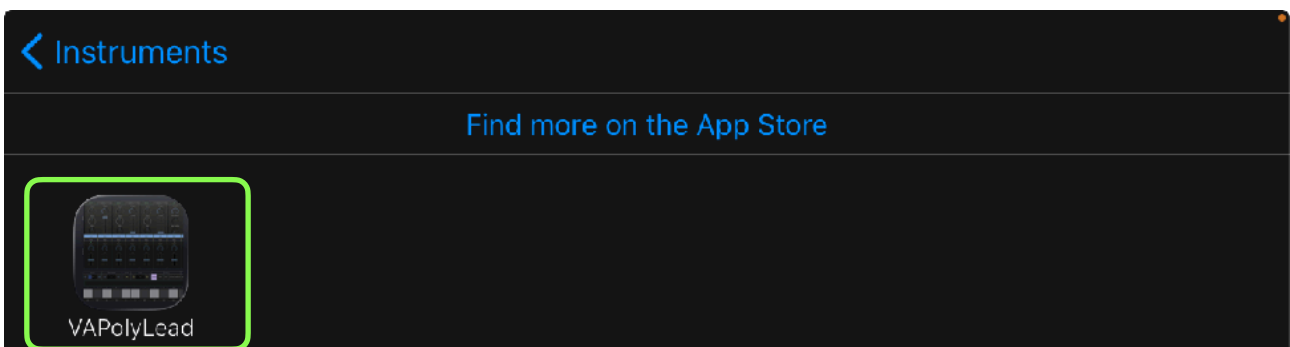

# Change Plug-in Window Size

Tap arrow icon to resize the plug-in window.



## Record Notes

Tap record button and play keyboard.



## Edit Notes

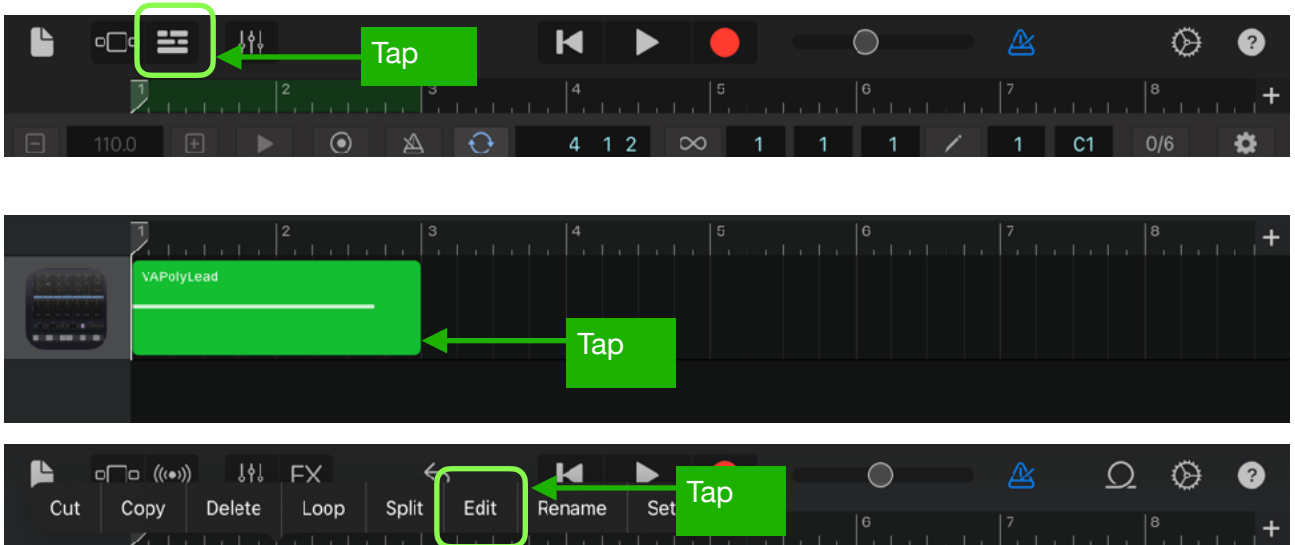

Select Edit from menu and edit notes. Tap “Done” to close the window.

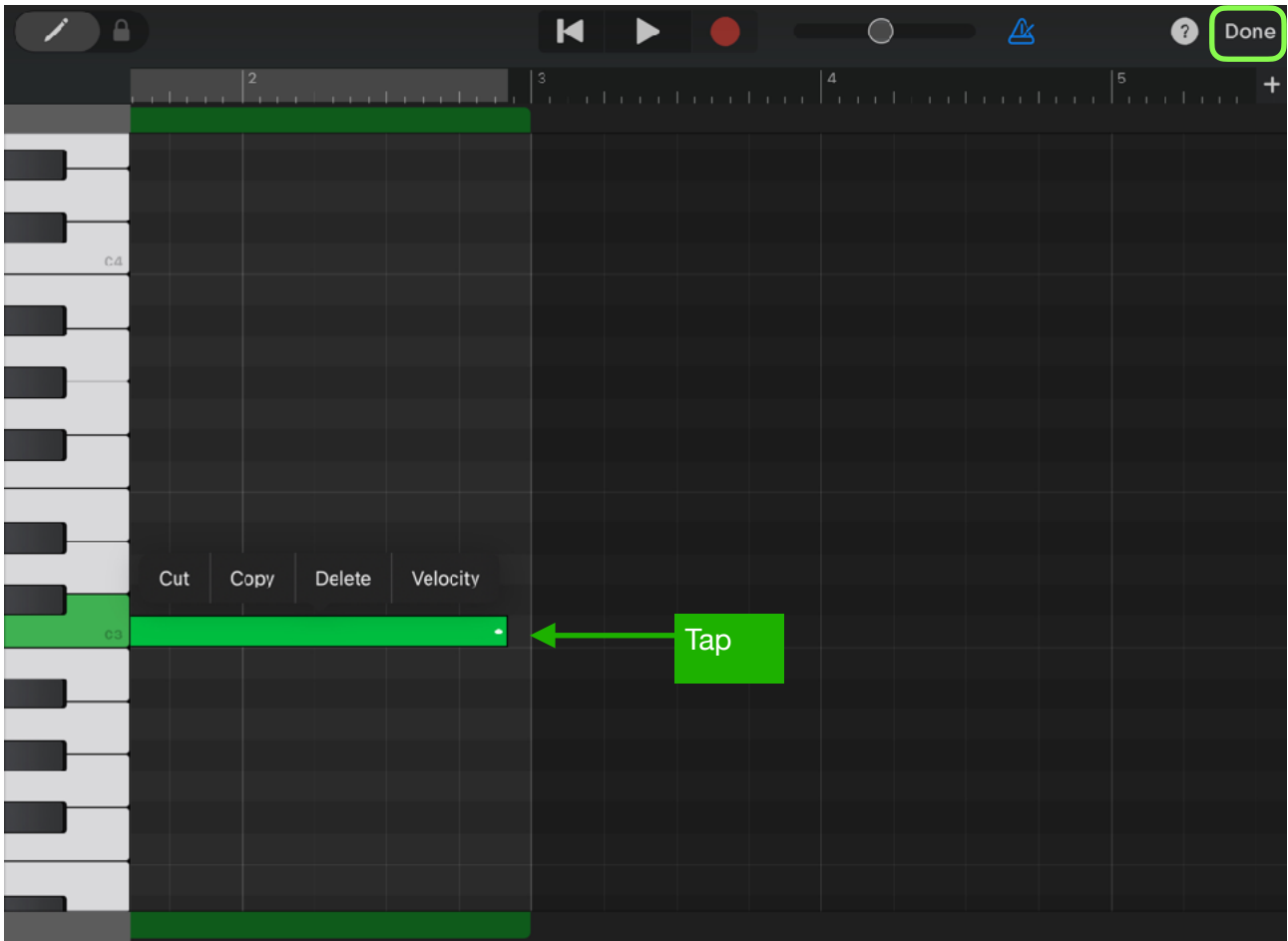

## Save Project

Tap document icon to save the song.

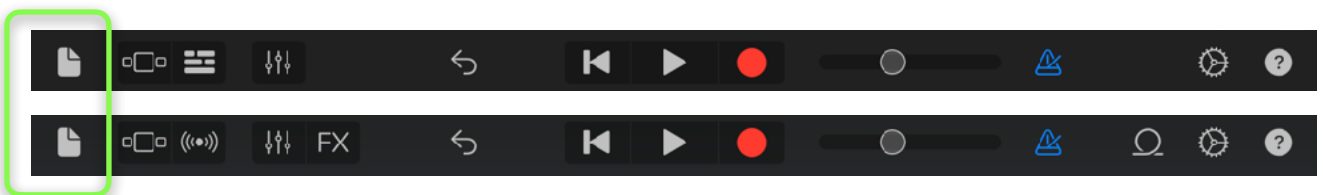

## Host Sync

Tap Host Sync button to sync transport and tempo to host application.

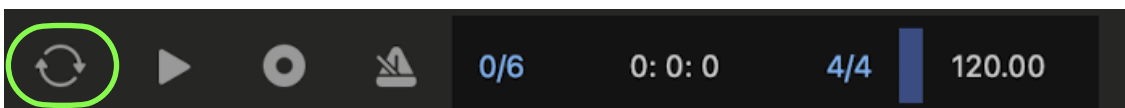

To disable transport sync, tap and hold sync button and select “Disable Transport Sync” from menu.

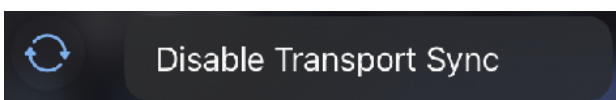

# System Interruptions (iOS)

It is important to aware that system may interrupt playback in the following situations. Please make sure to test and make a plan to handle the situations.

## 1. Incoming calls or activating Siri

When receiving an incoming call or when activating Siri, it interrupts playback and send App to background. In order to avoid it occurs, turn off the followings in the Setting App.

- Do Not Disturb > Do Not Disturb > turn on.
- Siri & Search > Listen for “Hey Siri” > turn off.
- Siri & Search > Press Home for “Siri” > turn off.

## 2. Connecting or disconnecting a headphone

Headphone output has own DAC<sup>5</sup> and own sample rate. The sample rate may be different form the sample rate of the audio engine. What will happens when connecting or disconnecting a headphone depends on the sample rates.

If the sample rates are same, playback continues when headphone is connected. When headphone is unplugged, playback will stop. You can change this behavior by turn Resume when headphone is unplugged on in Settings.

If sample rates are different, when connecting headphone or when disconnecting headphone stops playback and system will re-configure audio engine for the new sample rate.

The sample rate of the audio engine is set by an application or an audio interface. For example, when connecting an iOS device to Mac using a cable that came with your device, Inter Device Audio and MIDI on macOS uses 44.1KHz but Quicktime player app on macOS uses 48KHz.

If you are planning to connecting or disconnecting headphone for monitoring during playback, please make sure to test and learn what will occurs.

## 3. Changing sample rate setting

As described above, if sample rate of the audio engine is changed for any reasons, playback stops.

## 4. Media Reset

Under rare circumstances, the system terminates and restarts its media services daemon. When it occurs playback stops.

## 5. Pressing the Home button or sending App to background

When app is sent to background by pressing home button, showing notification center or any other reasons, playback stops. You can change this behavior by turn Run in Background on in Settings.

## Additional Settings

Followings are other settings in the Settings App which you may want to adjusted.

- Display & Brightness > Auto-Lock > set to Never
- Sounds > turn off all system sound
- Notifications > Show Previews > set to Never
- Home Screen & Dock > Multitasking > Gestures > turn off

If you have installed apps that may send you a notifications or may interrupt playback, make sure to adjust settings of the apps to disable the functions.

If you are using Ableton Link, make sure that Local Network in Privacy is turned on. If you are using Bluetooth MIDI, make sure that Bluetooth in Privacy is turned on.

---

<sup>5</sup> Digital to Analog Converter

# Specification

## Synthesizer

- Polyphonic Synthesizer

## Oscillator 1, 2 & 3

- Continuously variable wave shape (triangle, sawtooth, square)
- Pulse width for square
- Tuning +/- 24 semitones
- Fine tuning +/- 50 cents
- Frequency Modulation (Exponential) +/- 4 octaves
- Pulse Width Modulation

## Filter

- Low pass filter: -12 dB per octave
- High pass filter: -6 dB per octave
- Frequency modulation: ADSR, LFO, Key Follow

## Amplifier

- Envelope: ADSR
- Amplitude modulation: LFO
- Pan modulation: LFO

## LFO

- Wave shape: sine, saw, down saw, square, triangle, random
- Frequency Range: From 0.04Hz to 42.2Hz

## ADSR Envelope

- Attack time: From 1ms to 6 sec
- Decay time: From 1ms to 10 sec
- Sustain level: From 0 to 100%
- Release time: From 1ms to 10 sec
- Delay time: From 0ms to 10 sec
- Key Follow: From 100% to 25% (envelope length)

## Step Sequencer (Analog Style)

- 8 Steps
- Sample & Hold
- Clock Frequency: From 1 Hz to 20 Hz

## Controllers

- Modulation Wheel, Pitch Bend Wheel, Ribbon Control

## Effects

- Delay, Chorus, Flanger, Reverb, EQ and Compressor

## Sequencer (Piano Roll)

- Steps: 16 steps per bar
- Loop Length: from 1 bar to 16 bars
- Clip: 8 clips
- Tempo: from 20 BPM to 999 BPM
- Host Sync: On and Off

## Delay

Delay Time	Range from 20ms to 1200ms
Feedback	Range from 0% to 100%
Highpass Filter	Range from 20Hz to 500Hz
Lowpass Filter	Range from 1000Hz to 20000Hz
LFO Frequency	Range from 0.01Hz to 10Hz
LFO Intensity	Range from 0.0 to 1.0 (from 0ms to +/- 10ms)
Effect Switch	ON or OFF
Sync Switch	ON or OFF
Frequency Range	From 0Hz to 22.05KHz (effect)

## Chorus / Flanger

Delay Time	Range from 1ms to 40ms (chorus), from 1ms to 13ms / 20ms (flanger)
Feedback	Range from 0% to 100% (flanger)
Highpass Filter	Range from 20Hz to 500Hz
Lowpass Filter	Range from 1000Hz to 20000Hz
LFO Frequency	Range from 0.01Hz to 10Hz
LFO Intensity	Range from 0.0 to 1.0 Chorus: from 0ms to +/- 1ms Flanger: from 0ms to 12ms / 19ms / 39ms
Effect Switch	ON or OFF
Sync Switch	ON or OFF
Effect Selector	Chorus or Flanger
Frequency Range	From 0Hz to 22.05KHz (effect)

## Reverb

Input lowpass filter	Range from 1KHz to 20KHz
Input high-pass filter	Range from 20Hz to 500Hz
LFO Frequency	Range from 0.01Hz to 10Hz
LFO Intensity	Range from 0.0 to 1.0
Pre Delay	Range from 1ms to 100ms
Size	Range from 0% to 100%
Auto Size Mode	ON or OFF
Decay	Range from 0% to 100%

Damp	Range from 0% to 100%
Output Lowpass Filter	Range from 1KHz to 20KHz
Early/Late Mix	Range from 0% to 100%
Tempo Sync	ON or OFF
Effect Switch	ON or OFF

### Equalizer

Low Shelving	Frequency Range	Range from 21Hz to 1092Hz
	Gain	Range from -INF to +12dB
	High Pass Filter response	12dB / Oct
Mid Peak / Notch	Frequency Range	Range from 151Hz to 2389Hz
	Gain	Range from -14dB to +14dB
	Bandwidth	1 octave
High Shelving	Frequency Range	Range from 296Hz to 21096Hz
	Gain	Range from -INF to +12dB
	Low Pass Filter response	12dB / Oct

### Compressor

Input Gain	Range from -20dB to 20dB
Input High Pass Frequency	Range from 20Hz to 185Hz
Threshold	Range from -40dB to 0dB
Makeup Gain	Range from 0dB to 20dB
Ratio	2, 4, 10
Attack	0.01ms, 0.1ms, 0.3ms, 1ms, 3ms, 10ms, 30ms
Release	0.1s, 0.3s, 0.6s, 1.2s, Auto
Dry / Wet	Range from 0% to 100%

\*Appearance and specification of the product are subject to change without notice.

## Release Notes

### What's new in version 1.0

- Initial release

### What's new in version 1.0.1

- Version 1.0.1 contains bug fixes and improvements.